



Infraestructura e Industria

Tarifa 2024
Marzo 2024





Editorial

Otro año más, otra tarifa más, y una nueva oportunidad para agradecer la confianza depositada en Aliaxis y en todas nuestras marcas.

Sin vosotros, este proyecto de innovación, crecimiento y sostenibilidad que es Aliaxis no sería posible.

Creo que estamos todos un poco cansados de hablar de incertidumbre, volatilidad, inflación..., por eso, voy a hablaros de cariño y positivismo, sí, del cariño y positivismo que vivimos en Aliaxis, y con el que diseñamos y construimos este catálogo.

En Aliaxis, apostamos por la innovación, por la sostenibilidad y por el servicio. Nuestro objetivo es ayudaros a dar soluciones fiables a vuestros clientes con las que crecer. Por eso, os ponemos en el centro de nuestras decisiones y buscamos que cada proyecto tenga impacto POSITIVO en vosotros.

Entre 2022 y 2023 hemos invertido más de 14 millones de euros, y tenemos planes de inversión que superarán estas cifras. Todo ello para mejorar nuestras fábricas y desarrollar nuevas soluciones sostenibles que ayuden al planeta.

Hoy;

- ✓ Ya usamos un 22% de energía renovable de autoconsumo en nuestras plantas y llegaremos al 100% en 2025.
- ✓ Hemos reducido el 12% de nuestras emisiones de CO2.
- ✓ Hemos reducido el consumo de agua un 30% y queremos llegar el 50% en 2024.
- ✓ Tenemos la certificación OCS en Alicante y la tendremos en nuestra planta de Álava para antes del primer trimestre de 2024.
- ✓ Tenemos el objetivo de cero residuos a vertedero, que alcanzaremos durante el 2024.
- ✓ Hemos lanzado el primer sifón hecho íntegramente 100% con polipropileno reciclado, y con un envase de cartón 100% reciclado.
- ✓ Hemos incorporado ZYPHO a la familia de Aliaxis, y presentamos al mercado el recuperador de energía térmica más eficiente, con reducción de hasta un 75% del consumo de energía en el agua caliente de la ducha.
- ✓ Hemos lanzado la nueva gama de tubería y accesorios PPH
- ✓ Hemos lanzado el primer portal para distribuidores on-line "Mi Aliaxis" con vosotros y seguiremos añadiendo funcionalidades nuevas en 2024
- ✓ Hemos invertido en formación de nuestro equipo humano para garantizar que el cuidado y la atención experta a vosotros sea un hecho diferencial de nuestra empresa y nuestra marca.

Y muchos más proyectos que estamos desarrollando y de los que os haremos partícipes.

Si como dijo alguien, la economía es un estado de ánimo, junto con vosotros, y GRACIAS VOSOTROS, vamos a hacer de 2024 un año muy POSITIVO.

Con cariño y enorme agradecimiento, os envío un afectuoso saludo,

Jorge Barranco

Vicepresidente Aliaxis Iberia

Bienvenido a

aliaxis

El cambio positivo que se hace realidad

En Aliaxis, nuestro propósito es brindar soluciones a los desafíos hídricos del mundo y acelerar la transición hacia la energía limpia.

Líderes en el sector

Ya son más de cinco décadas de experiencia en 4 segmentos clave:



EDIFICACIÓN



INFRAESTRUCTURA



INDUSTRIA

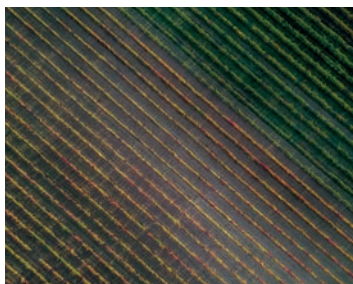

AGRICULTURA



Escanea el código para descargar las tarifas de:

- Edificación y Riego
- Infraestructura e Industria

Aliaxis: una gran compañía en expansión



Corazón local. Espíritu global

Operamos en más de 40 países y diseñamos soluciones sostenibles, fáciles de instalar e innovadoras.

Gracias a nuestros más de 14.000 empleados, nuestros sistemas de tuberías y accesorios satisfacen las necesidades más exigentes de nuestros clientes en los sectores de construcción, infraestructura, industria y agricultura.

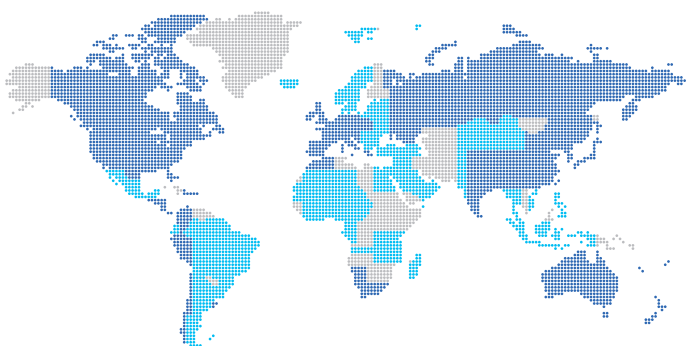

Conoce más sobre nuestras fábricas en España



Alicante

El origen de nuestras soluciones en sanitario

- + 55 años de experiencia
- 80.000 m²
- + 500 empleados



Okondo

El origen de nuestras soluciones para infraestructura

- + 30 años de experiencia
- 5.000 m²
- + 100 empleados



Para más información consulta alixis.es

FINALES DE CARRERA MECÁNICOS E INDUCTIVOS

Fácil instalación con gran versatilidad de uso, incluso en ambientes corrosivos.

AMPLIACIÓN DE GAMA



Encuétralo en:
Tarifa Infraestructura e Industria, pág. 449

ACCESORIOS PP-H

Nuevas curvas 90°.

Cuenta con 8 marcas orientables que permiten la correcta alineación en todas las direcciones del tubo durante su instalación.

Tiene una superficie interna pulida que minimiza la sedimentación de impurezas.

REDISEÑADAS Y MEJORADAS



Encuétralo en:
Tarifa Infraestructura e Industria, pág. 324

FLEXIPOL FM

Nuestras tuberías cuentan con certificado FM para instalaciones enterradas de PEAD contraincendios.

Nuevos diámetros: Ø 63 ,75 ,125 y 140 mm.

Más información en:



NUEVOS DIÁMETROS



Encuétralo en:

Tarifa Infraestructura e Industria, pág. 10

ACCESORIOS MANIPULADOS

Contamos con un taller especializado al lado de nuestra fábrica de tuberías de polietileno donde realizamos el diseño y producción de accesorios a medida.

Gracias a nuestro sistema de soldadura a tope, las uniones son resistentes y de alto rendimiento.

AMPLIACIÓN DE GAMA



Encuétralo en:

Tarifa Infraestructura e Industria, pág. 42

SIFONES FLEXIBLES DE GOMA

Muy fáciles de instalar.

Gama disponible con accesorios de válvula y racor.



Encuétralo en:

Tarifa Edificación y Riego, pág. 39

LINNUM ALTURA REDUCIDA

Con una altura de sifón de tan solo 30 mm.

Permite una instalación al ras del suelo.



Encuétralo en:

Tarifa Edificación y Riego, pág. 76

LINNUM CERCO OCULTO

En acabado negro mate y con diseño reversible.

Al voltear la rejilla obtendrás un marco rellenable que te permitirá conseguir acabados con otros materiales (cerámica, mármol, cristal, entre otros).



Encuétralo en:

Tarifa Edificación y Riego, pág. 76

VÁLVULAS CLICK CLACK

Adaptables a todo tipo de diseño gracias a la variedad de acabados, tapones y dimensiones.

Integrable a todo tipo de lavabo, hasta en aquellos de de altura reducida.

Más información en:



ENLACES DE 3 PIEZAS PP-RCT

Ampliación de gama sistema WF/PP-R agua caliente y fría.

Nuevas piezas que permiten desmontarse y hacer uniones por ambos lados, facilitando el trabajo en instalaciones encastradas.

REJILLA CONNECTO B125

La rejilla más resistente combinable con todas las canaletas de la gama CONNECTO®.

NUEVOS MODELOS



Encuétralo en:

Tarifa Edificación y Riego, pág. 12

AMPLIACIÓN DE GAMA



Encuétralo en:

Tarifa Edificación y Riego, pág. 242

NUEVO MODELO



Encuétralo en:

Tarifa Edificación y Riego, pág. 220

¿Qué servicios tenemos para ofrecerte? En Aliaxis somos las personas que cada día te damos repuesta.



Atención comercial al canal de distribución:

Estamos comprometidos a proporcionar apoyo en cada solución, ya que tenemos un equipo de profesionales listos para asesorar al canal de distribución.

El equipo comercial brinda el apoyo necesario sobre todas nuestras categorías de productos y los beneficios que estos brindan.

Solicita un asesor: vozdelcliente@aliaxis.com



Asesoramiento técnico a instaladores:

Ayudamos a instaladores en su día a día y a facilitar la planificación para su negocio. Esto se logra gracias a un **equipo de especialistas en fontanería** encargados de ofrecerles el mejor apoyo técnico.



Prescripción de proyectos de edificación:

Asesoramos a promotoras, constructoras, ingenierías y grandes instaladores en la etapa de desarrollo de sus proyectos para la selección de las mejores soluciones. Utilizamos herramientas avanzadas de diseño para lograr una asesoría personalizada, **contamos con una oficina técnica capaz de realizar cálculos**, diseños y planos como también de optimizar diseños realizados por ingenierías.

Más información: prescripcion.alicante@aliaxis.com



Atención al cliente:

Si alguien puede resolver cualquier duda que se pueda dar durante la compra y/o entrega de un pedido, ese es nuestro equipo de atención al cliente especializado en el canal de distribución.

| | |
|---------------------------------|--|
| Pedidos Industria | pedidos.iberia@aliaxis.com |
| Pedidos Infraestructura | pedidos.infra@aliaxis.com vozdelcliente.infra@aliaxis.com |
| Pedidos Edificación | pedidos.iberia@aliaxis.com vozdelcliente@aliaxis.com |
| Teléfono de atención al cliente | 965 111 290 |
| Horario de atención al cliente | de Lunes a Jueves: de 8.00 a 17.00 Viernes : de 8.00 a 14.30 |



SAT:

Contamos con un equipo de expertos que brindan soporte técnico post venta para productos específicos como para depuradoras y trituradores.



Índice

Infraestructura

| | | | |
|--|-----------|---|------------|
| 1 Tubería de PE | 7 | 7 Equipos y herramientas Friatools | 75 |
| Tubería para agua | 8 | Máquinas de soldadura | 76 |
| Flexipol PE100 / FM / RD / RC / RT | | Rascadores | 80 |
| Flexipol PE100 ranurado/perforado | | Accesorios y herramientas | 85 |
| Excel-Plus | | | |
| Tubería para gas | 15 | 8 Accesorios de PE inyectados largos | 89 |
| Gasypol PE100 RC | | | |
| Tubería para telecomunicaciones y alta tensión | | 9 Accesorios de PE inyectados cortos | 103 |
| | | | |
| 2 Magnum 3G | 17 | 10 Accesorios metálicos | 113 |
| Fitting para tubo de PE | 18 | Uniones y adaptadores brida | 116 |
| Fitting con inserto de latón | 23 | Carretes de desmontaje | 129 |
| Fitting UTC/PE | 24 | Abrazaderas de reparación | 130 |
| Fitting alta resistencia química HCR | 26 | | |
| Válvulas para contador HCR | 28 | 11 Válvulas y accesorios de fundición | 133 |
| Repuestos | 29 | Válvulas | 134 |
| | | Trampillones | 137 |
| 3 Fitting Astore | 31 | Accesorios | 141 |
| Accesorios en PP para tubería de PE | | Ventosas | 142 |
| Codos | 32 | Hidrantes y bocas de riego | 144 |
| Máquinas de soldadura | 33 | Collarines, abrazaderas, tomas en carga | 145 |
| Enlaces | 34 | Bridas | 147 |
| Tapones / Llaves de apriete | 35 | | |
| Collarines | 36 | 12 Accesorios para saneamiento enterrado PVC | 149 |
| | | | |
| 4 Accesorios manipulados de PE | 41 | | |
| | | | |
| 5 Pasamuros y juntas | 53 | | |
| | | | |
| 6 Accesorios electrosoldables Frialen | 57 | | |
| Accesorios electrosoldables PE | 58 | | |
| Tomas simples | 68 | | |
| Tomas en carga | 69 | | |
| Válvulas PE para agua y gas | 73 | | |

Industria

| | | | |
|--|------------|--|------------|
| 13 Tubería de PVC-U presión 0802 | 155 | 19 Sistema PP-H socket 0805 | 287 |
| 14 Accesorios de PVC-U presión 0801 | 157 | Tubo y accesorios | 290 |
| Accesorios encolados, mixtos y roscados | | Válvulas manuales | 294 |
| Bridas y adaptadores | 166 | Válvulas actuadas | 303 |
| Uniones 3 piezas | 173 | Válvulas de control de presión | 319 |
| Soportes y abrazaderas | 175 | 20 Sistema PP-H testa/butt welding 0805 | 321 |
| Adhesivos y disolventes | 175 | Accesorios | 324 |
| 15 Válvulas manuales de PVC-U presión 0802 | 177 | 21 Sistema PVDF 0807 | 333 |
| Válvulas de bola 2 vías | 186 | Tubo y accesorios | 336 |
| Válvulas de bola 3 vías | 191 | Válvulas manuales | 338 |
| Válvulas de mariposa | 192 | Válvulas actuadas | 345 |
| Válvulas y grifos de membrana | 195 | Válvulas de control de presión | 354 |
| Válvulas de retención | 198 | 22 Sistema C-PVC 0806 | 357 |
| Filtros inclinados | 201 | Tubo y accesorios | 360 |
| 16 Válvulas de solenoide 0904 | 203 | Válvulas manuales | 364 |
| 17 Válvulas motorizadas de PVC-U presión 0808 | 207 | Válvulas actuadas | 371 |
| Válvulas de bola actuadas | 212 | 23 Accesorios mecánicos para la unión de tuberías - Straub 0810 | 385 |
| Válvula de 3 vías actuadas | 216 | 24 Recambios 0811 | 437 |
| Válvulas de mariposa | 217 | Conectores | 440 |
| Válvulas de membrana | 223 | Accesorios para válvulas manuales | 441 |
| Válvulas de control de presión | 229 | Actuadores y accesorios | 444 |
| 18 Medición 0803 | 231 | Accesorios y válvulas de membrana 0809 | 448 |
| Flujómetros modelo corto | 234 | Recambios | 452 |
| Flujómetros modelo largo | 251 | | |
| Medidores electrónicos de caudal | 269 | | |
| Sensores de caudal | 272 | | |
| Electrodos de PH y ORP | 276 | | |
| Sensores y transmisores de conductividad | 278 | | |
| Accesorios de instalación y recambios | 280 | | |

1

2

3

4

5

6

7

8

9

10

11

12

13

14

15

16

17

18

19

20

21

22

23

24



Tubería para agua

Flexipol PE100 / FM / RD / RC / RT
Flexipol PE100 ranurado/perforado
Excel-Plus®

Tubería para gas

Gasypol PE100 RC

Tubería para telecomunicaciones y alta tensión



Tubería de Polietileno

INFRAESTRUCTURA





Tubería de Polietileno para agua

Flexipol PE100 / FM / RD / RC / RT



FLEXIPOL - MASA TUBOS DE POLIETILENO PE100

Conducción de Agua a Presión
Fabricados según Norma UNE-EN 12201

COLOR Y APLICACIONES

Negro Banda Azul: Agua Potable
Negro-Negro Banda Marrón: Agua no Potable (Aguas Industriales-Saneamiento)
Negro Banda Morada: Agua no Potable (Agua Reciclada)

MARCAJE:

MASA FLEXIPOL

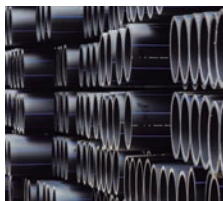

Declaración de cumplimiento Hessel con la PAS 1075 disponible.

FORMATO DE SUMINISTROS*:

Hasta Ø 90 en rollos de 100 metros
Ø 110 en rollos de 50 metros y 100 metros
Desde Ø 20 hasta Ø 110 barras de 6 metros
Desde Ø 90 hasta Ø280 en barras de 12 metros
Desde Ø 315 hasta Ø 1000 en barras de 13 metros

PN10 / SDR 17 Barras

| Ref. | Ø Ext. | Long. | Barras /Palet | €/m |
|--------------|--------|-------|---------------|--------|
| 059063010116 | 63 | 6 | 131 | 4,11 |
| 059075010116 | 75 | 6 | 100 | 7,23 |
| 059090010116 | 90 | 6 | 63 | 9,43 |
| 059110010116 | 110 | 6 | 60 | 13,87 |
| 059110010115 | 110 | 12 | 60 | 13,87 |
| 059125010116 | 125 | 6 | 45 | 18,11 |
| 059125010115 | 125 | 12 | 45 | 18,11 |
| 059140010115 | 140 | 12 | 39 | 22,89 |
| 059140010116 | 140 | 6 | 39 | 22,89 |
| 059160010115 | 160 | 12 | 28 | 24,10 |
| 059160010116 | 160 | 6 | 28 | 24,10 |
| 059180010115 | 180 | 12 | 22 | 36,33 |
| 059200010115 | 200 | 12 | 6 | 46,94 |
| 059200010116 | 200 | 6 | 6 | 46,94 |
| 059250010115 | 250 | 12 | 5 | 83,25 |
| 059250010116 | 250 | 6 | 5 | 83,25 |
| 059315010113 | 315 | 13 | 4 | 105,20 |
| 059315010116 | 315 | 6 | 4 | 105,20 |
| 059355010113 | 355 | 13 | 3 | 142,02 |
| 059400010113 | 400 | 13 | 3 | 149,02 |
| 059500010113 | 500 | 13 | 2 | 231,59 |
| 059630010113 | 630 | 13 | 2 | 365,73 |
| 059710010113 | 710 | 13 | 2 | 464,81 |

PN10 / SDR 17 Rollos

| Ref. | Ø Ext. | Long. | Barras /Palet | €/m |
|--------------|--------|-------|---------------|-------|
| 059032010125 | 32 | 100 | - | 1,10 |
| 059040010125 | 40 | 100 | - | 1,81 |
| 059050010125 | 50 | 100 | - | 2,70 |
| 059063010125 | 63 | 100 | - | 4,11 |
| 059075010124 | 75 | 50 | - | 7,23 |
| 059075010125 | 75 | 100 | - | 7,23 |
| 059090010125 | 90 | 100 | - | 9,43 |
| 059090010124 | 90 | 50 | - | 9,43 |
| 059110010124 | 110 | 50 | - | 13,87 |
| 059110010125 | 110 | 100 | - | 13,87 |

PN16 / SDR 11 Barras

| Ref. | Ø Ext. | Long. | Barras /Palet | €/m |
|--------------|--------|-------|---------------|--------|
| 060040016116 | 40 | 6 | 100 | 2,64 |
| 060050016116 | 50 | 6 | 80 | 3,98 |
| 060063016116 | 63 | 6 | 131 | 6,01 |
| 060075016116 | 75 | 6 | 100 | 8,22 |
| 060090016116 | 90 | 6 | 63 | 11,63 |
| 060110016116 | 110 | 6 | 43 | 17,12 |
| 060110016115 | 110 | 12 | 43 | 17,12 |
| 060125016115 | 125 | 12 | 30 | 21,95 |
| 060125016116 | 125 | 6 | 30 | 21,95 |
| 060160016116 | 160 | 6 | 17 | 35,62 |
| 060160016115 | 160 | 12 | 17 | 35,62 |
| 060200016116 | 200 | 6 | 6 | 55,31 |
| 060200016115 | 200 | 12 | 6 | 55,31 |
| 060225016116 | 225 | 6 | 5 | 69,57 |
| 060250016115 | 250 | 12 | 5 | 85,80 |
| 060250016116 | 250 | 6 | 5 | 85,80 |
| 060315016113 | 315 | 13 | 4 | 136,50 |
| 060315016116 | 315 | 6 | 4 | 136,50 |
| 060400016113 | 400 | 13 | 3 | 220,10 |

PN16 / SDR 11 Rollos

| Ref. | Ø Ext. | Long. | Barras /Palet | €/m |
|--------------|--------|-------|---------------|-------|
| 060020016125 | 20 | 100 | - | 0,83 |
| 060025016125 | 25 | 100 | - | 1,01 |
| 060032016125 | 32 | 100 | - | 1,59 |
| 060040016125 | 40 | 100 | - | 2,64 |
| 060050016125 | 50 | 100 | - | 3,98 |
| 060063016125 | 63 | 100 | - | 6,01 |
| 060075016125 | 75 | 100 | - | 8,22 |
| 060075016124 | 75 | 50 | - | 8,22 |
| 060090016125 | 90 | 100 | - | 11,63 |
| 060090016124 | 90 | 50 | - | 11,63 |
| 060110016125 | 110 | 100 | - | 17,12 |
| 060110016124 | 110 | 50 | - | 17,12 |

FLEXIPOL - MASA
TUBOS DE POLIETILENO PE100

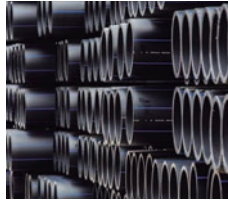

* Para Otros formatos, bandas presiones y aplicaciones se establece una cantidad mínima por pedido.

| Ø Medida | Cantidad mínima |
|----------|-----------------|
| | por pedido (m) |
| 20 | 20000 |
| 25 | 15000 |
| 32 | 10000 |
| 40 | 5000 |
| 50 | 4000 |
| 63 | 2500 |
| 75 | 1500 |
| 90 | 1000 |
| 110 | 1000 |
| 125 | 800 |
| 140 | 500 |
| 160 | 600 |
| 180 | 500 |
| 200 | 400 |
| 225 | 450 |
| 250 | 400 |
| 280 | 450 |
| 315 | 200 |
| 355 | 200 |
| 400 | 150 |
| 450 | 200 |
| 500 | 150 |
| 560 | 200 |
| 630 | 150 |
| 710 | 150 |
| 800 | 100 |
| 900 | 100 |
| 1000 | 100 |

| Ø Medida | C X PALET AGUA | |
|----------|----------------|-------------|
| | PN 10 | PN 16 |
| 20 | | 250 (metro) |
| 25 | | 200 (metro) |
| 32 | 150 (metro) | 150 (metro) |
| 40 | 100 (barra) | 100 (barra) |
| 50 | 80 (barra) | 80 (barra) |
| 63 | 131 (barra) | 131 (barra) |
| 75 | 100 (barra) | 100 (barra) |
| 90 | 63 (barra) | 63 (barra) |
| 110 | 60 (barra) | 43 (barra) |
| 125 | 45 (barra) | 30 (barra) |
| 140 | 39 (barra) | 26 (barra) |
| 160 | 28 (barra) | 17 (barra) |
| 180 | 22 (barra) | 17 (barra) |
| 200 | 6 (barra) | 6 (barra) |
| 225 | 5 (barra) | 5 (barra) |
| 250 | 5 (barra) | 5 (barra) |
| 280 | 4 (barra) | 4 (barra) |
| 315 | 4 (barra) | 4 (barra) |
| 355 | 3 (barra) | 3 (barra) |
| 400 | 3 (barra) | 3 (barra) |
| 450 | 2 (barra) | 2 (barra) |
| 500 | 2 (barra) | 2 (barra) |
| 560 | 2 (barra) | 2 (barra) |
| 630 | 2 (barra) | 2 (barra) |
| 710 | 2 (barra) | |
| 800 | 2 (barra) | |
| 900 | 1 (barra) | |
| 1000 | 1 (barra) | |

FLEXIPOL - MASA
TUBOS DE POLIETILENO FM

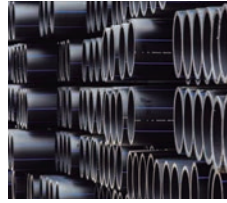

Declaración de cumplimiento Hessel con la PAS 1075 disponible.

| Nº Material antiguo | SDR | Medida | Texto breve de material | Importe | UM |
|---------------------|-------|--------|------------------------------------|---------|----|
| A1G0630121F0 | SDR9 | 63 | TUBO D 63 FM1613 SDR9 BARRAS 12M | 16,75 | M |
| A1G0750121F0 | SDR9 | 75 | TUBO D 75 FM1613 SDR9 BARRAS 12M | 19,20 | M |
| A1G0900121F0 | SDR9 | 90 | TUBO D90 FM1613 SDR9 BARRAS 12M | 22,84 | M |
| A1G1100121F0 | SDR9 | 110 | TUBO D110 FM1613 SDR9 BARRAS 12M | 33,87 | M |
| A1G1250121F0 | SDR9 | 125 | TUBO D125 FM1613 SDR9 BARRAS 12M | 57,41 | M |
| A1G1400121F0 | SDR9 | 140 | TUBO D140 FM1613 SDR9 BARRAS 12M | 64,31 | M |
| A1G1600121F0 | SDR9 | 160 | TUBO D160 FM1613 SDR9 BARRAS 12M | 71,86 | M |
| A1G1800121F0 | SDR9 | 180 | TUBO D180 FM1613 SDR9 BARRAS 12M | 94,45 | M |
| A1G2000121F0 | SDR9 | 200 | TUBO D200 FM1613 SDR9 BARRAS 12M | 112,02 | M |
| A1G2250121F0 | SDR9 | 225 | TUBO D225 FM1613 SDR9 BARRAS 12M | 138,67 | M |
| A1G2501181F0 | SDR9 | 250 | TUBO D250 FM1613 SDR9 BARRAS 11,8M | 188,21 | M |
| A1G2500121F0 | SDR9 | 250 | TUBO D250 FM1613 SDR9 BARRAS 12M | 174,38 | M |
| A1G2800121F0 | SDR9 | 280 | TUBO D280 FM1613 SDR9 BARRAS 12M | 215,22 | M |
| A1G3150121F0 | SDR9 | 315 | TUBO D315 FM1613 SDR9 BARRAS 12M | 271,61 | M |
| A1F0630121F0 | SDR11 | 63 | TUBO D 63 FM1613 SDR11 BARRAS 12M | 11,91 | M |
| A1F0750121F0 | SDR11 | 75 | TUBO D 75 FM1613 SDR11 BARRAS 12M | 15,52 | M |
| A1F0900121F0 | SDR11 | 90 | TUBO D90 FM1613 SDR11 BARRAS 12M | 19,03 | M |
| A1F1100121F0 | SDR11 | 110 | TUBO D110 FM1613 SDR11 BARRAS 12M | 28,22 | M |
| A1F1250121F0 | SDR11 | 125 | TUBO D125 FM1613 SDR11 BARRAS 12M | 41,88 | M |
| A1F1400121F0 | SDR11 | 140 | TUBO D140 FM1613 SDR11 BARRAS 12M | 53,53 | M |
| A1F1600121F0 | SDR11 | 160 | TUBO D160 FM1613 SDR11 BARRAS 12M | 59,88 | M |
| A1F1800121F0 | SDR11 | 180 | TUBO D180 FM1613 SDR11 BARRAS 12M | 79,37 | M |
| A1F2000121F0 | SDR11 | 200 | TUBO D200 FM1613 SDR11 BARRAS 12M | 93,36 | M |
| A1F2250121F0 | SDR11 | 225 | TUBO D225 FM1613 SDR11 BARRAS 12M | 115,56 | M |
| A1F2500121F0 | SDR11 | 250 | TUBO D250 FM1613 SDR11 BARRAS 12M | 145,32 | M |
| A1F2800121F0 | SDR11 | 280 | TUBO D280 FM1613 SDR11 BARRAS 12M | 179,35 | M |
| A1F3150121F0 | SDR11 | 315 | TUBO D315 FM1613 SDR11 BARRAS 12M | 226,34 | M |
| A1F3550121F0 | SDR11 | 355 | TUBO D355 FM1613 SDR11 BARRAS 12M | 285,23 | M |
| A1F4000121F0 | SDR11 | 400 | TUBO D400 FM1613 SDR11 BARRAS 12M | 359,98 | M |
| A1F4500121F0 | SDR11 | 450 | TUBO D450 FM1613 SDR11 BARRAS 12M | 454,93 | M |
| A1F5000121F0 | SDR11 | 500 | TUBO D500 FM1613 SDR11 BARRAS 12M | 562,60 | M |
| A1F5600121F0 | SDR11 | 560 | TUBO D560 FM1613 SDR11 BARRAS 12M | 699,05 | M |
| A1F6300121F0 | SDR11 | 630 | TUBO D630 FM1613 SDR11 BARRAS 12M | 898,71 | M |

FLEXIPOL - MASA - TUBOS DE POLIETILENO PE100 RD

Tubo confeccionado con resina RD de última generación aditivada que le confiere una mayor resistencia a la desinfección realizada en las tuberías de agua potable incluso utilizando Dioxido de Cloro.

Reduce los costes de mantenimiento por ataques químicos. La resina PE-100 RD confiere a la tubería una seguridad 3.5 veces mayor que otras resinas (PEX-b HP, PVC, PE-100 Estándar).

Tubo óptimo para acometidas, donde la influencia de las temperaturas y desinfección afecta más a las instalaciones, y donde el PH del agua es elevado (plantas desaladoras).

Diámetros y espesores conforme a la norma UNE EN-12201 y NF-114 (Francia).



Amplio abanico de certificados disponibles:

ACS de materia prima.
Materia prima certificada por AENOR bajo la UNE EN-12201.
Materia prima homologada por LNE (NF-114) Francia.
Materia prima Certificada por IIP (Istituto Italiano del Plástico) Italia.
Materia prima Certificada por HY (Hygiene-Institut des Ruhrgebiets) Alemania.

FLEXIPOL - TUBOS DE POLIETILENO PE100 RC

Tubo confeccionado con resina RC de última generación que le confiere una mayor resistencia a la propagación lenta y rápida de fisuras y a las cargas puntuales

Cumple con los estrictos requisitos de propagación lenta de fisuras de acuerdo a PAS 1075. Declaración de cumplimiento Hessel disponible.

Ventajas respecto a grados PE 100 Estándar: Ahorro en costes de obra civil

El tubo puede ser instalado sin lecho de arena
En función del tipo de árido de la excavación éste puede ser reutilizado

Mejor comportamiento en instalaciones "agresivas".

En instalaciones en terrenos con rocas, piedras etc es importante si el tubo sufre arañazos en la instalación.
Es recomendable para nuevas técnicas de entubado sin zanja: Perforación dirigida, bursting, relining... Donde el tubo sufre abrasión directa

Propiedades Físicas:

Alta resistencia a la propagación lenta de fisuras.

Supera los requisitos estándar del Notched Pipe Test (NPT) según ISO 13479:
Para UNE-EN-1555 > 500h
Para la Asociación PE 100 Plus > 500h
La resina utilizada por MASA > 9.500 h, es decir, superior al año
Supera los requisitos del Full Notch Creep Test (FNCT) Test según ISO 16770:

Para DIBt > 300 h
Para DVGW GW 323 > 3.300 h
La resina utilizada por MASA > 8.760 h, es decir, superior al año

Alta resistencia a la propagación rápida de fisuras.

La resistencia a la propagación rápida de fisuras puede ser medida mediante el Test S4 de acuerdo a la ISO 13477.
La resina utilizada por MASA tiene una alta resistencia en comparación con los requisitos de Ref.:
Para UNE-EN-1555 > 10bar a 0° C
La resina utilizada por MASA alcanza resultados de > 20 bar a -15° C

Amplio abanico de certificados disponibles:

ACS de materia prima y tubo
Materia prima y tubo certificado por AENOR bajo la UNE-EN-12201 y UNE-EN-1555
Test S4 con diferentes parámetros
Notch Pipe Test > 10.500 h
Point Loading Test > 1 Año
DVGW W270
ISO 9080
Compatibilidad de soldadura
Envejecimiento por calor Hessel: Ensayo superado con 2 Mpa
Resistencia al gas condensado

FLEXIPOL - TUBOS DE POLIETILENO PE100 RT

Tubo fabricado con un polietileno de alta densidad (PE100) negro, que combina las tradicionales cualidades de los tubos de polietileno con nuevas propiedades que amplían sus posibilidades y campo de utilización.

- Resistencia química
- Resistencia a la abrasión.
- Buenas propiedades organolépticas (para su uso con agua potable)
- Buena resistencia a la fluencia
- Posibilidad de unión por termofusión.
- Resistencia a la oxidación
- Buena resistencia a la intemperie

- Alta estabilidad dimensional
- Excelentes propiedades de resistencia al agrietamiento por tensión (ESCR)
- Muy buena resistencia hidrostática a largo plazo, incluso a temperaturas elevadas.
- Excelente envejecimiento al calor
- Alta estabilidad frente a la extracción.

Estas propiedades permiten que este tipo de tubos sean utilizados en nuevas aplicaciones, como son el transporte de agua caliente (a temperaturas superiores a los 40°C admitidos para los tubos PE100), unidades de desalinización ó conductos para cables de potencia.

TUBOS FLEXIPOL PE100 RANURADOS O PERFORADOS PARA EL DRENAJE DE LIXIVIADOS Y CAPTACIÓN DE BIOGÁS

Tubos manipulados a partir de tubos estándar de PE100 según UNE-EN-12201

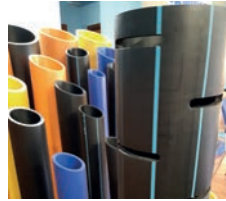

TUBO RANURADO A 1/3 , 2/3 O COMPLETO DE ACUERDO A DIN 4266 Y 4262

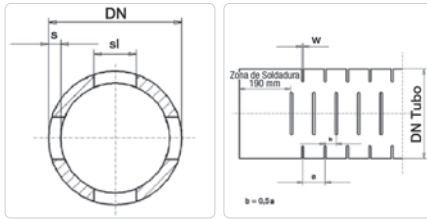

TUBO PERFORADO

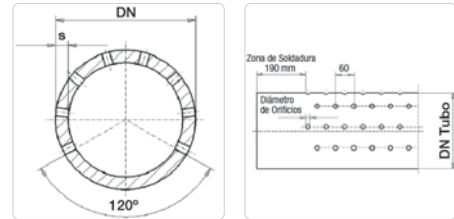

Para medidas solicitar fichas técnicas

TIPOS DE RANURADO

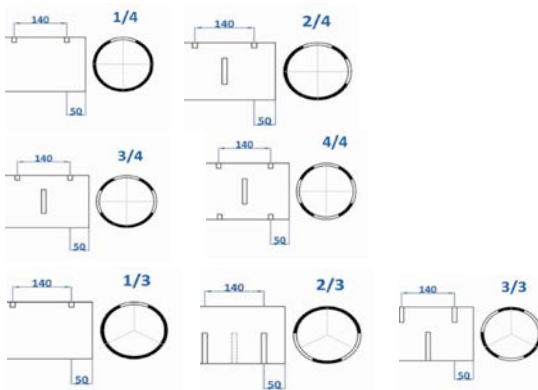

TIPOS DE PERFORACIÓN

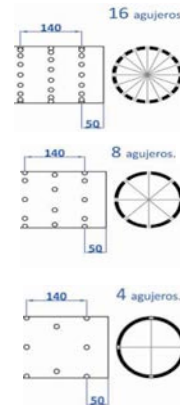

| Ø Ext. | PN6 | PN10 | PN16 |
|--------|-----|-----------|------|
| 63 | | | |
| 75 | | | |
| 90 | | | |
| 110 | | | |
| 125 | | | |
| 140 | | | |
| 160 | | | |
| 180 | | Consultar | |
| 200 | | | |
| 225 | | | |
| 250 | | | |
| 280 | | | |
| 315 | | | |
| 355 | | | |
| 400 | | | |

| Ø Ext. | PN6 | PN10 | PN16 |
|--------|-----|-----------|------|
| 63 | | | |
| 75 | | | |
| 90 | | | |
| 110 | | | |
| 125 | | | |
| 140 | | | |
| 160 | | | |
| 180 | | Consultar | |
| 200 | | | |
| 225 | | | |
| 250 | | | |
| 280 | | | |
| 315 | | | |
| 355 | | | |
| 400 | | | |

Escoger tipo de ranurado, diámetro del tubo y presión. Ancho ranura 12 mm.

Escoger tipo de perforación, diámetro del tubo y presión. Ø agujero 12 mm

EXCEL-PLUS®

Tubo multicapa para acometidas de agua potable fabricado con PE100 RC y revestimiento interior de PVDF Kynar®. Certificado Sanitario ACS del laboratorio CARSO Laboratoire Santé Environnement Hygiène de Lyon (Francia). Óptimo comportamiento en lugares de desinfección concentrada y alta temperatura.



Resistencia mecánica

El cuerpo en PE100 RC PN16 conforme a norma UNE-EN-12201 dota al tubo de una mayor resistencia mecánica al punzonamiento y a la propagación rápida y lenta de las fisuras. Gran resistencia a los terrenos corrosivos y a la corrosión electrolytica generada por el transporte en ambientes eléctricos.

Insensibilidad a los desinfectantes

El revestimiento interno de PVDF confiere una protección duradera a la oxidación generada por los desinfectantes. Se trata de un polímero caracterizado por una gran resistencia química a los oxidantes en fuerte concentración y temperatura elevada.

Impermeable a hidrocarburos

Sometido al ensayo (WIS 4-32-19) impuesto a los tubos con barrera de aluminio el tubo Excel Plus® demostró su impermeabilidad a los hidrocarburos presentando idénticas prestaciones que estos multicapas tricapa pero con una mayor facilidad de puesta en obra.

Inhibición de biofilm

El revestimiento interno de PVDF Kynar® ralentiza considerablemente la proliferación bacteriana en las paredes del tubo en comparación con un tubo estándar de PE, o un acero, y facilita la eliminación de ese biofilm.

Instalación con accesorios estándar para PE.

Recomendable realizar la unión con accesorios electrosoldables de alta seguridad FRIALEN®

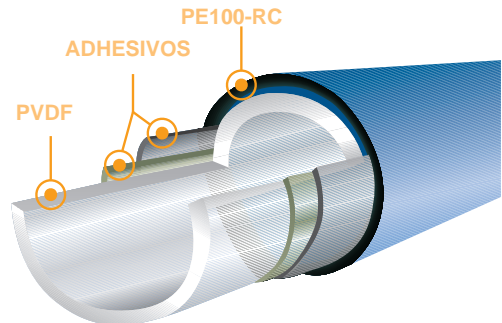

| Ø Exterior (mm) | Espesor min. (mm) | Peso (kg/m) | Diámetro rollo 50m (m) | Ancho de rollo (m) | Peso aprox. rollo 50m (kg) | Peso aprox. barra 5m (kg) |
|-----------------|-------------------|-------------|------------------------|--------------------|----------------------------|---------------------------|
| 25 | 2,3 | 0,195 | 1,20 | 0,200 | 10,00 | 0,98 |
| 32 | 3,0 | 0,310 | 1,40 | 0,200 | 16,00 | 1,55 |
| 40 | 3,7 | 0,469 | 1,40 | 0,300 | 24,00 | 2,35 |
| 50 | 4,6 | 0,715 | 1,70 | 0,160 | 36,00 | 3,58 |
| 63 | 5,8 | 1,114 | 1,70 | 0,260 | 56,00 | 5,57 |
| 75 | 6,8 | 1,542 | 2,15 | 0,225 | 77,11 | 7,71 |
| 90 | 8,2 | 2,215 | 2,50 | 0,370 | 110,77 | 11,08 |
| 110 | 10,0 | 3,262 | - | - | - | 16,31 |



EXCEL-PLUS®

| Ref. | Formato | Ø Ext. | Espesor | €/m |
|--------------|---------------|--------|---------|-------|
| X5F0250051M0 | Barras 5 mts | 25 | 2,30 | 10,44 |
| X5F0250502M0 | Rollos 50 mts | 25 | 2,30 | 10,44 |
| X5F0320051M0 | Barras 5 mts | 32 | 3,00 | 13,89 |
| X5F0320502M0 | Rollos 50 mts | 32 | 3,00 | 13,89 |
| X5F0400051M0 | Barras 5 mts | 40 | 3,70 | 19,48 |
| X5F0400502M0 | Rollos 50 mts | 40 | 3,70 | 19,48 |
| X5F0500051M0 | Barras 5 mts | 50 | 4,60 | 22,86 |
| X5F0500502M0 | Rollos 50 mts | 50 | 4,60 | 22,86 |
| X5F0630051M0 | Barras 5 mts | 63 | 5,80 | 30,74 |
| X5F0630502M0 | Rollos 50 mts | 63 | 5,80 | 30,74 |
| X5F0750501M0 | Barras 5 mts | 75 | 6,80 | 41,14 |
| X5F0750502M0 | Rollos 50 mts | 75 | 6,80 | 43,18 |
| X5F0900501M0 | Barras 5 mts | 90 | 8,20 | 51,00 |
| X5F0900502M0 | Rollos 50 mts | 90 | 8,20 | 56,07 |
| X5F1100501M0 | Barras 5 mts | 110 | 10,00 | 65,97 |

| DN | Formato Rollos | Formato Barras |
|----------|-------------------------------------|------------------------------------|
| 25 | Paquetes de 8 rollos (400 metros) | Paquetes de 25 barras (125 metros) |
| 32 | Paquetes de 7 rollos (350 metros) | Paquetes de 25 barras (125 metros) |
| 40 | Paquetes de 3 rollos (150 metros) | Paquetes de 20 barras (100 metros) |
| 50 | Paquetes de 3 rollos (150 metros) | Paquetes de 16 barras (80 metros) |
| 63 | Paquetes de 3 rollos (150 metros) | Paquetes de 16 barras (80 metros) |
| 75 a 110 | consultar disponibilidad | consultar disponibilidad |



SISTEMA DE ACOMETIDA

| Set de Acometida | €/ud (Con 1 m de tubo) | €/ud (Con 2 m de tubo) |
|---|------------------------|------------------------|
| Set de Acometida DN 25* Toma en carga DAA 63/32 Reducción MR 32/25 Válvula de Bola KH DN 25 Manguito UB DN 25 Tubo Excel Plus DN25 | 131,80 | 143,96 |
| Set de Acometida DN 32* Toma en carga DAA 63/32 Manguito UB DN 32 Válvula de Bola KH DN 32 Manguito UB DN 32 Tubo Excel Plus DN32 | 141,41 | 157,56 |

* Consultar precios para otras medidas y/o longitudes de tubo mayores a 1 y 2 m
 Los sets se suministran sin soldar. Posibilidad de suministro con soldaduras bajo petición.

**GASYPOL - MASA
TUBOS DE POLIETILENO
PE100 RC**

Resistente a la propagación rápida y lenta de fisuras y cargas puntuales

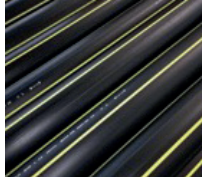

Para Conducción de Combustibles Gaseosos. Fabricados según Norma UNE-EN 1555.
Declaración de cumplimiento Hessel con la PAS 1075 disponible.

COLORES: negro banda amarilla.

MARCAJE*: MASA GASYPOL
**Personalizados bajo petición*

FORMATO DE SUMINISTROS*

Hasta Ø63 en rollos de 100 metros
Ø90 y Ø110 (SDR 11) rollos de 50 metros
Desde Ø110 barras de 8 y 12 metros

**Para otras medidas y SDR consultar la cantidad mínima por pedido en la página 9.*

SDR 11

| Ø Ext. | Espesor | €/m |
|--------|---------|--------|
| 20 | 3,0 | 1,71 |
| 25 | 3,0 | 2,22 |
| 32 | 3,0 | 2,57 |
| 40 | 3,7 | 3,84 |
| 63 | 5,8 | 8,69 |
| 90 | 8,2 | 17,57 |
| 110 | 10,0 | 26,06 |
| 160 | 14,6 | 55,27 |
| 200 | 18,2 | 86,17 |
| 250 | 22,7 | 134,14 |

SDR 17

| Ø Ext. | Espesor | €/m |
|--------|---------|--------|
| 63 | 3,8 | 5,93 |
| 90 | 5,4 | 12,03 |
| 110 | 6,6 | 17,90 |
| 160 | 9,5 | 37,40 |
| 200 | 11,9 | 58,39 |
| 250 | 14,8 | 90,76 |
| 315 | 18,7 | 144,41 |

MONOTUBO POLIETILENO

COLORES

Negro
Personalizados bajo consulta

FORMATO DE SUMINISTROS

Personalizados: rollos y/o bobinas

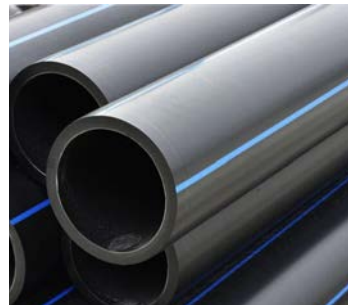

| Ref. | Ø | €/m |
|--------|----|------|
| 011032 | 32 | 3,20 |
| 010040 | 40 | 4,80 |
| 011040 | 40 | 5,60 |
| 012040 | 40 | 5,91 |
| 010050 | 50 | 4,80 |
| 011050 | 50 | 6,39 |
| 011063 | 63 | 6,08 |



Proveedor global de soluciones en agua y energía

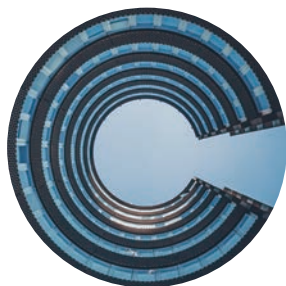

Edificación



Infraestructura



Industria



Agricultura

Trabaja con nuestro equipo de ingenieros y expertos en conducción de fluidos de todo el mundo. Te acompañarán de principio a fin en todos tus proyectos.



0137

Magnum 3G

Sistema para unión de tuberías a presión Magnum 3G

Fitting para tubo de PE

Fitting con inserto de latón

Fitting UTC/PE

Fitting alta resistencia química HCR

Válvulas para contador HCR

Repuestos



Sistema para unión de tuberías a presión

INFRAESTRUCTURA



Más información





Sistema para unión de tuberías a presión Magnum 3G

Fitting para tubo de PE



- **Gama de accesorios de compresión para tuberías de Polietileno** desde 16 hasta 110 mm de diámetro con sistema desliza y aprieta y montaje en sólo 2 pasos.
- **Apto para agua potable y adecuado para el transporte de fluidos a presión** en industria, infraestructura, edificación y agricultura con una fiabilidad total. 1.600Kpa (PN16) a 20oC.
- **Certificaciones de Ø16 a Ø63: KIWA - ACS- AENOR - IIP - DVGW**

kiwa



AENOR
Asociación Española de
Normalización y Certificación



J-63



| Medida | Ref. | U/ | / n.º | € |
|--------|--------|-----|-------|--------|
| 16 | M55149 | 50 | A-1 | 3,15 |
| 20 | M55017 | 100 | A-11 | 3,91 |
| 25 | M55018 | 100 | A-11 | 4,74 |
| 32 | M55019 | 100 | A-11 | 6,75 |
| 40 | M55020 | 100 | A-9 | 10,57 |
| 50 | M55003 | 100 | A-9 | 15,27 |
| 63 | M55004 | 100 | A-9 | 23,02 |
| 75 | M55021 | 100 | A-11 | 50,75 |
| 90 | M55022 | 100 | A-9 | 65,96 |
| 110 | M55165 | 2 | A-8 | 102,45 |

Enlace recto.

J-68



| Medida | Ref. | U/ | / n.º | € |
|--------|--------|----|-------|-------|
| 20-16 | M55153 | 50 | A-2 | 3,92 |
| 25-16 | M55229 | 50 | A-2 | 4,74 |
| 25-20 | M55041 | 50 | A-2 | 4,74 |
| 32-20 | M55374 | 25 | A-2 | 7,10 |
| 32-25 | M55042 | 25 | A-2 | 6,75 |
| 40-25 | M55375 | 25 | A-11 | 13,10 |
| 40-32 | M55043 | 25 | A-11 | 10,74 |
| 50-25 | M55376 | 15 | A-11 | 17,97 |
| 50-32 | M55377 | 15 | A-11 | 17,97 |
| 50-40 | M55044 | 15 | A-11 | 20,70 |
| 63-32 | M55378 | 15 | A-9 | 21,86 |
| 63-40 | M55379 | 15 | A-9 | 21,86 |
| 63-50 | M55045 | 15 | A-9 | 28,38 |
| 75-63 | M55070 | 5 | A-11 | 50,62 |
| 90-75 | M55071 | 5 | A-9 | 68,58 |
| 110-90 | M55221 | 2 | A-8 | 99,31 |

Enlace reducido.

J-95



| Medida | Ref. | U/ | / n.º | € |
|--------|--------|-----|-------|-------|
| 20 | M55330 | 100 | A-11 | 14,90 |
| 25 | M55331 | 100 | A-9 | 6,95 |
| 32 | M55332 | 50 | A-9 | 8,12 |
| 40 | M55333 | 50 | A-12 | 15,10 |
| 50 | M55334 | 25 | A-4 | 14,82 |
| 63 | M55335 | 20 | A-12 | 27,49 |

Enlace recto para reparaciones.

J-97



| Medida | Ref. | U/ | / n.º | € |
|--------|--------|----|-------|-------|
| 32 | M55394 | 50 | A-9 | 10,62 |
| 40 | M55395 | 25 | A-8 | 15,06 |
| 50 | M55396 | 15 | A-9 | 20,55 |
| 63 | M55397 | 15 | A-12 | 27,22 |

Enlace acodado 45°.



J-64

| Medida | Ref. | U/ | / n.º | € |
|--------|--------|----|-------|--------|
| 16 | M55154 | 50 | A-1 | 3,15 |
| 20 | M55029 | 50 | A-2 | 3,91 |
| 25 | M55030 | 50 | A-11 | 4,74 |
| 32 | M55031 | 50 | A-9 | 6,98 |
| 40 | M55032 | 25 | A-8 | 10,57 |
| 50 | M55009 | 15 | A-9 | 15,27 |
| 63 | M55010 | 15 | A-12 | 22,98 |
| 75 | M55033 | 5 | A-9 | 58,69 |
| 90 | M55034 | 5 | A-4 | 68,04 |
| 110 | M55190 | 2 | A-9 | 160,66 |

Enlace acodado 90°.



J-69

| Medida | Ref. | U/ | / n.º | € |
|---------|--------|----|-------|-------|
| 16-½" | M55312 | 50 | A-2 | 4,04 |
| 20-½" | M55096 | 50 | A-2 | 3,93 |
| 20-¾" | M55313 | 50 | A-2 | 3,87 |
| 25-½" | M55217 | 50 | A-2 | 4,86 |
| 25-¾" | M55097 | 50 | A-2 | 4,86 |
| 25-1" | M55314 | 50 | A-2 | 4,75 |
| 32-¾" | M55315 | 25 | A-2 | 5,97 |
| 32-1" | M55098 | 25 | A-2 | 6,12 |
| 32-1 ¼" | M55316 | 25 | A-2 | 6,12 |
| 40-1" | M55317 | 25 | A-11 | 7,72 |
| 40-1 ¼" | M55099 | 25 | A-11 | 7,98 |
| 50-1 ¼" | M55318 | 20 | A-9 | 10,67 |
| 50-1 ½" | M55163 | 20 | A-9 | 10,88 |
| 50-2" | M55164 | 20 | A-4 | 16,59 |

Enlace acodado 90° rosca macho.



J-59

| Medida | Ref. | U/ | / n.º | € |
|--------|--------|----|-------|-------|
| 63 | M55735 | 10 | A-4 | 34,00 |

Te 45°.



J-71

SIN REFUERZO METÁLICO

| Medida | Ref. | U/ | / n.º | € |
|---------|--------|----|-------|-------|
| 16-½" | M55393 | 50 | A-2 | 3,60 |
| 20-½" | M55135 | 50 | A-2 | 5,09 |
| 20-¾" | M55307 | 50 | A-2 | 5,00 |
| 25-½" | M55218 | 50 | A-2 | 5,94 |
| 25-¾" | M55136 | 50 | A-2 | 5,91 |
| 25-1" | M55308 | 50 | A-2 | 5,80 |
| 32-¾" | M55242 | 25 | A-2 | 7,38 |
| 32-1" | M55137 | 25 | A-2 | 7,38 |
| 32-1 ¼" | M55309 | 25 | A-2 | 8,52 |
| 40-1" | M55310 | 25 | A-11 | 11,89 |
| 40-1 ¼" | M55138 | 25 | A-11 | 9,22 |
| 50-1 ¼" | M55311 | 20 | A-9 | 13,50 |
| 50-1 ½" | M55159 | 20 | A-9 | 13,77 |
| 50-2" | M55364 | 20 | A-9 | 14,73 |
| 63-2" | M55160 | 20 | A-4 | 16,90 |



J-71

CON REFUERZO METÁLICO

| Medida | Ref. | U/ | / n.º | € |
|---------|--------|----|-------|--------|
| 20-½" | M55175 | 50 | A-2 | 5,66 |
| 20-¾" | M55366 | 50 | A-2 | 6,97 |
| 25-½" | M55225 | 50 | A-2 | 6,41 |
| 25-¾" | M55176 | 50 | A-2 | 6,63 |
| 25-1" | M55367 | 50 | A-2 | 6,97 |
| 32-¾" | M55243 | 25 | A-2 | 8,19 |
| 32-1" | M55177 | 25 | A-2 | 8,19 |
| 32-1 ¼" | M55368 | 25 | A-2 | 9,00 |
| 40-1" | M55369 | 25 | A-11 | 12,36 |
| 40-1 ¼" | M55178 | 25 | A-11 | 12,36 |
| 50-1 ¼" | M55370 | 20 | A-9 | 13,96 |
| 50-1 ½" | M55188 | 20 | A-9 | 15,76 |
| 50-2" | M55371 | 20 | A-9 | 15,19 |
| 63-2" | M55189 | 20 | A-4 | 19,45 |
| 75-2 ½" | M55257 | 10 | A-9 | 35,66 |
| 90-3" | M55258 | 6 | A-9 | 48,20 |
| 110-4" | M55259 | 4 | A-4 | 108,61 |

Enlace acodado 90° rosca hembra..



J-73

| Medida | Ref. | U/ | / n.º | € |
|--------|--------|-----|-------|--------|
| 16 | M55150 | 50 | A-2 | 4,99 |
| 20 | M55072 | 100 | A-9 | 5,94 |
| 25 | M55073 | 100 | A-4 | 7,15 |
| 32 | M55074 | 25 | A-8 | 10,13 |
| 40 | M55075 | 25 | A-4 | 15,81 |
| 50 | M55086 | 10 | A-9 | 23,06 |
| 63 | M55087 | 10 | A-4 | 34,69 |
| 75 | M55088 | 5 | A-4 | 86,41 |
| 90 | M55089 | 5 | A-4 | 107,68 |
| 110 | M55191 | 2 | A-4 | 184,22 |

Te bocas iguales.



J-74

| Medida | Ref. | U/ | / n.º | € |
|--------|--------|----|-------|-------|
| 25-20 | M55115 | 50 | A-8 | 11,29 |
| 25-32 | M55380 | 50 | A-8 | 10,13 |
| 32-25 | M55116 | 25 | A-8 | 13,15 |
| 40-25 | M55381 | 25 | A-9 | 15,49 |
| 40-32 | M55117 | 25 | A-9 | 15,81 |
| 50-25 | M55382 | 10 | A-9 | 24,29 |
| 50-32 | M55383 | 10 | A-9 | 24,29 |
| 50-40 | M55118 | 10 | A-9 | 24,29 |
| 63-25 | M55384 | 10 | A-4 | 28,35 |
| 63-32 | M55385 | 10 | A-4 | 32,72 |
| 63-50 | M55119 | 10 | A-4 | 34,54 |

Te 90º reducida al centro



J-96

| Medida | Ref. | U/ | / n.º | € |
|--------|--------|-----|-------|-------|
| 20 | M55387 | 100 | A-9 | 8,62 |
| 25 | M55388 | 100 | A-4 | 11,07 |
| 32 | M55389 | 25 | A-8 | 14,74 |
| 40 | M55390 | 25 | A-4 | 23,96 |
| 50 | M55391 | 10 | A-9 | 32,88 |
| 63 | M55392 | 10 | A-4 | 44,42 |

Te 90º para reparaciones.



J-66

| Medida | Ref. | U/ | / n.º | € |
|-----------|--------|----|-------|--------|
| 40-40 | M55365 | 10 | A-11 | 24,87 |
| 50-40 | M55100 | 10 | A-11 | 24,87 |
| 50-50 | M55373 | 10 | A-11 | 27,27 |
| 63-50 | M55101 | 10 | A-9 | 35,21 |
| 75-2 1/2" | M55102 | 5 | A-8 | 40,71 |
| 90-3" | M55103 | 5 | A-9 | 63,11 |
| 110-4" | M55222 | 2 | A-11 | 118,31 |

Enlace brida.



J-60

| Medida | Ref. | U/ | / n.º | € |
|-----------|--------|----|-------|-------|
| 25-1/2" | M55353 | 50 | A-11 | 7,24 |
| 25-3/4" | M55195 | 50 | A-11 | 7,38 |
| 32-1" | M55196 | 25 | A-11 | 10,10 |
| 40-1 1/4" | M55304 | 50 | A-5 | 18,52 |
| 50-1 1/2" | M55305 | 15 | A-9 | 23,04 |
| 63-2" | M55306 | 15 | A-4 | 43,34 |

Te 90º rosca macho.



SIN REFUERZO METÁLICO

J-65

| Medida | Ref. | U/ | / n.º | € |
|---------|--------|-----|-------|-------|
| 16-½" | M55354 | 100 | A-8 | 4,38 |
| 20-½" | M55023 | 100 | A-8 | 4,99 |
| 20-¾" | M55324 | 100 | A-8 | 6,89 |
| 25-½" | M55219 | 50 | A-11 | 7,04 |
| 25-¾" | M55024 | 100 | A-9 | 7,04 |
| 25-1" | M55325 | 100 | A-8 | 7,43 |
| 32-¾" | M55244 | 50 | A-9 | 9,64 |
| 32-1" | M55025 | 50 | A-9 | 9,64 |
| 32-1 ¼" | M55326 | 50 | A-8 | 10,89 |
| 40-1" | M55328 | 50 | A-12 | 15,24 |
| 40-1 ¼" | M55026 | 50 | A-12 | 15,24 |
| 50-1 ¼" | M55329 | 15 | A-9 | 17,13 |
| 50-1 ½" | M55007 | 15 | A-9 | 18,15 |
| 63-2" | M55008 | 15 | A-4 | 28,49 |



CON REFUERZO METÁLICO

J-65

| Medida | Ref. | U/ | / n.º | € |
|---------|--------|-----|-------|--------|
| 20-½" | M55183 | 100 | A-8 | 5,71 |
| 20-¾" | M55358 | 100 | A-8 | 5,75 |
| 25-½" | M55224 | 50 | A-11 | 7,49 |
| 25-¾" | M55184 | 100 | A-9 | 7,69 |
| 25-1" | M55359 | 100 | A-9 | 7,56 |
| 32-¾" | M55245 | 50 | A-9 | 10,38 |
| 32-1" | M55185 | 50 | A-9 | 10,38 |
| 32-1 ¼" | M55360 | 50 | A-9 | 11,59 |
| 40-1" | M55362 | 50 | A-4 | 13,74 |
| 40-1 ¼" | M55186 | 50 | A-4 | 15,50 |
| 50-1 ¼" | M55363 | 15 | A-9 | 17,86 |
| 50-1 ½" | M55187 | 15 | A-9 | 19,45 |
| 63-2" | M55141 | 15 | A-4 | 30,66 |
| 75-2 ½" | M55142 | 5 | A-9 | 73,09 |
| 90-3" | M55143 | 5 | A-4 | 96,55 |
| 110-4" | M55227 | 2 | A-4 | 170,77 |

Te 90º rosca hembra.



SIN REFUERZO METÁLICO

J-65

| Medida | Ref. | U/ | / n.º | € |
|----------|--------|----|-------|------|
| 32-1"-25 | M55327 | 50 | A-9 | 8,16 |



J-65

CON REFUERZO METÁLICO

| Medida | Ref. | U/ | / n.º | € |
|----------|--------|----|-------|------|
| 32-1"-25 | M55361 | 50 | A-9 | 9,46 |

Te 90º rosca hembra reducida.



SIN REFUERZO METÁLICO

J-72

| Medida | Ref. | U/ | / n.º | € |
|--------|--------|----|-------|------|
| 20-½" | M55076 | 50 | A-2 | 5,26 |
| 25-¾" | M55077 | 50 | A-11 | 5,67 |



CON REFUERZO METÁLICO

J-72

| Medida | Ref. | U/ | / n.º | € |
|--------|--------|----|-------|------|
| 20-½" | M55179 | 50 | A-2 | 6,44 |
| 25-¾" | M55180 | 50 | A-11 | 7,15 |

Codo grifo 90º.



J-78

| Medida | Ref. | U/ | / n.º | € |
|--------|--------|----|-------|-------|
| 16 | M55372 | 50 | A-1 | 2,86 |
| 20 | M55104 | 50 | A-1 | 3,15 |
| 25 | M55105 | 50 | A-2 | 3,52 |
| 32 | M55106 | 25 | A-2 | 5,52 |
| 40 | M55107 | 25 | A-11 | 6,80 |
| 50 | M55108 | 10 | A-2 | 10,05 |
| 63 | M55109 | 10 | A-11 | 14,44 |
| 75 | M55110 | 5 | A-11 | 25,73 |
| 90 | M55111 | 5 | A-8 | 42,15 |
| 110 | M55223 | 2 | A-2 | 85,28 |

Tapón final.



J-61

| Medida | Ref. | U/ | / n.º | € |
|-----------|--------|-----|-------|-------|
| 16-3/8" | M55148 | 50 | A-10 | 1,97 |
| 16-1/2" | M55147 | 50 | A-10 | 1,97 |
| 16-3/4" | M55336 | 50 | A-10 | 1,94 |
| 20-1/2" | M55011 | 100 | A-2 | 2,42 |
| 20-3/4" | M55132 | 50 | A-1 | 3,34 |
| 25-1/2" | M55133 | 50 | A-2 | 3,34 |
| 25-3/4" | M55012 | 100 | A-11 | 3,03 |
| 25-1" | M55213 | 50 | A-2 | 3,15 |
| 32-3/4" | M55214 | 50 | A-11 | 4,88 |
| 32-1" | M55013 | 100 | A-9 | 4,88 |
| 32-1 1/4" | M55215 | 50 | A-11 | 4,88 |
| 32-1 1/2" | M55337 | 50 | A-11 | 4,79 |
| 40-1" | M55216 | 50 | A-9 | 6,50 |
| 40-1 1/4" | M55014 | 100 | A-12 | 6,50 |
| 40-1 1/2" | M55338 | 100 | A-4 | 7,52 |
| 40-2" | M55339 | 100 | A-4 | 7,52 |
| 50-1 1/4" | M55303 | 25 | A-4 | 8,50 |
| 50-1 1/2" | M55001 | 25 | A-8 | 8,68 |
| 50-2" | M55340 | 25 | A-8 | 10,98 |
| 63-1 1/2" | M55341 | 25 | A-4 | 12,88 |
| 63- 2" | M55002 | 25 | A-4 | 13,13 |
| 75-2 1/2" | M55015 | 5 | A-11 | 33,77 |
| 90-3" | M55016 | 5 | A-9 | 40,01 |
| 110-4" | M55192 | 2 | A-11 | 81,62 |

Enlace mixto rosca macho.



J-79

| Medida | Ref. | U/ | / n.º | € |
|---------|--------|----|-------|-------|
| 25-3/4" | M55230 | 10 | A-10 | 7,38 |
| 32-1" | M55231 | 10 | A-1 | 11,06 |

Manguito pasamuros.



J-62

SIN REFUERZO METÁLICO

| Medida | Ref. | U/ | / n.º | € |
|-----------|--------|-----|-------|-------|
| 16-1/2" | M55152 | 50 | A-10 | 2,15 |
| 20-1/2" | M55035 | 100 | A-2 | 2,98 |
| 20-3/4" | M55687 | 50 | A-1 | 2,91 |
| 20-1" | M55342 | 100 | A-2 | 2,91 |
| 25-1/2" | M55134 | 50 | A-2 | 3,75 |
| 25-3/4" | M55036 | 100 | A-11 | 3,75 |
| 25-1" | M55246 | 50 | A-2 | 3,75 |
| 32-3/4" | M55320 | 50 | A-11 | 4,89 |
| 32-1" | M55037 | 100 | A-9 | 4,99 |
| 32-1 1/4" | M55321 | 50 | A-11 | 4,89 |
| 40-1" | M55322 | 50 | A-9 | 6,72 |
| 40-1 1/4" | M55038 | 50 | A-8 | 6,84 |
| 40-1 1/2" | M55343 | 50 | A-8 | 6,72 |
| 50-1 1/4" | M55323 | 25 | A-8 | 9,22 |
| 50-1 1/2" | M55005 | 25 | A-8 | 9,22 |
| 50-2" | M55344 | 25 | A-8 | 9,44 |
| 63-2" | M55006 | 25 | A-4 | 14,01 |



J-62

CON REFUERZO METÁLICO

| Medida | Ref. | U/ | / n.º | € |
|-----------|--------|-----|-------|--------|
| 20-1/2" | M55169 | 100 | A-2 | 3,57 |
| 20-3/4" | M55345 | 50 | A-1 | 3,50 |
| 25-1/2" | M55170 | 50 | A-2 | 4,45 |
| 25-3/4" | M55171 | 100 | A-11 | 4,45 |
| 25-1" | M55247 | 50 | A-2 | 4,45 |
| 32-3/4" | M55347 | 50 | A-11 | 5,65 |
| 32-1" | M55172 | 100 | A-9 | 5,76 |
| 32-1 1/4" | M55348 | 50 | A-11 | 5,65 |
| 40-1" | M55349 | 50 | A-8 | 7,86 |
| 40-1 1/4" | M55173 | 50 | A-8 | 8,02 |
| 40-1 1/2" | M55350 | 50 | A-8 | 8,02 |
| 50-1 1/4" | M55351 | 25 | A-8 | 11,10 |
| 50-1 1/2" | M55174 | 25 | A-8 | 11,31 |
| 50-2" | M55352 | 25 | A-8 | 12,42 |
| 63-2" | M55144 | 25 | A-4 | 16,60 |
| 75-2 1/2" | M55145 | 5 | A-11 | 40,82 |
| 90-3" | M55146 | 5 | A-8 | 109,99 |
| 110-4" | M55226 | 2 | A-11 | 102,90 |

Enlace mixto rosca hembra.

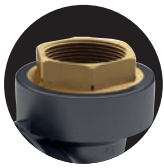

J-62

| Medida | Ref. | U/ | / n.º | € |
|---------|--------|----|-------|-------|
| 20-½" | M55710 | 50 | A-2 | 18,13 |
| 25-¾" | M55711 | 60 | A-11 | 21,25 |
| 32-1" | M55712 | 50 | A-9 | 24,05 |
| 40-1 ¼" | M55713 | 25 | A-2 | 32,76 |
| 50-1 ½" | M55714 | 12 | A-2 | 40,30 |
| 63-2" | M55715 | 12 | A-8 | 58,54 |

Enlace mixto rosca hembra con inserto de latón.



J-71

| Medida | Ref. | U/ | / n.º | € |
|---------|--------|----|-------|-------|
| 20-½" | M55723 | 25 | A-2 | 29,27 |
| 25-¾" | M55724 | 25 | A-2 | 31,85 |
| 32-1" | M55725 | 12 | A-1 | 33,01 |
| 40-1 ¼" | M55726 | 15 | A-11 | 33,01 |
| 50-1 ½" | M55727 | 10 | A-11 | 40,37 |
| 63-2" | M55728 | 10 | A-8 | 50,20 |

Enlace acodado 90º rosca hembra con inserto de latón.



J-61

| Medida | Ref. | U/ | / n.º | € |
|---------|--------|----|-------|-------|
| 20-½" | M55701 | 50 | A-2 | 21,24 |
| 25-¾" | M55702 | 60 | A-11 | 21,72 |
| 32-¾" | M55703 | 30 | A-11 | 23,95 |
| 32-1" | M55704 | 50 | A-9 | 23,95 |
| 32-1 ¼" | M55705 | 25 | A-11 | 30,77 |
| 32-1 ½" | M55729 | 25 | A-9 | 30,77 |
| 40-1" | M55706 | 25 | A-8 | 30,94 |
| 40-1 ¼" | M55707 | 40 | A-12 | 32,77 |
| 40-1 ½" | M55730 | 25 | A-9 | 32,76 |
| 50-1 ¼" | M55731 | 12 | A-2 | 40,30 |
| 50-1 ½" | M55708 | 12 | A-2 | 40,30 |
| 63-2" | M55709 | 12 | A-8 | 58,54 |

Enlace mixto rosca macho con inserto de latón.



J-69

| Medida | Ref. | U/ | / n.º | € |
|---------|--------|----|-------|-------|
| 20-½" | M55716 | 25 | A-2 | 29,93 |
| 25-¾" | M55717 | 25 | A-2 | 31,67 |
| 32-¾" | M55718 | 12 | A-2 | 34,02 |
| 32-1" | M55719 | 12 | A-2 | 34,02 |
| 40- 1" | M55732 | 12 | A-11 | 37,77 |
| 40-1 ¼" | M55720 | 15 | A-11 | 39,57 |
| 40-1 ½" | M55733 | 15 | A-11 | 39,57 |
| 40-1 ¾" | M55734 | 10 | A-2 | 49,20 |
| 50-1 ½" | M55721 | 10 | A-11 | 49,20 |
| 63-2" | M55722 | 10 | A-8 | 69,65 |

Enlace acodado 90º rosca macho con inserto de latón.



FITTING UTC/PE

Para la conexión de tubería de PE Métrico a Cobre, PVC, ABS, Acero Inoxidable, Hierro Galvanizado y Plomo

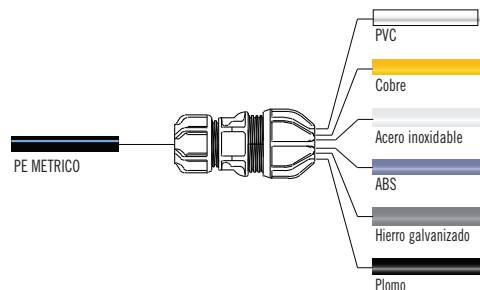

Conexión de PE con una gran variedad de tubos

PVC, cobre, hierro galvanizado, ABS, plomo, acero inoxidable, acero y polietileno.

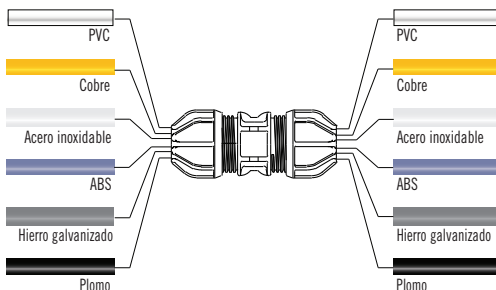

Conexión de una gran variedad de tubos entre sí

PVC, cobre, hierro galvanizado, ABS, plomo, acero inoxidable, acero y polietileno.

INSTALACIÓN RÁPIDA Y FÁCIL - Sistema desliza y aprieta

Completa seguridad

Accesorio premontado, sin riesgo de dañar las tuberías al montar.

Materiales de alto rendimiento

Fabricado con materiales termoplásticos tecnológicamente avanzados.

El Sistema UTC® está clasificado para una presión nominal de 12,5 bar a 20° C..

Cobertura completa

Conectando una amplia variedad de tuberías incluyendo.

Cobre, acero inoxidable, ABS, Hierro galvanizado y plomo.



WRAS Approval. (United Kingdom)
Cert. n : 1804340

MATERIALES Y COMPONENTES

CONEXIÓN TUBO PE

TUERCA - Acetal

CUERPO - Polipropileno

CASQUILLO PARTIDO - Acetal

JUNTA - Caucho nitrilo

CONEXIÓN UTC

TUERCA - Polipropileno
(34-39, 47-49 y 59-61 - Acetal)

CUERPO - Polipropileno

CASQUILLO PARTIDO - Acetal
con dientes de acero inoxidable

MATERIALES Y COMPONENTES

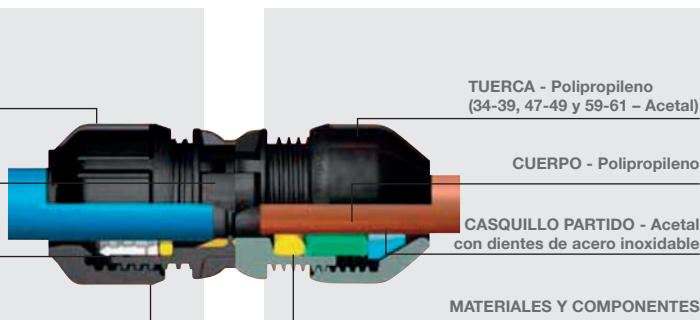



J-63

| Medida | Ref. | U/ | / n.º | € |
|----------|---------------|----|-------|---------------|
| 15-21x20 | M55453 | 5 | A-10 | 29,92 |
| 21-27x25 | M55457 | 5 | A-10 | 35,76 |
| 27-34x32 | M55459 | 5 | A-10 | 50,76 |
| 34-39x40 | M55462 | 5 | A-10 | 75,81 |
| 47-49x50 | M55463 | 5 | A-2 | 93,06 |
| 47-49x63 | M55464 | 5 | A-11 | 106,39 |
| 59-61x63 | M55465 | 5 | A-2 | 123,18 |

Enlace recto transición UTC/PE.



J-61

| Medida | Ref. | U/ | / n.º | € |
|--------------|---------------|----|-------|---------------|
| 15-21x 3/4" | M55485 | 5 | A-10 | 108,65 |
| 21-27x1" | M55488 | 5 | A-10 | 119,20 |
| 27-34x1 1/2" | M55493 | 5 | A-10 | 112,61 |

Enlace mixto r/macho transición UTC/BSP



J-95

| Medida | Ref. | U/ | / n.º | € |
|-------------|---------------|----|-------|---------------|
| 15-21x15-21 | M55471 | 5 | A-10 | 40,55 |
| 21-27x21-27 | M55472 | 5 | A-10 | 44,43 |
| 27-34x27-34 | M55473 | 5 | A-10 | 61,98 |
| 34-39x34-39 | M55474 | 5 | A-10 | 85,44 |
| 39-43x39-43 | M55475 | 5 | A-10 | 97,75 |
| 47-49x47-49 | M55476 | 5 | A-10 | 129,70 |
| 59-61x59-61 | M55477 | 5 | A-10 | 138,30 |

Enlace recto reparación UTC/UTC.



J-64

| Medida | Ref. | U/ | / n.º | € |
|----------|---------------|----|-------|--------------|
| 21-27x25 | M55467 | 5 | A-10 | 38,01 |
| 27-34x32 | M55470 | 5 | A-10 | 28,62 |

Enlace acodado transición UTC/PE.



J-68

| Medida | Ref. | U/ | / n.º | € |
|-------------|---------------|----|-------|--------------|
| 21-27x15-21 | M55478 | 5 | A-10 | 44,83 |
| 27-34x21-27 | M55480 | 5 | A-10 | 62,57 |
| 39-43x27- | M55482 | 5 | A-2 | 84,87 |

Enlace reducido reparación UTC/UTC.



J-64

| Medida | Ref. | U/ | / n.º | € |
|-------------|---------------|----|-------|--------------|
| 21-27x15-21 | M55483 | 5 | A-10 | 30,89 |
| 27-34x21-27 | M55484 | 5 | A-10 | 40,92 |

Enlace acodado UTC/UTC.



MAGNUM 3G

SERIE HCR Sistema para unión de tuberías a presión de alta resistencia a la corrosión.

- Sistema Fácil y rápido de instalar
- Seguro y Fiable
- Avanzado e innovador

Sistema MAGNUM 3G SERIE HCR

La nueva serie HCR Magnum 3G aporta una alternativa eficaz a materiales tradicionales en la instalación de acometidas

para agua potable en edificación e infraestructura, donde materiales como el latón sufren corrosión y deterioro acelerado

debido a los tratamientos para desinfección del agua potable.

Principales características y ventajas del sistema.

Los materiales de la serie HCR MAGNUM 3G están certificados ACS/ AENOR y son aptos para uso en aplicaciones para agua potable.

para agua potable.

- Resistencia química.
- Resistencia a la corrosión y a la abrasión.
- Resistencia a la radiación UV.

Áreas de aplicación.

Los materiales tecnológicamente avanzados confieren al SISTEMA MAGNUM 3G características únicas siendo apto para agua potable y adecuado para el transporte de fluidos a presión en infraestructura, edificación e industria, con una fiabilidad total. 1.600Kpa (PN16) a 20 °C + FOTOS o iconos de los segmentos.

Certificaciones



ACS (Francia),

Fitting materials approved for use in drinking water applications. XP P 41-280. Cert. n. : M3G 15 ACC LY 351 - M3G HCR 15 ACC LY 406.

J-62



| Medida | Ref. | U/ | U/bolsa | / n.º | € |
|---------|-----------------|-----|---------|-------|--------------|
| 20-½" | HCR55035 | 100 | 10 | A-2 | 6,15 |
| 20-¾" | HCR55687 | 50 | 10 | A-1 | 6,15 |
| 25-½" | HCR55134 | 50 | 10 | A-2 | 6,43 |
| 25-¾" | HCR55036 | 100 | 10 | A-8 | 6,43 |
| 25-1" | HCR55246 | 50 | 10 | A-2 | 6,43 |
| 32-¾" | HCR55320 | 50 | 5 | A-11 | 9,08 |
| 32-1" | HCR55037 | 100 | 5 | A-9 | 9,08 |
| 32-1 ¼" | HCR55321 | 50 | 5 | A-11 | 10,95 |

Enlace mixto rosca hembra HCR.

J-61



| Medida | Ref. | U/ | U/bolsa | / n.º | € |
|---------|-----------------|-----|---------|-------|--------------|
| 20-½" | HCR55011 | 100 | 10 | A-2 | 6,00 |
| 20-¾" | HCR55132 | 50 | 10 | A-1 | 6,00 |
| 25-½" | HCR55213 | 50 | 10 | A-2 | 6,44 |
| 25-¾" | HCR55133 | 100 | 10 | A-2 | 6,44 |
| 25-1" | HCR55012 | 50 | 10 | A-8 | 6,44 |
| 32-¾" | HCR55214 | 50 | 5 | A-11 | 8,34 |
| 32-1" | HCR55013 | 100 | 5 | A-9 | 8,34 |
| 32-1 ¼" | HCR55215 | 50 | 5 | A-11 | 12,22 |

Enlace mixto rosca macho HCR.



J-65

| Medida | Ref. | U/📦 | U/bolsa | 📦 / n.º | € |
|----------|-----------------|-----|---------|---------|--------------|
| 15-21x20 | HCR55024 | 100 | 10 | A-2 | 44,48 |
| 21-27x25 | HCR55244 | 50 | 5 | A-9 | 55,11 |
| 59-61x63 | HCR55025 | 50 | 5 | A-9 | 55,11 |

Te 90º rosca hembra HCR



J-69

| Medida | Ref. | U/📦 | U/bolsa | 📦 / n.º | € |
|--------|-----------------|-----|---------|---------|--------------|
| 25-¾" | HCR55097 | 50 | 10 | A-2 | 14,33 |
| 25-1" | HCR55314 | 50 | 10 | A-2 | 14,33 |
| 32-¾" | HCR55315 | 25 | 5 | A-2 | 17,20 |
| 32-1" | HCR55098 | 25 | 5 | A-2 | 17,20 |

Enlace acodado 90º rosca macho HCR.



J-67

| Medida | Ref. | U/📦 | U/bolsa | 📦 / n.º | € |
|--------|-----------------|-----|---------|---------|-------------|
| 25-¾" | HCR55422 | 50 | 10 | A-2 | 7,88 |
| 25-1" | HCR55423 | 50 | 10 | A-2 | 8,52 |
| 32-¾" | HCR55424 | 25 | 5 | A-2 | 8,70 |
| 32-1" | HCR55425 | 25 | 5 | A-2 | 9,65 |

Enlace mixto rosca hembra, con tuerca loca HCR.



J-99

| Medida | Ref. | U/📦 | U/bolsa | 📦 / n.º | € |
|--------|-----------------|-----|---------|---------|--------------|
| 25-¾" | HCR55413 | 50 | 10 | A-2 | 22,71 |
| 25-1" | HCR55414 | 50 | 10 | A-2 | 22,71 |
| 32-¾" | HCR55415 | 25 | 5 | A-2 | 26,50 |
| 32-1" | HCR55416 | 25 | 5 | A-2 | 26,50 |

Enlace acodado 90º rosca hembra, con tuerca loca HCR.



J-72

| Medida | Ref. | U/📦 | U/bolsa | 📦 / n.º | € |
|--------|-----------------|-----|---------|---------|--------------|
| 25-¾" | HCR55077 | 50 | 10 | A-11 | 43,16 |

Codo grifo 90º HCR.



| Medida | Ref. | U/ | / n.º | € |
|---------|-------|----|-------|-------|
| 20-3/4" | 52330 | 50 | A-11 | 34,20 |
| 25-3/4" | 52331 | 50 | A-11 | 35,18 |
| 32-3/4" | 52332 | 50 | A-8 | 41,24 |

Válvula esfera para contador - HCR. Enlace fitting.



| Medida | Ref. | U/ | / n.º | € |
|-----------|-------|----|-------|-------|
| 1/2"-3/4" | 52333 | 50 | A-11 | 33,09 |
| 3/4"-3/4" | 52334 | 50 | A-11 | 33,53 |
| 1"-3/4" | 52335 | 50 | A-11 | 38,28 |

Válvula esfera para contador - HCR. Conexión rosca macho



| Medida | Ref. | U/ | / n.º | € |
|---------|-------|----|-------|-------|
| 25-3/4" | 52336 | 50 | A-11 | 47,29 |
| 32-3/4" | 52337 | 50 | A-8 | 55,63 |

Válvula esfera ángulo para contador - HCR. Enlace fitting.



| Medida | Ref. | U/ | / n.º | € |
|-----------|-------|----|-------|-------|
| 3/4"-3/4" | 52338 | 50 | A-11 | 33,53 |
| 1"-3/4" | 52339 | 50 | A-11 | 38,28 |

Válvula esfera ángulo para contador - HCR. Conexión rosca macho.



| Medida | Ref. | U/ | / n.º | € |
|--------|---------------|----|-------|-------------|
| 16 | M55157 | 50 | 4115 | 0,50 |
| 20 | M55052 | 50 | 4115 | 0,59 |
| 25 | M55053 | 50 | 4115 | 0,65 |
| 32 | M55054 | 50 | A-10 | 1,06 |
| 40 | M55055 | 50 | A-10 | 1,47 |
| 50 | M55056 | 25 | A-10 | 1,80 |
| 63 | M55057 | 25 | A-10 | 2,59 |

Junta de estanqueidad Magnum 3G y Magnum 3G-HCR.



| Medida | Ref. | U/ | / n.º | € |
|--------|---------------|----|-------|-------------|
| 20 | M55400 | 50 | A-2 | 0,58 |
| 25 | M55401 | 50 | A-2 | 0,64 |
| 32 | M55402 | 50 | A-2 | 1,05 |
| 40 | M55403 | 50 | A-2 | 1,44 |
| 50 | M55056 | 25 | A-10 | 1,80 |
| 63 | M55057 | 25 | A-10 | 2,59 |

Junta de estanqueidad accesorios reparaciones Magnum 3G.



| Medida | Ref. | U/ | / n.º | € |
|--------|---------------|----|-------|-------------|
| 16 | M55232 | 50 | A-10 | 0,63 |
| 20 | M55233 | 50 | A-10 | 0,66 |
| 25 | M55234 | 50 | A-1 | 0,71 |
| 32 | M55235 | 50 | A-2 | 1,14 |
| 40 | M55236 | 50 | A-11 | 1,94 |
| 50 | M55237 | 25 | A-11 | 3,11 |
| 63 | M55238 | 25 | A-8 | 5,41 |

Racor Magnum 3G.



| Medida | Ref. | U/ | / n.º | € |
|--------|-----------------|----|-------|-------------|
| 20 | HCR55233 | 50 | A-10 | 0,86 |
| 25 | HCR55234 | 50 | A-10 | 1,03 |
| 32 | HCR55235 | 50 | A-2 | 1,31 |

Racor Magnum 3G - HCR.



| Medida | Ref. | U/ | / n.º | € |
|--------|---------------|----|-------|--------------|
| 16 | M55156 | 50 | A-10 | 0,50 |
| 20 | M55046 | 50 | A-10 | 0,59 |
| 25 | M55047 | 50 | A-10 | 0,81 |
| 32 | M55048 | 50 | A-10 | 0,93 |
| 40 | M55049 | 50 | A-10 | 1,07 |
| 50 | M55050 | 25 | A-10 | 1,50 |
| 63 | M55051 | 25 | A-1 | 1,62 |
| 75 | M55064 | 15 | A-1 | 14,30 |
| 90 | M55065 | 15 | A-2 | 18,84 |
| 110 | M55168 | 15 | A-2 | 28,00 |

Casquillo partido Magnum 3G.





| Medida | Ref. | U/ | / n.º | € |
|--------|-----------------|----|-------|-------------|
| 16 | HCR55046 | 50 | 4115 | 0,58 |
| 20 | HCR55047 | 50 | 4115 | 0,79 |
| 63 | HCR55048 | 50 | A-10 | 0,91 |

Casquillo partido Magnum 3G - HCR.

| Medida | Ref. | U/ | / n.º | € |
|--------|---------------|----|-------|--------------|
| 20 | M55406 | 20 | A-10 | 3,67 |
| 25 | M55407 | 20 | A-10 | 3,71 |
| 32 | M55408 | 20 | A-10 | 4,78 |
| 40 | M55409 | 10 | A-10 | 5,41 |
| 50 | M55410 | 10 | A-10 | 6,79 |
| 63 | M55411 | 10 | A-1 | 11,61 |



Casquillo partido Magnum 3G especial tubo PVC.



| Medida | Ref. | U/  |  / n.º | € |
|--------|---------------|--|---|---------------|
| 16-32 | 055248 | 20 | A-10 | 40,94 |
| 40-63 | 055249 | 20 | A-2 | 57,54 |
| 75-110 | 055250 | 10 | A-8 | 114,34 |

Llave de apriete fitting Gama'55.



| Medida | Ref. | U/  |  / n.º | € |
|---------|-----------------|--|---|--------------|
| 16 a 63 | 055690 ● | 10 | A-2 | 22,90 |

Llave de apriete fitting universal.

0940
Accesorios en PP para tubería de PE

Codos

Máquinas de soldadura

Enlaces

Tapones / Llaves de apriete

Collarines

0802
Válvulas manuales de PVC-U presión

Válvulas de bola 2 vías



Fitting Astore





Codos



513

| d | Ref. | PN | U/ | € |
|-----|--------------|----|-----|-------|
| 16 | GG51316000 | 16 | 360 | 1,41 |
| 20 | GG51320000 ● | 16 | 200 | 1,64 |
| 25 | GG51325000 ● | 16 | 150 | 2,10 |
| 32 | GG51332000 ● | 16 | 80 | 2,92 |
| 40 | GG51340000 ● | 16 | 50 | 4,54 |
| 50 | GG51350000 ● | 16 | 30 | 7,34 |
| 63 | GG51363000 ● | 16 | 15 | 11,48 |
| 75 | GR51375000 ● | 10 | 11 | 15,47 |
| 90 | GR51390000 ● | 10 | 8 | 21,25 |
| 110 | GR51311000 ● | 10 | 4 | 27,84 |

Codo 90°
H-H



519

| d x Rh | Ref. | PN | 2 | € |
|-------------|--------------|----|-----|-------|
| 16 x 1/2" | GG51916B00 | 16 | 400 | 1,01 |
| 20 x 1/2" | GG51920B00 ● | 16 | 260 | 1,04 |
| 20 x 3/4" | GG51920C00 | 16 | 260 | 1,24 |
| 25 x 1/2" | GG51925B00 | 16 | 180 | 1,77 |
| 25 x 3/4" | GG51925C00 ● | 16 | 180 | 1,57 |
| 25 x 1" | GG51925D00 | 16 | 180 | 1,57 |
| 32 x 1" | GG51932D00 ● | 16 | 110 | 2,00 |
| 32 x 1 1/4" | GG51932E00 | 16 | 110 | 1,82 |
| 40 x 1 1/4" | GG51940E00 ● | 16 | 60 | 3,74 |
| 40 x 1 1/2" | GG51940F00 | 16 | 60 | 3,69 |
| 50 x 1 1/2" | GG51950F00 ● | 16 | 35 | 5,53 |
| 50 x 2" | GG51950G00 | 16 | 35 | 5,59 |
| 63 x 2" | GG51963G00 ● | 16 | 20 | 7,51 |
| 63 x 2 1/2" | GG51963H00 | 16 | 20 | 7,89 |
| 75 x 2 1/2" | GR51975H00 | 10 | 14 | 10,05 |
| 75 x 3" | GR51975I00 | 10 | 14 | 10,16 |
| 90 x 3" | GR51990I00 ● | 10 | 10 | 15,29 |
| 110 x 4" | GR51911L00 | 10 | 5 | 19,43 |

Codo 90° rosca macho.
H-M



518

| d x Rh | Ref. | PN | U/ | € |
|-------------|--------------|----|-----|-------|
| 16 x 3/8" | GG51816A00 | 16 | 400 | 1,94 |
| 16 x 1/2" | GG51816B00 | 16 | 400 | 2,56 |
| 20 x 1/2" | GG51820B00 ● | 16 | 260 | 1,94 |
| 20 x 3/4" | GG51820C00 | 16 | 260 | 2,63 |
| 25 x 1/2" | GG51825B00 | 16 | 180 | 2,83 |
| 25 x 3/4" | GG51825C00 ● | 16 | 180 | 2,95 |
| 25 x 1" | GG51825D00 | 16 | 160 | 2,95 |
| 32 x 1/2" | GG51832B00 ● | 16 | 110 | 3,60 |
| 32 x 3/4" | GG51832C00 ● | 16 | 110 | 3,60 |
| 32 x 1" | GG51832D00 ● | 16 | 110 | 3,60 |
| 32 x 1 1/4" | GG51832E00 | 16 | 60 | 4,16 |
| 40 x 1 1/4" | GG51840E00 ● | 16 | 60 | 6,11 |
| 40 x 1 1/2" | GG51840F00 | 16 | 60 | 6,11 |
| 50 x 1/2" | GG51850F00 ● | 16 | 35 | 6,94 |
| 50 x 2" | GG51850G00 | 16 | 35 | 7,17 |
| 63 x 2" | GG51863G00 ● | 16 | 20 | 11,04 |
| 63 x 2 1/2" | GG51863H00 | 16 | 20 | 11,68 |
| 75 x 2 1/2" | GR51875H00 ● | 16 | 14 | 12,44 |
| 75 x 3" | GR51875I00 | 10 | 14 | 13,44 |
| 90 x 3" | GR51890I00 ● | 10 | 10 | 17,09 |
| 110 x 4" | GR51811L00 | 10 | 5 | 21,07 |

Codo 90°
H-H



524

| d x Rh | Ref. | PN | U/ | € |
|-----------|------------|----|-----|------|
| 25 x 3/4" | GG52425C00 | 16 | 150 | 2,86 |

Codo grifo 90°.
H-H

Las piezas rosca hembra de diámetro 40 mm o superior llevan anillo de refuerzo en acero inox.



514



| d | Ref. | PN | U/ | € |
|----------|------------|----|-----|-------|
| 16 | GG51416000 | 16 | 220 | 1,94 |
| 20 | GG51420000 | 16 | 120 | 2,40 |
| 20-25-20 | GG51420C00 | 16 | 120 | 2,83 |
| 25 | GG51425000 | 16 | 90 | 2,92 |
| 25-32-25 | GG51425D00 | 16 | 70 | 4,96 |
| 32 | GG51432000 | 16 | 50 | 4,20 |
| 40 | GG51440000 | 16 | 30 | 6,50 |
| 50 | GG51450000 | 16 | 20 | 10,21 |
| 63 | GG51463000 | 16 | 12 | 15,68 |
| 75 | GR51475000 | 10 | 7 | 25,81 |
| 90 | GR51490000 | 10 | 5 | 30,37 |
| 110 | GR51411000 | 10 | 3 | 42,21 |

Te a 90°
H-H-H



516

| d x Rm X d | Ref. | PN | U/ | € |
|------------------|------------|----|-----|-------|
| 16 x 1/2" x 16 | GG51616B00 | 16 | 240 | 1,43 |
| 20 x 1/2" x 20 | GG51620B00 | 16 | 140 | 1,61 |
| 20 x 3/4" x 20 | GG51620C00 | 16 | 140 | 1,88 |
| 25 x 3/4" x 25 | GG51625C00 | 16 | 100 | 2,95 |
| 25 x 1" x 25 | GG51625D00 | 16 | 100 | 3,14 |
| 32 x 1" x 32 | GG51632D00 | 16 | 60 | 3,33 |
| 32 x 1 1/4" x 32 | GG51632D00 | 16 | 60 | 3,33 |
| 40 x 1 1/4" x 40 | GG51640E00 | 16 | 30 | 6,31 |
| 40 x 1 1/2" x 40 | GG51640F00 | 16 | 30 | 6,24 |
| 50 x 1 1/2" x 50 | GG51650F00 | 16 | 20 | 9,23 |
| 50 x 2" x 50 | GG51650G00 | 16 | 20 | 9,61 |
| 63 x 2" x 63 | GG51663G00 | 16 | 12 | 11,42 |
| 63 x 2 1/2" x 63 | GG51663H00 | 16 | 12 | 11,42 |
| 75 x 2 1/2" x 75 | GR51675H00 | 10 | 10 | 15,72 |
| 90 x 3" x 90 | GR51690I00 | 10 | 6 | 23,91 |
| 110 x 4" x 110 | GR51611L00 | 10 | 3 | 32,20 |

Te a 90° rosca macho igual y reducida.
H-M-H

515



| d x Rh X d | Ref. | PN | U/ | € |
|------------------|------------|----|-----|-------|
| 16 x 3/8" x 16 | GG51516A00 | 16 | 240 | 2,88 |
| 16 x 1/2" x 16 | GG51516B00 | 16 | 240 | 2,72 |
| 20 x 1/2" x 20 | GG51520B00 | 16 | 140 | 2,92 |
| 20 x 3/4" x 20 | GG51520C00 | 16 | 140 | 2,92 |
| 25 x 1/2" x 25 | GG51525B00 | 16 | 100 | 3,10 |
| 25 x 3/4" x 25 | GG51525C00 | 16 | 100 | 3,10 |
| 25 x 1" x 25 | GG51525D00 | 16 | 100 | 3,63 |
| 32 x 1/2" x 32 | GG51532B00 | 16 | 60 | 3,74 |
| 32 x 3/4" x 32 | GG51532C00 | 16 | 60 | 3,74 |
| 32 x 1" x 32 | GG51532D00 | 16 | 60 | 3,74 |
| 32 x 1 1/4" x 32 | GG51532E00 | 16 | 50 | 4,74 |
| 40 x 1" x 40 | GG51540D00 | 16 | 30 | 6,06 |
| 40 x 1 1/4" x 40 | GG51540E00 | 16 | 30 | 5,70 |
| 40 x 1 1/2" x 40 | GG51540F00 | 16 | 30 | 6,13 |
| 50 x 1 1/2" x 50 | GG51550F00 | 16 | 20 | 9,40 |
| 50 x 2" x 50 | GG51550G00 | 16 | 20 | 11,46 |
| 63 x 2" x 63 | GG51563G00 | 16 | 12 | 13,08 |
| 63 x 2 1/2" x 63 | GG51563H00 | 16 | 12 | 13,08 |
| 75 x 2 1/2" x 75 | GR51575H00 | 10 | 10 | 19,79 |
| 90 x 3" x 90 | GR51590I00 | 10 | 6 | 25,70 |
| 110 x 4" x 110 | GR51511L00 | 10 | 3 | 33,29 |

Te a 90° rosca hembra igual y reducida.
H-H-H



523

| d x dr x d | Ref. | PN | U/ | € |
|--------------|------------|----|-----|-------|
| 25 x 20 x 25 | GG52325B00 | 16 | 100 | 3,39 |
| 32 x 25 x 32 | GG52332C00 | 16 | 60 | 3,47 |
| 40 x 32 x 40 | GG52340D00 | 16 | 30 | 7,44 |
| 50 x 40 x 50 | GG52350E00 | 16 | 20 | 10,37 |
| 63 x 50 x 63 | GG52363F00 | 16 | 12 | 13,92 |

Te a 90° reducida en el centro.
H-H-H



Enlaces



510

| d | Ref. | PN | U/☒ | € |
|-----|--------------|----|-----|-------|
| 16 | GG51016000 | 16 | 360 | 1,31 |
| 20 | GG51020000 ● | 16 | 200 | 1,59 |
| 25 | GG51025000 ● | 16 | 150 | 1,94 |
| 32 | GG51032000 ● | 16 | 80 | 2,52 |
| 40 | GG51040000 ● | 16 | 50 | 4,28 |
| 50 | GG51050000 ● | 16 | 30 | 6,94 |
| 63 | GG51063000 ● | 16 | 15 | 10,35 |
| 75 | GR51075000 ● | 10 | 11 | 12,04 |
| 90 | GR51090000 ● | 10 | 8 | 17,71 |
| 110 | GR51011000 ● | 10 | 4 | 23,46 |

Enlace recto.

H-H



601

| d x Rm | Ref. | PN | U/☒ | € |
|-------------|--------------|----|-----|-------|
| 16 x 3/8" | GG60116A00 | 16 | 500 | 1,79 |
| 16 x 1/2" | GG60116B00 | 16 | 500 | 1,77 |
| 20 x 1/2" | GG60120B00 ● | 16 | 400 | 1,35 |
| 20 x 3/4" | GG60120C00 | 16 | 340 | 1,35 |
| 25 x 1/2" | GG60125B00 | 16 | 250 | 1,83 |
| 25 x 3/4" | GG60125C00 ● | 16 | 250 | 1,81 |
| 25 x 1" | GG60125D00 | 16 | 200 | 1,87 |
| 32 x 1/2" | GG60132B00 | 16 | 150 | 1,96 |
| 32 x 3/4" | GG60132C00 ● | 16 | 150 | 1,96 |
| 32 x 1" | GG60132D00 ● | 16 | 150 | 1,92 |
| 32 x 1 1/4" | GG60132E00 | 16 | 130 | 2,88 |
| 40 x 1" | GG60140D00 | 16 | 90 | 3,87 |
| 40 x 1 1/4" | GG60140E00 ● | 16 | 90 | 5,16 |
| 40 x 1 1/2" | GG60140F00 ● | 16 | 90 | 5,16 |
| 50 x 1 1/4" | GG60150E00 | 16 | 55 | 6,00 |
| 50 x 1 1/2" | GG60150F00 ● | 16 | 55 | 6,00 |
| 50 x 2" | GG60150G00 | 16 | 55 | 6,88 |
| 63 x 1 1/2" | GG60163F00 | 16 | 30 | 7,24 |
| 63 x 2" | GG60163G00 ● | 16 | 30 | 7,08 |
| 75 x 2" | GR60175G00 | 10 | 25 | 9,34 |
| 75 x 2 1/2" | GR60175H00 ● | 10 | 25 | 9,89 |
| 75 x 3" | GR60175I00 | 10 | 25 | 10,04 |
| 90 x 2" | GR60190G00 | 10 | 16 | 11,62 |
| 90 x 2 1/2" | GR60190H00 | 10 | 16 | 12,55 |
| 90 x 3" | GR60190I00 ● | 10 | 16 | 11,84 |
| 110 x 3" | GG60111I00 | 10 | 8 | 19,85 |
| 110 x 4" | GR60111L00 | 10 | 8 | 22,38 |

Enlace rosca hembra.

H-M.



511

| d x Rm | Ref. | PN | U/☒ | € |
|-------------|--------------|----|-----|-------|
| 16 x 3/8" | GG51116A00 | 16 | 500 | 0,93 |
| 16 x 1/2" | GG51116B00 ● | 16 | 500 | 0,79 |
| 16 x 3/4" | GG51116C00 | 16 | 500 | 0,84 |
| 20 x 1/2" | GG51120B00 ● | 16 | 400 | 1,03 |
| 20 x 3/4" | GG51120C00 | 16 | 400 | 1,03 |
| 25 x 1/2" | GG51125B00 | 16 | 250 | 1,17 |
| 25 x 3/4" | GG51125C00 ● | 16 | 250 | 1,17 |
| 25 x 1" | GG51125D00 | 16 | 250 | 1,42 |
| 32 x 3/4" | GG51132C00 ● | 16 | 150 | 1,74 |
| 32 x 1" | GG51132D00 ● | 16 | 150 | 1,74 |
| 32 x 1 1/4" | GG51132E00 ● | 16 | 150 | 2,28 |
| 40 x 1" | GG51140D00 ● | 16 | 90 | 2,46 |
| 40 x 1 1/4" | GG51140E00 ● | 16 | 90 | 2,74 |
| 40 x 1 1/2" | GG51140F00 ● | 16 | 90 | 2,74 |
| 50 x 1 1/4" | GG51150E00 | 16 | 55 | 4,33 |
| 50 x 1 1/2" | GG51150F00 ● | 16 | 55 | 4,33 |
| 50 x 2" | GG51150G00 ● | 16 | 55 | 4,58 |
| 63 x 1 1/2" | GG51163F00 | 16 | 30 | 5,25 |
| 63 x 2" | GG51163G00 ● | 16 | 30 | 6,66 |
| 63 x 2 1/2" | GG51163H00 | 16 | 30 | 6,66 |
| 75 x 2" | GR51175G00 | 10 | 25 | 7,79 |
| 75 x 2 1/2" | GR51175H00 ● | 10 | 25 | 8,01 |
| 75 x 3" | GR51175I00 | 10 | 25 | 9,30 |
| 90 x 2" | GR51190G00 | 10 | 16 | 10,55 |
| 90 x 2 1/2" | GR51190H00 | 10 | 16 | 10,55 |
| 90 x 3" | GR51190I00 ● | 10 | 16 | 11,74 |
| 90 x 4" | GR51190L00 | 10 | 16 | 12,98 |
| 110 x 2" | GG51111G00 | 10 | 8 | 16,02 |
| 110 x 3" | GR51111I00 | 10 | 8 | 16,69 |
| 110 x 4" | GR51111L00 ● | 10 | 8 | 18,72 |

Enlace rosca macho.

H-M.



Accesorios en PP para tubería de PE

Tapones / Llaves de apriete

525



| d x Rh | Ref. | PN | U/ | € |
|---------|------------|----|-----|------|
| 25 x 1" | GG52525D00 | 16 | 200 | 3,96 |
| 32 x 1" | GG52532D00 | 16 | 140 | 4,43 |

Enlace con tuerca.
H-H

512



| d x dr | Ref. | PN | U/ | € |
|----------|------------|----|-----|-------|
| 20 x 16 | GG51220A00 | 16 | 260 | 1,61 |
| 25 x 20 | GG51225B00 | 16 | 180 | 1,94 |
| 32 x 20 | GG51232B00 | 16 | 110 | 2,23 |
| 32 x 25 | GG51232C00 | 16 | 110 | 2,28 |
| 40 x 25 | GG51240C00 | 16 | 70 | 3,87 |
| 40 x 32 | GG51240D00 | 16 | 70 | 4,28 |
| 50 x 25 | GG51250C00 | 16 | 40 | 4,58 |
| 50 x 32 | GG51250D00 | 16 | 40 | 4,60 |
| 50 x 40 | GG51250E00 | 16 | 40 | 5,14 |
| 63 x 32 | GG51263D00 | 16 | 25 | 6,37 |
| 63 x 40 | GG51263E00 | 16 | 25 | 6,37 |
| 63 x 50 | GG51263F00 | 16 | 20 | 6,50 |
| 75 x 50 | GR51275F00 | 10 | 15 | 8,92 |
| 75 x 63 | GR51275G00 | 10 | 15 | 8,92 |
| 90 x 63 | GR51290G00 | 10 | 12 | 13,59 |
| 90 x 75 | GR51290H00 | 10 | 12 | 14,92 |
| 110 x 75 | GG51211H00 | 10 | 6 | 21,77 |
| 110 x 90 | GR51211I00 | 10 | 6 | 25,75 |

Enlace reducido.
H-H.

520



| d x DN | Ref. | PN | U/ | € |
|-------------|------------|----|----|-------|
| 50 x 1½" | GG52050F00 | 12 | - | 23,77 |
| 63 x 2" | GG52063G00 | 10 | - | 23,31 |
| 75 x 2½" | GR52075H00 | 10 | 5 | 25,08 |
| 75 x 3" (A) | GR52075I00 | 10 | 6 | 25,00 |
| 90 x 3" | GR52090I00 | 10 | 3 | 26,69 |
| 90 x 4" (A) | GR52090L00 | 10 | 3 | 27,78 |
| 110 x 4" | GR52011L00 | 10 | 2 | 33,40 |

Enlace con brida metálica.
H-Brida

521



| d | Ref. | PN | U/ | € |
|-----|------------|----|-----|-------|
| 16 | GG52116000 | 16 | 500 | 1,01 |
| 20 | GG52120000 | 16 | 400 | 1,27 |
| 25 | GG52125000 | 16 | 250 | 1,44 |
| 32 | GG52132000 | 16 | 150 | 2,28 |
| 40 | GG52140000 | 16 | 90 | 2,81 |
| 50 | GG52150000 | 16 | 60 | 4,42 |
| 63 | GG52163000 | 16 | 30 | 6,66 |
| 75 | GR52175000 | 10 | 28 | 7,70 |
| 90 | GR52190000 | 10 | 22 | 10,43 |
| 110 | GR52111000 | 10 | 8 | 13,66 |

Tapón final.
H.

J-93



| Medida | Ref. | U/ | / n.º | € |
|---------|--------|----|-------|-------|
| 16 a 63 | 055690 | 10 | A-2 | 22,90 |

Llave de apriete fitting universal.



Accesorios en PP para tubería de PE

Collarines



503

| d x Rh | Ref. | PN | U/ | € |
|-------------|-------------|----|-----|------|
| 20 x 1/2" | 503020012 | 10 | 150 | 1,06 |
| 25 x 1/2" | 503025012 | 10 | 120 | 1,06 |
| 25 x 3/4" | 503025034 | 10 | 120 | 1,06 |
| 32 x 1/2" | 503032012 ● | 10 | 100 | 1,06 |
| 32 x 3/4" | 503032034 | 10 | 100 | 1,06 |
| 32 x 1" | 503032100 | 10 | 60 | 1,32 |
| 40 x 1/2" | 503040012 | 10 | 60 | 1,32 |
| 40 x 3/4" | 503040034 | 10 | 60 | 1,32 |
| 40 x 1" | 503040100 | 10 | 60 | 1,32 |
| 50 x 1/2" | 503050012 | 10 | 50 | 1,56 |
| 50 x 3/4" | 503050034 | 10 | 50 | 1,56 |
| 50 x 1" | 503050100 | 10 | 50 | 1,56 |
| 63 x 1/2" | 503063012 ● | 10 | 75 | 2,28 |
| 63 x 3/4" | 503063034 | 10 | 75 | 2,28 |
| 63 x 1" | 503063100 | 10 | 75 | 2,28 |
| 63 x 1 1/4" | 503063114 | 10 | 70 | 2,28 |
| 63 x 1 1/2" | 503063112 | 10 | 70 | 2,28 |
| 75 x 1/2" | 503075012 | 10 | 50 | 3,56 |
| 75 x 3/4" | 503075034 | 10 | 50 | 3,56 |
| 75 x 1" | 503075100 | 10 | 50 | 3,56 |
| 75 x 1 1/4" | 503075114 | 10 | 45 | 3,56 |
| 75 x 1 1/2" | 503075112 | 10 | 45 | 3,56 |
| 75 x 2" | 503075200 | 10 | 45 | 3,56 |

| d x Rh | Ref. | PN | U/ | € |
|--------------|-----------|----|----|-------|
| 90 x 1/2" | 503090012 | 10 | 40 | 4,20 |
| 90 x 3/4" | 503090034 | 10 | 40 | 4,20 |
| 90 x 1" | 503090100 | 10 | 40 | 4,20 |
| 90 x 1 1/4" | 503090114 | 10 | 35 | 4,20 |
| 90 x 1 1/2" | 503090112 | 10 | 35 | 4,20 |
| 90 x 2" | 503090200 | 10 | 35 | 4,20 |
| 110 x 1/2" | 503110012 | 10 | 25 | 4,98 |
| 110 x 3/4" | 503110034 | 10 | 25 | 4,98 |
| 110 x 1" | 503110100 | 10 | 25 | 4,98 |
| 110 x 1 1/4" | 503110114 | 10 | 25 | 4,98 |
| 110 x 1 1/2" | 503110112 | 10 | 25 | 4,98 |
| 110 x 2" | 503110200 | 10 | 25 | 4,98 |
| 110 x 3" | 503110300 | 10 | 20 | 11,58 |

Collarín en PP sin refuerzo.
Para riego y obra civil.



505

| d x Rh | Ref. | PN | U/ | €NBR |
|--------------|-----------|----|-----|-------|
| 20 x 1/2" | 505020012 | 10 | 150 | 1,76 |
| 25 x 1/2" | 505025012 | 10 | 120 | 1,82 |
| 25 x 3/4" | 505025034 | 10 | 120 | 1,82 |
| 32 x 1/2" | 505032012 | 10 | 100 | 2,00 |
| 32 x 3/4" | 505032034 | 10 | 100 | 2,00 |
| 32 x 1" | 505032100 | 10 | 60 | 2,08 |
| 40 x 1/2" | 505040012 | 10 | 60 | 2,14 |
| 40 x 3/4" | 505040034 | 10 | 60 | 2,14 |
| 40 x 1" | 505040100 | 10 | 60 | 2,14 |
| 50 x 1/2" | 505050012 | 10 | 50 | 2,28 |
| 50 x 3/4" | 505050034 | 10 | 50 | 2,28 |
| 50 x 1" | 505050100 | 10 | 75 | 2,28 |
| 63 x 1/2" | 505063012 | 10 | 75 | 2,98 |
| 63 x 3/4" | 505063034 | 10 | 75 | 2,98 |
| 63 x 1" | 505063100 | 10 | 70 | 2,98 |
| 63 x 1 1/4" | 505063114 | 10 | 70 | 2,98 |
| 63 x 1 1/2" | 505063112 | 10 | 50 | 2,98 |
| 75 x 1/2" | 505075012 | 10 | 50 | 3,80 |
| 75 x 3/4" | 505075034 | 10 | 50 | 3,80 |
| 75 x 1" | 505075100 | 10 | 45 | 3,80 |
| 75 x 1 1/4" | 505075114 | 10 | 45 | 3,80 |
| 75 x 1 1/2" | 505075112 | 10 | 45 | 3,80 |
| 75 x 2" | 505075200 | 10 | 40 | 3,80 |
| 90 x 1/2" | 505090012 | 10 | 40 | 4,32 |
| 90 x 3/4" | 505090034 | 10 | 40 | 4,32 |
| 90 x 1" | 505090100 | 10 | 35 | 4,32 |
| 90 x 1 1/4" | 505090114 | 10 | 35 | 4,32 |
| 90 x 1 1/2" | 505090112 | 10 | 25 | 4,32 |
| 90 x 2" | 505090200 | 10 | 25 | 4,32 |
| 110 x 1/2" | 505110012 | 10 | 25 | 5,10 |
| 110 x 3/4" | 505110034 | 10 | 25 | 5,10 |
| 110 x 1" | 505110100 | 10 | 25 | 5,10 |
| 110 x 1 1/4" | 505110114 | 10 | 25 | 5,10 |
| 110 x 1 1/2" | 505110112 | 10 | 25 | 5,10 |
| 110 x 2" | 505110200 | 10 | 25 | 5,10 |
| 110 x 3" | 505110300 | 10 | 20 | 10,80 |
| 125 x 3/4" | 505125034 | 10 | 30 | 7,92 |
| 125 x 1" | 505125100 | 10 | 30 | 7,92 |
| 125 x 1 1/4" | 505125114 | 10 | 30 | 7,92 |
| 125 x 1 1/2" | 505125112 | 10 | 30 | 7,92 |
| 125 x 2" | 505125200 | 10 | 30 | 7,92 |

| d x Rh | Ref. | PN | U/ | €NBR |
|--------------|-----------|----|----|--------|
| 140 x 1" | 505140100 | 10 | 20 | 10,30 |
| 140 x 1 1/4" | 505140114 | 10 | 20 | 10,30 |
| 140 x 1 1/2" | 505140112 | 10 | 20 | 10,30 |
| 140 x 2" | 505140200 | 10 | 20 | 10,30 |
| 140 x 2 1/2" | 505140212 | 6 | 20 | 14,36 |
| 140 x 3" | 505140300 | 10 | 20 | 14,36 |
| 160 x 3/4" | 505160034 | 10 | 16 | 14,50 |
| 160 x 1" | 505160100 | 10 | 16 | 14,50 |
| 160 x 1 1/4" | 505160114 | 10 | 16 | 14,50 |
| 160 x 1 1/2" | 505160112 | 10 | 16 | 14,50 |
| 160 x 2" | 505160200 | 10 | 16 | 14,50 |
| 160 x 3" | 505160300 | 6 | 15 | 20,70 |
| 180 x 1 1/4" | 505180114 | 6 | 8 | 54,90 |
| 180 x 1 1/2" | 505180112 | 6 | 8 | 54,90 |
| 180 x 2" | 505180200 | 6 | 8 | 54,90 |
| 180 x 3" | 505180300 | 6 | 8 | 54,90 |
| 180 x 4" | 505180400 | 6 | 6 | 54,90 |
| 200 x 1 1/4" | 505200114 | 6 | 8 | 57,30 |
| 200 x 1 1/2" | 505200112 | 6 | 8 | 57,30 |
| 200 x 2" | 505200200 | 6 | 8 | 57,30 |
| 200 x 3" | 505200300 | 6 | 8 | 58,84 |
| 200 x 4" | 505200400 | 6 | 8 | 58,84 |
| 225 x 1 1/4" | 505225114 | 4 | 7 | 68,52 |
| 225 x 1 1/2" | 505225112 | 4 | 7 | 68,52 |
| 225 x 2" | 505225200 | 4 | 7 | 68,52 |
| 225 x 3" | 505225300 | 4 | 7 | 68,52 |
| 225 x 4" | 505225400 | 4 | 7 | 71,10 |
| 250 x 1 1/4" | 505250114 | 4 | 7 | 80,80 |
| 250 x 1 1/2" | 505250112 | 4 | 7 | 80,80 |
| 250 x 2" | 505250200 | 4 | 7 | 80,80 |
| 250 x 3" | 505250300 | 4 | 7 | 82,74 |
| 250 x 4" | 505250400 | 4 | 6 | 82,74 |
| 280 x 1 1/4" | 505280114 | 4 | 3 | 98,64 |
| 280 x 1 1/2" | 505280112 | 4 | 3 | 98,64 |
| 280 x 2" | 505280200 | 4 | 3 | 98,64 |
| 280 x 3" | 505280300 | 4 | 3 | 98,64 |
| 280 x 4" | 505280400 | 4 | 3 | 98,64 |
| 315 x 1 1/4" | 505315114 | 4 | 4 | 101,48 |
| 315 x 1 1/2" | 505315112 | 4 | 4 | 101,48 |
| 315 x 2" | 505315200 | 4 | 4 | 101,48 |
| 315 x 3" | 505315300 | 4 | 4 | 105,36 |
| 315 x 4" | 505315400 | 4 | 4 | 105,36 |

Collarín en PP con anillo de refuerzo en inox.
Para riego y obra civil.



508

| d x Rh x Rh | Ref. | €NBR |
|-----------------------|-----------|-------|
| 20 x 1/2" x 1/2" | 508020012 | 2,98 |
| 25 x 1/2" x 1/2" | 508025012 | 3,20 |
| 25 x 3/4" x 3/4" | 508025034 | 3,20 |
| 32 x 1/2" x 1/2" | 508032012 | 3,96 |
| 32 x 3/4" x 3/4" | 508032034 | 3,96 |
| 32 x 1" x 1" | 508032100 | 4,08 |
| 40 x 1/2" x 1/2" | 508040012 | 4,66 |
| 40 x 3/4" x 3/4" | 508040034 | 4,66 |
| 40 x 1" x 1" | 508040100 | 4,66 |
| 50 x 1/2" x 1/2" | 508050012 | 5,14 |
| 50 x 3/4" x 3/4" | 508050034 | 5,14 |
| 50 x 1" x 1" | 508050100 | 5,14 |
| 63 x 1/2" x 1/2" | 508063012 | 6,18 |
| 63 x 3/4" x 3/4" | 508063034 | 6,18 |
| 63 x 1" x 1" | 508063100 | 6,18 |
| 63 x 1 1/4" x 1 1/4" | 508063114 | 6,18 |
| 63 x 1 1/2" x 1 1/2" | 508063112 | 6,18 |
| 75 x 1/2" x 1/2" | 508075012 | 8,12 |
| 75 x 3/4" x 3/4" | 508075034 | 8,12 |
| 75 x 1" x 1" | 508075100 | 8,12 |
| 75 x 1 1/4" x 1 1/4" | 508075114 | 8,12 |
| 75 x 1 1/2" x 1 1/2" | 508075112 | 8,12 |
| 75 x 2" x 2" | 508075200 | 8,12 |
| 90 x 1/2" x 1/2" | 508090012 | 10,88 |
| 90 x 3/4" x 3/4" | 508090034 | 10,88 |
| 90 x 1" x 1" | 508090100 | 10,88 |
| 90 x 1 1/4" x 1 1/4" | 508090114 | 10,88 |
| 90 x 1 1/2" x 1 1/2" | 508090112 | 10,88 |
| 90 x 2" x 2" | 508090200 | 10,88 |
| 110 x 1/2" x 1/2" | 508110012 | 11,70 |
| 110 x 3/4" x 3/4" | 508110034 | 11,70 |
| 110 x 1" x 1" | 508110100 | 11,70 |
| 110 x 1 1/4" x 1 1/4" | 508110114 | 11,70 |
| 110 x 1 1/2" x 1 1/2" | 508110112 | 11,70 |
| 110 x 2" x 2" | 508110200 | 11,70 |
| 110 x 3" x 3" | 508110300 | 27,44 |

| d x Rh x Rh | Ref. | €NBR |
|-----------------------|-----------|--------|
| 125 x 3/4" x 3/4" | 508125034 | 16,68 |
| 125 x 1" x 1" | 508125100 | 16,68 |
| 125 x 1 1/4" x 1 1/4" | 508125114 | 16,68 |
| 125 x 1 1/2" x 1 1/2" | 508125112 | 16,68 |
| 125 x 2" x 2" | 508125200 | 16,68 |
| 140 x 1" | 508140100 | 21,86 |
| 140 x 1 1/4" | 508140114 | 21,86 |
| 140 x 1 1/2" | 508140112 | 21,86 |
| 140 x 2" | 508140200 | 21,86 |
| 140 x 2 1/2" | 508140212 | 28,06 |
| 140 x 3" | 508140300 | 28,06 |
| 160 x 1" x 1" | 508160100 | 28,98 |
| 160 x 1 1/4" x 1 1/4" | 508160114 | 28,98 |
| 160 x 1 1/2" x 1 1/2" | 508160112 | 28,98 |
| 160 x 2" x 2" | 508160200 | 28,98 |
| 160 x 3" x 3" | 508160300 | 39,46 |
| 180 x 1 1/4" x 1 1/4" | 508180114 | 119,10 |
| 180 x 2" x 2" | 508180200 | 119,10 |
| 200 x 1 1/4" x 1 1/4" | 508200114 | 108,16 |
| 200 x 1 1/2" x 1 1/2" | 508200112 | 108,16 |
| 200 x 2" x 2" | 508200200 | 108,16 |
| 200 x 3" x 3" | 508200300 | 113,52 |
| 200 x 4" x 4" | 508200400 | 113,52 |
| 225 x 1 1/4" x 1 1/4" | 508225114 | 123,82 |
| 225 x 1 1/2" x 1 1/2" | 508225112 | 123,82 |
| 225 x 2" x 2" | 508225200 | 123,82 |
| 225 x 3" x 3" | 508225300 | 132,30 |
| 225 x 4" x 4" | 508225400 | 132,30 |
| 250 x 1 1/4" x 1 1/4" | 508250114 | 169,66 |
| 250 x 1 1/2" x 1 1/2" | 508250112 | 169,66 |
| 250 x 2" x 2" | 508250200 | 169,66 |
| 250 x 3" x 3" | 508250300 | 178,14 |
| 250 x 4" x 4" | 508250400 | 178,14 |
| 315 x 1 1/4" x 1 1/4" | 508315114 | 226,60 |
| 315 x 1 1/2" x 1 1/2" | 508315112 | 226,60 |
| 315 x 2" x 2" | 508315200 | 226,60 |
| 315 x 3" x 3" | 508315300 | 236,12 |
| 315 x 4" x 4" | 508315400 | 236,12 |

Collarín en PP con anillo de refuerzo en inox.
Para riego y obra civil.



Válvulas manuales de PVC-U presión

Válvulas de bola 2 vías



420*

| d | Ref. | DN | PN | U/ | € EPDM |
|----|--------------|----|----|----|--------|
| 16 | 1V42001600 | 10 | 16 | 90 | 9,33 |
| 20 | 1V42002000 ● | 15 | 16 | 90 | 10,28 |
| 25 | 1V42002500 | 20 | 16 | 60 | 12,09 |
| 32 | 1V42003200 | 25 | 16 | 40 | 14,33 |
| 40 | 1V42004000 | 32 | 16 | 22 | 18,49 |
| 50 | 1V42005000 ● | 40 | 16 | 15 | 23,46 |
| 63 | 1V42006300 ● | 50 | 16 | 8 | 29,24 |

Válvula de bola maneta azul.

H-H encolar. Junta EPDM - Asiento PE. Bidireccional.



420*

| d | Ref. | DN | PN | U/ | € EPDM |
|-----|--------------|-----|----|----|--------|
| 75 | 1V42007500 | 65 | 10 | 3 | 99,33 |
| 90 | 1V42009000 ● | 80 | 10 | 3 | 135,16 |
| 110 | 1V42011000 | 100 | 10 | 2 | 241,61 |

Válvula de bola maneta azul.

H-H encolar. Junta EPDM - Asiento PE. Bidireccional.



421*

| Rh | Ref. | DN | PN | U/ | € EPDM |
|--------|--------------|----|----|----|--------|
| 3/8" | 1V42101600 | 10 | 16 | 90 | 10,54 |
| 1/2" | 1V42102000 | 15 | 16 | 90 | 11,61 |
| 3/4" | 1V42102500 | 20 | 16 | 60 | 13,68 |
| 1" | 1V42103200 ● | 25 | 16 | 40 | 16,19 |
| 1 1/4" | 1V42104000 ● | 32 | 16 | 22 | 20,90 |
| 1 1/2" | 1V42105000 ● | 40 | 16 | 15 | 26,49 |
| 2" | 1V42106300 ● | 50 | 16 | 8 | 33,03 |

Válvula de bola maneta azul.

H-H roscar. Junta EPDM - Asiento PE. Bidireccional.



421*

| Rh | Ref. | DN | PN | U/ | € EPDM |
|--------|------------|-----|----|----|--------|
| 2 1/2" | 1V42107500 | 65 | 10 | 3 | 104,36 |
| 3" | 1V42109000 | 80 | 10 | 3 | 140,49 |
| 4" | 1V42111000 | 100 | 10 | 2 | 236,90 |

Válvula de bola maneta azul.

H-H roscar. Junta EPDM - Asiento PE. Bidireccional.



Accesorios manipulados de Polietileno

INFRAESTRUCTURA





Ideales para grandes obras de polietileno en exterior

Diseño y fabricación de accesorios de polietileno a medida

Aliaxis cuenta con un taller renovado dedicado exclusivamente al diseño y fabricación de uniones a medida en polietileno, para proyectos integrales. Así como un equipo experto que ofrece la máxima versatilidad en nuestras uniones a través de soldadura a tope, para obtener cualquiera que sea la forma que el proyecto necesite.

Con este taller renovado, ampliamos nuestra capacidad para fabricar proyectos en polietileno de hasta diámetro 1.000 mm, pudiendo así atender las necesidades específicas del cliente con soluciones a medida.



Características

- Accesorios standard y a medida
- Fabricación propia bajo exigentes controles de calidad
- Reducción de presión de cada tipo de accesorio (opcional), dando la posibilidad a fabricarlos reforzados bajo demanda
- Disponibles en PE 40 y PE 100
- Tamaños desde los 63 mm hasta los 1000 mm.
- Disponible en SDR estándar 17/11/26 (otros SDR están disponibles bajo pedido)
- En cumplimiento de EN12201

Beneficios

- Resistente a la corrosión
- Baja fricción y alta tasa de flujo
- Apto para varias técnicas de instalación
- Ahorro en transporte e instalación
- Seguridad de suministro continuo
- Reducción de la huella de carbono

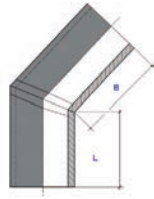

SDR 11

CODO 30° SEGMENTADO

| Ref. | Ø | €/Ud. |
|--------------|-----|--------|
| 089063030160 | 63 | 24,29 |
| 089075030160 | 75 | 28,04 |
| 089090030160 | 90 | 31,65 |
| 089110030160 | 110 | 36,81 |
| 089125030160 | 125 | 44,81 |
| 089140030160 | 140 | 50,18 |
| 089160030160 | 160 | 61,18 |
| 089180030160 | 180 | 69,79 |
| 089200030160 | 200 | 79,27 |
| 089225030160 | 225 | 103,84 |
| 089250030160 | 250 | 120,48 |
| 089280030160 | 280 | 153,49 |
| 089315030160 | 315 | 194,68 |
| 089355030160 | 355 | 268,66 |
| 089400030160 | 400 | 366,81 |
| 089450030160 | 450 | 475,40 |
| 089500030160 | 500 | 634,61 |
| 089560030160 | 560 | 732,04 |
| 089630030160 | 630 | 952,51 |

SDR 17

CODOS 30° SEGMENTADO

| Ref. | Ø | €/Ud. |
|--------------|------|----------|
| 089063030100 | 63 | 19,63 |
| 089075030100 | 75 | 24,35 |
| 089090030100 | 90 | 26,83 |
| 089110030100 | 110 | 30,52 |
| 089125030100 | 125 | 35,76 |
| 089140030100 | 140 | 39,63 |
| 089160030100 | 160 | 47,97 |
| 089180030100 | 180 | 53,98 |
| 089200030100 | 200 | 60,53 |
| 089225030100 | 225 | 77,34 |
| 089250030100 | 250 | 88,61 |
| 089280030100 | 280 | 111,21 |
| 089315030100 | 315 | 139,34 |
| 089355030100 | 355 | 190,92 |
| 089400030100 | 400 | 256,87 |
| 089450030100 | 450 | 340,44 |
| 089500030100 | 500 | 450,31 |
| 089560030100 | 560 | 517,73 |
| 089630030100 | 630 | 664,28 |
| 089710030100 | 710 | 937,82 |
| 089800030100 | 800 | 1.233,10 |
| 089900030100 | 900 | 1.734,57 |
| 089100030100 | 1000 | 2.255,39 |

**SDR 11****CODO 45° SEGMENTADO**

| Ref. | Ø | €/Ud. |
|--------------|-----|----------|
| 089063045160 | 63 | 43,02 |
| 089075045160 | 75 | 50,67 |
| 089090045160 | 90 | 56,56 |
| 089110045160 | 110 | 64,71 |
| 089125045160 | 125 | 73,53 |
| 089140045160 | 140 | 84,52 |
| 089160045160 | 160 | 97,08 |
| 089180045160 | 180 | 113,51 |
| 089200045160 | 200 | 129,23 |
| 089225045160 | 225 | 154,49 |
| 089250045160 | 250 | 182,83 |
| 089280045160 | 280 | 233,19 |
| 089315045160 | 315 | 290,35 |
| 089355045160 | 355 | 388,93 |
| 089400045160 | 400 | 482,51 |
| 089450045160 | 450 | 604,87 |
| 089500045160 | 500 | 795,99 |
| 089560045160 | 560 | 920,89 |
| 089630045160 | 630 | 1.204,86 |

SDR 17**CODO 45° SEGMENTADO**

| Ref. | Ø | €/Ud. |
|--------------|------|----------|
| 089063045100 | 63 | 35,43 |
| 089075045100 | 75 | 43,11 |
| 089090045100 | 90 | 48,18 |
| 089110045100 | 110 | 54,00 |
| 089125045100 | 125 | 61,60 |
| 089140045100 | 140 | 67,44 |
| 089160045100 | 160 | 81,35 |
| 089180045100 | 180 | 90,25 |
| 089200045100 | 200 | 99,87 |
| 089225045100 | 225 | 123,39 |
| 089250045100 | 250 | 139,43 |
| 089280045100 | 280 | 170,85 |
| 089315045100 | 315 | 209,87 |
| 089355045100 | 355 | 284,76 |
| 089400045100 | 400 | 357,29 |
| 089450045100 | 450 | 440,69 |
| 089500045100 | 500 | 573,78 |
| 089560045100 | 560 | 661,38 |
| 089630045100 | 630 | 828,34 |
| 089710045100 | 710 | 1.157,16 |
| 089800045100 | 800 | 1.610,90 |
| 089900045100 | 900 | 2.154,42 |
| 089100045100 | 1000 | 2.944,99 |

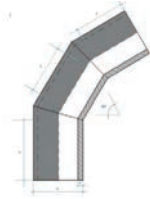

SDR 11

CODO 60° SEGMENTADO

| Ref. | Ø | €/Ud. |
|--------------|-----|----------|
| 089063060160 | 63 | 43,02 |
| 089075060160 | 75 | 50,67 |
| 089090060160 | 90 | 56,56 |
| 089110060160 | 110 | 64,71 |
| 089125060160 | 125 | 75,36 |
| 089140060160 | 140 | 84,52 |
| 089160060160 | 160 | 100,90 |
| 089180060160 | 180 | 115,28 |
| 089200060160 | 200 | 129,23 |
| 089225060160 | 225 | 163,57 |
| 089250060160 | 250 | 187,31 |
| 089280060160 | 280 | 233,19 |
| 089315060160 | 315 | 290,28 |
| 089355060160 | 355 | 397,04 |
| 089400060160 | 400 | 526,54 |
| 089450060160 | 450 | 677,40 |
| 089500060160 | 500 | 895,07 |
| 089560060160 | 560 | 1.047,00 |
| 089630060160 | 630 | 1.371,52 |

SDR 17

CODO 60° SEGMENTADO

| Ref. | Ø | €/Ud. |
|--------------|------|----------|
| 089063060100 | 63 | 35,43 |
| 089075060100 | 75 | 43,24 |
| 089090060100 | 90 | 48,18 |
| 089110060100 | 110 | 54,00 |
| 089125060100 | 125 | 61,60 |
| 089140060100 | 140 | 67,44 |
| 089160060100 | 160 | 81,35 |
| 089180060100 | 180 | 90,25 |
| 089200060100 | 200 | 99,87 |
| 089225060100 | 225 | 123,39 |
| 089250060100 | 250 | 139,43 |
| 089280060100 | 280 | 170,85 |
| 089315060100 | 315 | 209,82 |
| 089355060100 | 355 | 284,76 |
| 089400060100 | 400 | 371,68 |
| 089450060100 | 450 | 489,70 |
| 089500060100 | 500 | 640,88 |
| 089560060100 | 560 | 747,38 |
| 089630060100 | 630 | 973,46 |
| 089710060100 | 710 | 1.396,40 |
| 089800060100 | 800 | 1.858,40 |
| 089900060100 | 900 | 2.642,34 |
| 089100060100 | 1000 | 3.473,45 |

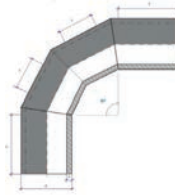

SDR 11

CODO 90° SEGMENTADO

| Ref. | Ø | €/Ud. |
|--------------|-----|----------|
| 089063090160 | 63 | 61,48 |
| 089075090160 | 75 | 72,19 |
| 089090090160 | 90 | 81,12 |
| 089110090160 | 110 | 92,10 |
| 089125090160 | 125 | 105,23 |
| 089140090160 | 140 | 117,75 |
| 089160090160 | 160 | 142,33 |
| 089180090160 | 180 | 158,96 |
| 089200090160 | 200 | 176,95 |
| 089225090160 | 225 | 219,76 |
| 089250090160 | 250 | 249,78 |
| 089280090160 | 280 | 306,76 |
| 089315090160 | 315 | 377,43 |
| 089355090160 | 355 | 509,90 |
| 089400090160 | 400 | 668,36 |
| 089450090160 | 450 | 879,72 |
| 089500090160 | 500 | 1.164,04 |
| 089560090160 | 560 | 1.359,22 |
| 089630090160 | 630 | 1.793,21 |

SDR 17

CODO 90° SEGMENTADO

| Ref. | Ø | €/Ud. |
|--------------|------|----------|
| 089063090100 | 63 | 51,09 |
| 089075090100 | 75 | 61,44 |
| 089090090100 | 90 | 69,29 |
| 089110090100 | 110 | 77,12 |
| 089125090100 | 125 | 86,84 |
| 089140090100 | 140 | 94,50 |
| 089160090100 | 160 | 113,76 |
| 089180090100 | 180 | 125,30 |
| 089200090100 | 200 | 137,70 |
| 089225090100 | 225 | 167,05 |
| 089250090100 | 250 | 187,30 |
| 089280090100 | 280 | 226,34 |
| 089315090100 | 315 | 274,60 |
| 089355090100 | 355 | 368,14 |
| 089400090100 | 400 | 474,39 |
| 089450090100 | 450 | 627,24 |
| 089500090100 | 500 | 811,63 |
| 089560090100 | 560 | 972,28 |
| 089630090100 | 630 | 1.275,79 |
| 089710090100 | 710 | 1.702,00 |
| 089800090100 | 800 | 2.275,86 |
| 089900090100 | 900 | 3.221,67 |
| 089100090100 | 1000 | 4.313,35 |

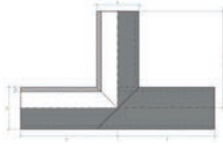

SDR 11

TE IGUAL SEGMENTADA

| Ref. | Ø | €/Ud. |
|--------------|-----|----------|
| 100063000160 | 63 | 58,39 |
| 100075000160 | 75 | 66,35 |
| 100090000160 | 90 | 75,16 |
| 100110000160 | 110 | 87,89 |
| 100125000160 | 125 | 98,50 |
| 100140000160 | 140 | 109,56 |
| 100160000160 | 160 | 132,28 |
| 100180000160 | 180 | 149,89 |
| 100200000160 | 200 | 169,17 |
| 100225000160 | 225 | 225,50 |
| 100250000160 | 250 | 260,65 |
| 100280000160 | 280 | 330,68 |
| 100315000160 | 315 | 457,72 |
| 100355000160 | 355 | 562,41 |
| 100400000160 | 400 | 751,41 |
| 100450000160 | 450 | 947,59 |
| 100500000160 | 500 | 1.262,66 |
| 100560000160 | 560 | 1.464,94 |
| 100630000160 | 630 | 1.893,89 |

SDR 17

TE IGUAL SEGMENTADA

| Ref. | Ø | €/Ud. |
|--------------|------|----------|
| 100063000100 | 63 | 47,36 |
| 100075000100 | 75 | 57,96 |
| 100090000100 | 90 | 64,15 |
| 100110000100 | 110 | 73,36 |
| 100125000100 | 125 | 80,29 |
| 100140000100 | 140 | 88,39 |
| 100160000100 | 160 | 105,83 |
| 100180000100 | 180 | 118,30 |
| 100200000100 | 200 | 131,81 |
| 100225000100 | 225 | 170,52 |
| 100250000100 | 250 | 194,55 |
| 100280000100 | 280 | 242,76 |
| 100315000100 | 315 | 329,54 |
| 100355000100 | 355 | 403,92 |
| 100400000100 | 400 | 548,26 |
| 100450000100 | 450 | 681,89 |
| 100500000100 | 500 | 900,84 |
| 100560000100 | 560 | 1.043,83 |
| 100630000100 | 630 | 1.343,88 |
| 100710000100 | 710 | 1.927,15 |
| 100800000100 | 800 | 2.524,99 |
| 100900000100 | 900 | 3.353,08 |
| 100100000100 | 1000 | 4.295,37 |

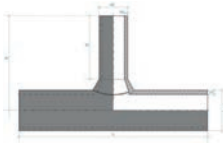

SDR 11

TE REDUCIDA

| Ref. | Ø | €/Ud. |
|--------------|---------|--------|
| 105075063160 | 75/63 | 84,07 |
| 105090063160 | 90/63 | 87,16 |
| 105090075160 | 90/75 | 93,91 |
| 105110063160 | 110/63 | 92,25 |
| 105110075160 | 110/75 | 99,00 |
| 105110090160 | 110/90 | 101,41 |
| 105125063160 | 125/63 | 97,14 |
| 105125075160 | 125/75 | 103,89 |
| 105125090160 | 125/90 | 106,30 |
| 105125090160 | 125/110 | 106,30 |
| 105140063160 | 140/63 | 102,01 |
| 105140075160 | 140/75 | 144,75 |

| Ref. | Ø | €/Ud. |
|--------------|---------|--------|
| 105140090160 | 140/90 | 147,17 |
| 105140110160 | 140/110 | 150,53 |
| 105140125160 | 140/125 | 198,60 |
| 105160063160 | 160/63 | 128,38 |
| 105160075160 | 160/75 | 134,33 |
| 105160090160 | 160/90 | 136,46 |
| 105160110160 | 160/110 | 139,42 |
| 105160125160 | 160/125 | 163,23 |
| 105160140160 | 160/140 | 166,08 |
| 105180063160 | 180/63 | 135,62 |
| 105180075160 | 180/75 | 141,57 |
| 105180090160 | 180/90 | 143,70 |

| Ref. | Ø | €/Ud. |
|--------------|---------|--------|
| 105180110160 | 180/110 | 146,67 |
| 105180125160 | 180/125 | 156,16 |
| 105180140160 | 180/140 | 174,29 |
| 105180160160 | 180/160 | 233,61 |
| 105200063160 | 200/63 | 143,84 |
| 105200075160 | 200/75 | 149,79 |
| 105200090160 | 200/90 | 151,93 |
| 105200110160 | 200/110 | 154,89 |
| 105200125160 | 200/125 | 169,38 |
| 105200140160 | 200/140 | 219,62 |
| 105200160160 | 200/160 | 262,34 |
| 105200180160 | 200/180 | 262,37 |
| 105225063160 | 225/63 | 186,98 |
| 105225075160 | 225/75 | 192,93 |
| 105225090160 | 225/90 | 195,06 |
| 105225110160 | 225/110 | 198,03 |
| 105225125160 | 225/125 | 202,63 |
| 105225140160 | 225/140 | 268,50 |
| 105225160160 | 225/160 | 275,22 |
| 105225180160 | 225/180 | 279,70 |
| 105225200160 | 225/200 | 286,96 |
| 105250063160 | 250/63 | 199,71 |
| 105250075160 | 250/75 | 205,66 |
| 105250090160 | 250/90 | 207,79 |
| 105250110160 | 250/110 | 178,13 |
| 105250125160 | 250/125 | 217,37 |
| 105250140160 | 250/140 | 288,52 |
| 105250160160 | 250/160 | 260,93 |
| 105250180160 | 250/180 | 300,73 |
| 105250200160 | 250/200 | 308,59 |
| 105250225160 | 250/225 | 381,91 |
| 105280063160 | 280/63 | 248,58 |
| 105280075160 | 280/75 | 254,53 |
| 105280090160 | 280/90 | 256,66 |
| 105280110160 | 280/110 | 260,15 |
| 105280125160 | 280/125 | 340,50 |
| 105280140160 | 280/140 | 344,91 |
| 105280160160 | 280/160 | 310,69 |
| 105280180160 | 280/180 | 321,12 |
| 105280200160 | 280/200 | 364,99 |
| 105280225160 | 280/225 | 375,54 |
| 105280250160 | 280/250 | 384,15 |
| 105315063160 | 315/63 | 271,97 |
| 105315075160 | 315/75 | 277,92 |
| 105315090160 | 315/90 | 316,04 |
| 105315110160 | 315/110 | 351,65 |
| 105315125160 | 315/125 | 405,63 |
| 105315140160 | 315/140 | 372,78 |
| 105315160160 | 315/160 | 303,51 |
| 105315180160 | 315/180 | 385,00 |
| 105315200160 | 315/200 | 536,88 |
| 105315225160 | 315/225 | 599,10 |
| 105315250160 | 315/250 | 599,10 |
| 105315280160 | 315/280 | 629,84 |
| 105355063160 | 355/63 | 346,67 |
| 105355075160 | 355/75 | 338,13 |

| Ref. | Ø | €/Ud. |
|--------------|---------|----------|
| 105355090160 | 355/90 | 377,37 |
| 105355110160 | 355/110 | 381,22 |
| 105355125160 | 355/125 | 403,55 |
| 105355140160 | 355/140 | 442,72 |
| 105355160160 | 355/160 | 396,99 |
| 105355180160 | 355/180 | 490,94 |
| 105355200160 | 355/200 | 501,37 |
| 105355225160 | 355/225 | 509,36 |
| 105355250160 | 355/250 | 508,14 |
| 105355280160 | 355/280 | 944,61 |
| 105355315160 | 355/315 | 662,45 |
| 105400063160 | 400/63 | 400,47 |
| 105400075160 | 400/75 | 406,42 |
| 105400090160 | 400/90 | 415,33 |
| 105400110160 | 400/110 | 450,95 |
| 105400125160 | 400/125 | 519,13 |
| 105400140160 | 400/140 | 558,30 |
| 105400160160 | 400/160 | 562,51 |
| 105400180160 | 400/180 | 642,52 |
| 105400200160 | 400/200 | 652,95 |
| 105400225160 | 400/225 | 732,95 |
| 105400250160 | 400/250 | 741,56 |
| 105400280160 | 400/280 | 810,39 |
| 105400315160 | 400/315 | 1.015,69 |
| 105400355160 | 400/355 | 1.124,62 |
| 105450063160 | 450/63 | 448,26 |
| 105450075160 | 450/75 | 454,21 |
| 105450090160 | 450/90 | 467,91 |
| 105450110160 | 450/110 | 535,30 |
| 105450125160 | 450/125 | 684,17 |
| 105450140160 | 450/140 | 723,34 |
| 105450160160 | 450/160 | 676,37 |
| 105450180160 | 450/180 | 771,56 |
| 105450200160 | 450/200 | 781,99 |
| 105450225160 | 450/225 | 789,98 |
| 105450250160 | 450/250 | 834,64 |
| 105450280160 | 450/280 | 849,66 |
| 105450315160 | 450/315 | 897,53 |
| 105450355160 | 450/355 | 1.505,76 |
| 105450400160 | 450/400 | 1.393,32 |
| 105500063160 | 500/63 | 531,17 |
| 105500075160 | 500/75 | 537,12 |
| 105500090160 | 500/90 | 585,29 |
| 105500110160 | 500/110 | 589,14 |
| 105500125160 | 500/125 | 673,18 |
| 105500140160 | 500/140 | 748,35 |
| 105500160160 | 500/160 | 666,67 |
| 105500180160 | 500/180 | 760,57 |
| 105500200160 | 500/200 | 698,99 |
| 105500225160 | 500/225 | 778,98 |
| 105500250160 | 500/250 | 832,07 |
| 105500280160 | 500/280 | 847,09 |
| 105500315160 | 500/315 | 902,61 |
| 105500355160 | 500/355 | 2.055,87 |
| 105500400160 | 500/400 | 1.906,49 |
| 105500450160 | 500/450 | 1.865,59 |

| Ref. | Ø | €/Ud. |
|--------------|---------|----------|
| 105560063160 | 560/63 | 611,46 |
| 105560075160 | 560/75 | 617,36 |
| 105560090160 | 560/90 | 651,43 |
| 105560110160 | 560/110 | 686,45 |
| 105560125160 | 560/125 | 783,47 |
| 105560140160 | 560/140 | 858,65 |
| 105560160160 | 560/160 | 765,81 |
| 105560180160 | 560/180 | 837,46 |
| 105560200160 | 560/200 | 828,65 |
| 105560225160 | 560/225 | 908,82 |
| 105560250160 | 560/250 | 967,37 |
| 105560280160 | 560/280 | 981,39 |
| 105560315160 | 560/315 | 1.079,08 |
| 105560355160 | 560/355 | 2.486,83 |
| 105560400160 | 560/400 | 2.734,30 |
| 105560450160 | 560/450 | 2.245,83 |
| 105560500160 | 560/500 | 2.157,38 |
| 105630063160 | 630/63 | 699,49 |

| Ref. | Ø | €/Ud. |
|--------------|---------|----------|
| 105630075160 | 630/75 | 716,26 |
| 105630090160 | 630/90 | 739,46 |
| 105630110160 | 630/110 | 774,48 |
| 105630125160 | 630/125 | 883,24 |
| 105630140160 | 630/140 | 958,41 |
| 105630160160 | 630/160 | 914,30 |
| 105630180160 | 630/180 | 1.039,93 |
| 105630200160 | 630/200 | 1.004,49 |
| 105630225160 | 630/225 | 1.084,66 |
| 105630250160 | 630/250 | 1.093,45 |
| 105630280160 | 630/280 | 1.169,76 |
| 105630315160 | 630/315 | 1.317,40 |
| 105630355160 | 630/355 | 3.589,15 |
| 105630400160 | 630/400 | 4.010,13 |
| 105630450160 | 630/450 | 3.575,96 |
| 105630500160 | 630/500 | 3.025,24 |
| 105630560160 | 630/560 | 2.824,24 |

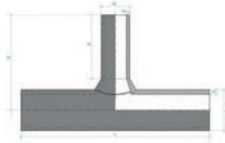

SDR 17

TE REDUCIDA

| Ref. | Ø | €/Ud. |
|--------------|---------|--------|
| 105125063100 | 125/63 | 68,25 |
| 105125110100 | 125/110 | 189,78 |
| 105160090100 | 160/90 | 88,46 |
| 105180140100 | 180/140 | 155,21 |
| 105200090100 | 200/90 | 122,30 |
| 105200110100 | 200/110 | 132,38 |
| 105250063100 | 250/63 | 175,38 |
| 105250075100 | 250/75 | 181,75 |
| 105250090100 | 250/90 | 157,48 |
| 105250110100 | 250/110 | 163,31 |
| 105250125100 | 250/125 | 201,61 |
| 105250140100 | 250/140 | 233,40 |
| 105250160100 | 250/160 | 213,64 |
| 105250180100 | 250/180 | 249,17 |
| 105250200100 | 250/200 | 271,11 |
| 105250225100 | 250/225 | 333,86 |
| 105280063100 | 280/63 | 151,81 |
| 105280075100 | 280/75 | 193,46 |
| 105280090100 | 280/90 | 193,34 |
| 105280110100 | 280/110 | 229,11 |
| 105280125100 | 280/125 | 234,34 |
| 105280140100 | 280/140 | 269,91 |
| 105280160100 | 280/160 | 243,08 |
| 105280180100 | 280/180 | 278,94 |
| 105280200100 | 280/200 | 285,08 |
| 105280225100 | 280/225 | 292,30 |
| 105280250100 | 280/250 | 298,08 |
| 105315063100 | 315/63 | 203,22 |
| 105315075100 | 315/75 | 209,59 |
| 105315090100 | 315/90 | 213,87 |

| Ref. | Ø | €/Ud. |
|--------------|---------|--------|
| 105315110100 | 315/110 | 216,56 |
| 105315125100 | 315/125 | 206,41 |
| 105315140100 | 315/140 | 289,11 |
| 105315160100 | 315/160 | 257,24 |
| 105315180100 | 315/180 | 370,16 |
| 105315200100 | 315/200 | 412,29 |
| 105315225100 | 315/225 | 479,57 |
| 105315250100 | 315/250 | 518,09 |
| 105315280100 | 315/280 | 561,91 |
| 105355063100 | 355/63 | 254,53 |
| 105355075100 | 355/75 | 260,91 |
| 105355090100 | 355/90 | 265,96 |
| 105355110100 | 355/110 | 245,37 |
| 105355125100 | 355/125 | 346,16 |
| 105355140100 | 355/140 | 348,43 |
| 105355160100 | 355/160 | 312,36 |
| 105355180100 | 355/180 | 357,46 |
| 105355200100 | 355/200 | 401,34 |
| 105355225100 | 355/225 | 442,83 |
| 105355250100 | 355/250 | 448,61 |
| 105355280100 | 355/280 | 755,79 |
| 105355315100 | 355/315 | 712,95 |
| 105400063100 | 400/63 | 232,05 |
| 105400075100 | 400/75 | 285,40 |
| 105400090100 | 400/90 | 292,55 |
| 105400110100 | 400/110 | 303,69 |
| 105400125100 | 400/125 | 262,92 |
| 105400140100 | 400/140 | 377,64 |
| 105400160100 | 400/160 | 369,90 |
| 105400180100 | 400/180 | 355,10 |

| Ref. | Ø | €/Ud. |
|--------------|---------|----------|
| 105400200100 | 400/200 | 430,55 |
| 105400225100 | 400/225 | 616,06 |
| 105400250100 | 400/250 | 620,01 |
| 105400280100 | 400/280 | 648,04 |
| 105400315100 | 400/315 | 655,45 |
| 105400355100 | 400/355 | 909,47 |
| 105450063100 | 450/63 | 311,46 |
| 105450075100 | 450/75 | 331,37 |
| 105450090100 | 450/90 | 292,10 |
| 105450110100 | 450/110 | 343,93 |
| 105450125100 | 450/125 | 385,97 |
| 105450140100 | 450/140 | 560,34 |
| 105450160100 | 450/160 | 447,44 |
| 105450180100 | 450/180 | 605,39 |
| 105450200100 | 450/200 | 541,25 |
| 105450225100 | 450/225 | 474,72 |
| 105450250100 | 450/250 | 576,86 |
| 105450280100 | 450/280 | 587,90 |
| 105450315100 | 450/315 | 620,33 |
| 105450355100 | 450/355 | 1.209,60 |
| 105450400100 | 450/400 | 1.123,94 |
| 105500063100 | 500/63 | 294,26 |
| 105500075100 | 500/75 | 387,84 |
| 105500090100 | 500/90 | 341,70 |
| 105500110100 | 500/110 | 396,15 |
| 105500125100 | 500/125 | 527,88 |
| 105500140100 | 500/140 | 566,15 |
| 105500160100 | 500/160 | 568,00 |
| 105500180100 | 500/180 | 458,35 |
| 105500200100 | 500/200 | 511,05 |
| 105500225100 | 500/225 | 588,54 |
| 105500250100 | 500/250 | 508,95 |
| 105500280100 | 500/280 | 635,46 |
| 105500315100 | 500/315 | 673,11 |
| 105500355100 | 500/355 | 1.662,81 |
| 105500400100 | 500/400 | 1.533,88 |
| 105500450100 | 500/450 | 1.473,51 |
| 105560063100 | 560/63 | 432,49 |
| 105560075100 | 560/75 | 438,94 |
| 105560090100 | 560/90 | 472,26 |
| 105560110100 | 560/110 | 442,63 |
| 105560125100 | 560/125 | 650,15 |
| 105560140100 | 560/140 | 652,41 |
| 105560160100 | 560/160 | 645,35 |
| 105560180100 | 560/180 | 530,66 |
| 105560200100 | 560/200 | 473,61 |
| 105560225100 | 560/225 | 712,36 |
| 105560250100 | 560/250 | 751,91 |
| 105560280100 | 560/280 | 762,28 |
| 105560315100 | 560/315 | 828,42 |
| 105560355100 | 560/355 | 2.008,70 |
| 105560400100 | 560/400 | 1.895,00 |
| 105560450100 | 560/450 | 1.752,20 |
| 105560500100 | 560/500 | 1.664,36 |
| 105630063100 | 630/63 | 492,37 |
| 105630075100 | 630/75 | 362,06 |

| Ref. | Ø | €/Ud. |
|--------------|---------|----------|
| 105630090100 | 630/90 | 401,11 |
| 105630110100 | 630/110 | 533,66 |
| 105630125100 | 630/125 | 646,00 |
| 105630140100 | 630/140 | 452,30 |
| 105630160100 | 630/160 | 650,82 |
| 105630180100 | 630/180 | 529,02 |
| 105630200100 | 630/200 | 754,10 |
| 105630225100 | 630/225 | 651,68 |
| 105630250100 | 630/250 | 607,56 |
| 105630280100 | 630/280 | 890,12 |
| 105630315100 | 630/315 | 990,07 |
| 105630355100 | 630/355 | 2.972,08 |
| 105630400100 | 630/400 | 2.429,96 |
| 105630450100 | 630/450 | 2.245,90 |
| 105630500100 | 630/500 | 2.136,14 |
| 105630560100 | 630/560 | 1.966,30 |
| 105710063100 | 710/63 | 603,82 |
| 105710075100 | 710/75 | 610,27 |
| 105710090100 | 710/90 | 643,59 |
| 105710110100 | 710/110 | 590,79 |
| 105710125100 | 710/125 | 772,32 |
| 105710140100 | 710/140 | 774,58 |
| 105710160100 | 710/160 | 721,38 |
| 105710180100 | 710/180 | 821,38 |
| 105710200100 | 710/200 | 850,73 |
| 105710225100 | 710/225 | 892,33 |
| 105710250100 | 710/250 | 987,70 |
| 105710280100 | 710/280 | 1.034,07 |
| 105710315100 | 710/315 | 1.129,94 |
| 105710355100 | 710/355 | 4.432,41 |
| 105710400100 | 710/400 | 4.175,58 |
| 105710450100 | 710/450 | 4.003,49 |
| 105710500100 | 710/500 | 3.006,81 |
| 105710560100 | 710/560 | 2.804,08 |
| 105710630100 | 710/630 | 2.632,85 |
| 105800063100 | 800/63 | 721,22 |
| 105800075100 | 800/75 | 727,67 |
| 105800090100 | 800/90 | 760,98 |
| 105800110100 | 800/110 | 763,27 |
| 105800125100 | 800/125 | 887,36 |
| 105800140100 | 800/140 | 907,63 |
| 105800160100 | 800/160 | 888,72 |
| 105800180100 | 800/180 | 1.029,04 |
| 105800200100 | 800/200 | 1.103,41 |
| 105800225100 | 800/225 | 1.127,01 |
| 105800250100 | 800/250 | 1.168,92 |
| 105800280100 | 800/280 | 1.247,11 |
| 105800315100 | 800/315 | 1.434,44 |
| 105800355100 | 800/355 | 5.462,18 |
| 105800400100 | 800/400 | 5.345,98 |
| 105800450100 | 800/450 | 5.173,89 |
| 105800500100 | 800/500 | 5.084,59 |
| 105800560100 | 800/560 | 3.823,04 |
| 105800630100 | 800/630 | 3.587,46 |
| 105800710100 | 800/710 | 3.414,13 |



SDR 11
REDUCCIÓN

| Ref. | Ø | €/Ud. |
|--------------|---------|----------|
| 110200160160 | 200/160 | 193,45 |
| 110225110160 | 225/110 | 264,28 |
| 110225160160 | 225/160 | 165,24 |
| 110225180160 | 225/180 | 173,74 |
| 110225200160 | 225/200 | 178,86 |
| 110250160160 | 250/160 | 199,46 |
| 110250180160 | 250/180 | 327,56 |
| 110280180160 | 280/180 | 319,07 |
| 110280200160 | 280/200 | 346,13 |
| 110280225160 | 280/225 | 217,81 |
| 110280250160 | 280/250 | 225,17 |
| 110315200160 | 315/200 | 332,06 |
| 110315225160 | 315/225 | 230,36 |
| 110315250160 | 315/250 | 237,73 |
| 110315280160 | 315/280 | 247,43 |
| 110355250160 | 355/250 | 649,79 |
| 110355280160 | 355/280 | 654,57 |
| 110355315160 | 355/315 | 510,28 |
| 110400280160 | 400/280 | 689,40 |
| 110400315160 | 400/315 | 534,51 |
| 110400355160 | 400/355 | 571,06 |
| 110450315160 | 450/315 | 581,00 |
| 110450355160 | 450/355 | 611,59 |
| 110450400160 | 450/400 | 638,43 |
| 110500355160 | 500/355 | 1.232,14 |
| 110500400160 | 500/400 | 1.459,74 |
| 110500450160 | 500/450 | 906,29 |
| 110560400160 | 560/400 | 1.331,91 |
| 110560450160 | 560/450 | 973,98 |
| 110560500160 | 560/500 | 1.331,57 |
| 110630450160 | 630/450 | 1.067,96 |
| 110630500160 | 630/500 | 1.104,51 |
| 110630560160 | 630/560 | 1.172,19 |

SDR 17
REDUCCIÓN

| Ref. | Ø | €/Ud. |
|--------------|----------|----------|
| 110225160100 | 225/160 | 142,65 |
| 110225180100 | 225/180 | 147,19 |
| 110225200100 | 225/200 | 150,69 |
| 110250160100 | 250/160 | 171,63 |
| 110250180100 | 250/180 | 282,74 |
| 110250225100 | 250/225 | 174,62 |
| 110280200100 | 280/200 | 295,37 |
| 110280225100 | 280/225 | 181,28 |
| 110280250100 | 280/250 | 186,22 |
| 110315160100 | 315/160 | 288,76 |
| 110315225100 | 315/225 | 189,85 |
| 110315250100 | 315/250 | 194,79 |
| 110315280100 | 315/280 | 201,45 |
| 110355250100 | 355/250 | 565,06 |
| 110355280100 | 355/280 | 573,22 |
| 110355315100 | 355/315 | 438,81 |
| 110400280100 | 400/280 | 583,22 |
| 110400315100 | 400/315 | 455,00 |
| 110400355100 | 400/355 | 592,18 |
| 110450315100 | 450/315 | 486,47 |
| 110450355100 | 450/355 | 512,11 |
| 110450400100 | 450/400 | 528,30 |
| 110500355100 | 500/355 | 1.062,35 |
| 110500400100 | 500/400 | 1.255,31 |
| 110500450100 | 500/450 | 757,25 |
| 110560250100 | 560/250 | 1.157,81 |
| 110560400100 | 560/400 | 1.454,63 |
| 110560450100 | 560/450 | 803,04 |
| 110560500100 | 560/500 | 828,06 |
| 110630450100 | 630/450 | 866,77 |
| 110630500100 | 630/500 | 891,79 |
| 110630560100 | 630/560 | 937,59 |
| 110710500100 | 710/500 | 2.004,61 |
| 110710560100 | 710/560 | 1.789,21 |
| 110710630100 | 710/630 | 1.630,48 |
| 110800560100 | 800/560 | 2.506,66 |
| 110800630100 | 800/630 | 2.289,47 |
| 110800710100 | 800/710 | 2.139,66 |
| 110900630100 | 900/630 | 3.456,89 |
| 110900710100 | 900/710 | 3.192,56 |
| 110900800100 | 900/800 | 2.571,11 |
| 110100710100 | 1000/710 | 5.301,86 |
| 110100800100 | 1000/800 | 4.127,70 |
| 110100900100 | 1000/900 | 5.024,41 |

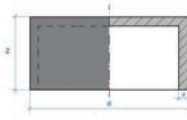

SDR 11
TAPÓN

| Ref. | Ø | €/Ud. |
|--------------|-----|--------|
| 138063000160 | 63 | 37,04 |
| 138075000160 | 75 | 42,95 |
| 138090000160 | 90 | 48,67 |
| 138110000160 | 110 | 60,44 |
| 138125000160 | 125 | 67,73 |
| 138140000160 | 140 | 75,51 |
| 138160000160 | 160 | 90,55 |
| 138180000160 | 180 | 106,86 |
| 138200000160 | 200 | 125,02 |
| 138225000160 | 225 | 145,40 |
| 138250000160 | 250 | 167,73 |
| 138280000160 | 280 | 197,40 |
| 138315000160 | 315 | 236,05 |
| 138355000160 | 355 | 315,37 |
| 138400000160 | 400 | 387,22 |
| 138450000160 | 450 | 496,36 |
| 138500000160 | 500 | 596,03 |
| 138560000160 | 560 | 760,01 |
| 138630000160 | 630 | 935,78 |

SDR 17
TAPÓN

| Ref. | Ø | €/Ud. |
|--------------|------|----------|
| 138063000100 | 63 | 32,64 |
| 138075000100 | 75 | 39,19 |
| 138090000100 | 90 | 43,83 |
| 138110000100 | 110 | 54,24 |
| 138125000100 | 125 | 60,08 |
| 138140000100 | 140 | 66,77 |
| 138160000100 | 160 | 79,81 |
| 138180000100 | 180 | 93,08 |
| 138200000100 | 200 | 108,88 |
| 138225000100 | 225 | 126,14 |
| 138250000100 | 250 | 144,96 |
| 138280000100 | 280 | 170,21 |
| 138315000100 | 315 | 203,06 |
| 138355000100 | 355 | 266,59 |
| 138400000100 | 400 | 326,67 |
| 138450000100 | 450 | 414,05 |
| 138500000100 | 500 | 496,94 |
| 138560000100 | 560 | 629,09 |
| 138630000100 | 630 | 774,60 |
| 138710000100 | 710 | 1.000,03 |
| 138800000100 | 800 | 1.255,00 |
| 138900000100 | 900 | 1.503,07 |
| 105180140100 | 1000 | 155,21 |



Pasamuros y juntas

INFRAESTRUCTURA





PASAMUROS DE PE

Con extremo liso & brida según EN1092 PN10

| Ref. | DN | Ø | L | €/Ud |
|-----------|------|------|-----|-----------|
| 750310106 | 25 | 32 | 250 | 192,16 |
| 750410106 | 32 | 40 | 250 | 222,22 |
| 750510106 | 40 | 50 | 250 | 235,32 |
| 750610106 | 50 | 63 | 250 | 251,09 |
| 750710106 | 65 | 75 | 250 | 281,42 |
| 750910106 | 80 | 90 | 250 | 347,88 |
| 751110106 | 100 | 110 | 250 | 367,09 |
| 751210106 | 100 | 125 | 250 | 377,40 |
| 751310106 | 125 | 125 | 250 | 391,28 |
| 751410106 | 125 | 140 | 250 | 429,47 |
| 751610106 | 150 | 160 | 250 | 494,51 |
| 751810106 | 150 | 180 | 250 | 538,57 |
| 752010106 | 200 | 200 | 250 | 584,15 |
| 752210106 | 200 | 225 | 250 | 630,93 |
| 752510106 | 250 | 250 | 250 | 767,50 |
| 752810106 | 250 | 280 | 250 | 837,07 |
| 753110106 | 300 | 315 | 250 | 878,41 |
| 753410106 | 300 | 355 | 250 | 1.044,01 |
| 753510106 | 350 | 355 | 250 | 1.130,79 |
| 753910106 | 350 | 400 | 250 | 1.372,60 |
| 754010106 | 400 | 400 | 250 | 1.369,66 |
| 754410106 | 400 | 450 | 250 | 1.618,86 |
| 754510106 | 500 | 450 | 250 | 1.643,16 |
| 755010106 | 500 | 500 | 250 | 2.091,26 |
| 755410106 | 500 | 560 | 250 | 2.263,84 |
| 755610106 | 600 | 560 | 300 | 2.050,93 |
| 756310106 | 600 | 630 | 300 | 3.075,81 |
| 757110106 | 700 | 710 | 350 | CONSULTAR |
| 758010106 | 800 | 800 | 350 | CONSULTAR |
| 759010106 | 900 | 900 | 400 | CONSULTAR |
| 759110106 | 1000 | 1000 | 400 | CONSULTAR |

Junta central en EPDM, anclajes en acero cincado.

Extremo liso SDR 17 según 12201.

Para paredes con espesor = L.

Consultar alternativa en PN16.

Consultar longitudes extra.



PASAMUROS DE PE

Embridado según EN1092 PN10

| Ref. | DN | Ø | L | €/Ud |
|-----------|------|------|-----|-----------|
| 750320106 | 25 | 32 | 250 | 262,73 |
| 750420106 | 32 | 40 | 250 | 354,67 |
| 750520106 | 40 | 50 | 250 | 511,92 |
| 750620106 | 50 | 63 | 250 | 412,92 |
| 750720106 | 65 | 75 | 250 | 482,28 |
| 750920106 | 80 | 90 | 250 | 548,30 |
| 751120106 | 100 | 110 | 250 | 604,21 |
| 751220106 | 100 | 125 | 250 | 621,02 |
| 751320106 | 125 | 125 | 250 | 635,94 |
| 751420106 | 125 | 140 | 250 | 705,84 |
| 751620106 | 150 | 160 | 250 | 825,17 |
| 751820106 | 150 | 180 | 250 | 871,95 |
| 752020106 | 200 | 200 | 250 | 947,28 |
| 752220106 | 200 | 225 | 250 | 1.018,94 |
| 752520106 | 250 | 250 | 250 | 1.274,01 |
| 752820106 | 250 | 280 | 250 | 1.357,33 |
| 753120106 | 300 | 315 | 250 | 1.461,79 |
| 753420106 | 300 | 355 | 250 | 1.706,48 |
| 753520106 | 350 | 355 | 250 | 1.833,16 |
| 753920106 | 350 | 400 | 250 | 2.253,67 |
| 754020106 | 400 | 400 | 250 | 2.320,35 |
| 754420106 | 400 | 450 | 250 | 2.564,98 |
| 754520106 | 500 | 450 | 250 | 3.190,34 |
| 755020106 | 500 | 500 | 250 | 3.470,97 |
| 755420106 | 500 | 560 | 250 | 3.853,30 |
| 755620106 | 600 | 560 | 300 | 3.615,83 |
| 756320106 | 600 | 630 | 300 | 5.112,74 |
| 757120106 | 700 | 710 | 350 | CONSULTAR |
| 758020106 | 800 | 800 | 350 | CONSULTAR |
| 759020106 | 900 | 900 | 400 | CONSULTAR |
| 759120106 | 1000 | 1000 | 400 | CONSULTAR |

Junta central en EPDM, anclajes en acero cincado

Extremo liso SDR 17 según 12201

Para paredes con espesor = L.

Consultar alternativa en PN16.

Otras configuraciones: pasamuros en ángulo disponibles
 previa consulta.



JUNTAS YUNTALEX

| Ref. | Ø Tubo | DN Brida | Uds./caja | €/Ud |
|--------------|--------|----------|-----------|-------|
| 315020045535 | 20 | 15 | 50 | 1,78 |
| 315025055535 | 25 | 20 | 50 | 1,80 |
| 315030065535 | 32 | 25 | 50 | 1,90 |
| 315045085535 | 50 | 40 | 50 | 1,98 |
| 315055100535 | 63 | 50 | 50 | 2,12 |
| 315070120535 | 75 | 65 | 50 | 2,24 |
| 315085135535 | 90 | 80 | 50 | 2,58 |
| 315105155535 | 110 | 100 | 50 | 2,60 |
| 315135185535 | 125 | 125 | 50 | 2,87 |
| 315160210535 | 160 | 150 | 50 | 3,52 |
| 315210265535 | 200 | 200 | 50 | 4,72 |
| 315260320535 | 250 | 250 | 25 | 4,96 |
| 315310375535 | 315 | 300 | 15 | 7,80 |
| 315360435535 | 355 | 350 | 15 | 12,00 |
| 315410485535 | 400 | 400 | 15 | 12,47 |
| 315510610535 | 500 | 500 | 15 | 22,34 |
| 315610725535 | 630 | 600 | 15 | 29,77 |

Junta de plástico flexible, totalmente terminada que no requiere otra manipulación que la de su inmediata colocación entre bridas de unión de dos tubos durante su atornillado. Anticorrosivas, impermeables, imputrescibles e inalterables a la acción de la mayoría de los ácidos, aceites e hidrocarburos. Resistencia a la temperatura de hasta 60°C y presiones hasta 30 atmósferas. Sin desperdicios por recortes ni costes de mano de obra por manipulación. Se mantienen fijas con tan solo dos dedos durante el atornillado de las bridas entre sí. Duración ilimitada.



QPV-J

| Ref. | Ø | €/FKM |
|-----------|-----|-------|
| QH VX020F | 20 | 5,94 |
| QH VX025F | 25 | 5,94 |
| QH VX032F | 32 | 6,33 |
| QH VX040F | 40 | 8,84 |
| QH VX050F | 50 | 8,77 |
| QH VX063F | 63 | 14,77 |
| QH VX075F | 75 | 19,70 |
| QH VX090F | 90 | 21,85 |
| QH VX110F | 110 | 39,24 |
| QH VX125F | 125 | 54,14 |
| QH VX140F | 140 | 62,56 |
| QH VX160F | 160 | 91,68 |

Junta plana para portabridas.
Junta en FKM (vitón).

Ver descuentos aplicables según "Familia PVC".



QPV-J

| Ref. | Ø | €/EPDM |
|-----------|-----|--------|
| QH VX020E | 20 | 0,70 |
| QH VX025E | 25 | 0,77 |
| QH VX032E | 32 | 1,17 |
| QH VX040E | 40 | 1,34 |
| QH VX050E | 50 | 1,61 |
| QH VX063E | 63 | 2,12 |
| QH VX075E | 75 | 3,27 |
| QH VX090E | 90 | 4,72 |
| QH VX110E | 110 | 5,99 |
| QH VX125E | 125 | 6,71 |
| QH VX140E | 140 | 2,99 |
| QH VX160E | 160 | 8,38 |
| QH VX200E | 200 | 9,82 |
| QH VX225E | 225 | 12,20 |
| QH VX250E | 250 | 34,24 |

Junta plana para portabridas.
Junta en EPDM.

Ver descuentos aplicables según "Familia PVC".

Accesorios electrosoldables PE

Tomas simples

Tomas en carga

Válvulas PE para agua y gas



Accesorios electrosoldables

Frialen

INFRAESTRUCTURA





Más información



Aplicación



Aplicación

**MB - MANGUITOS CON TOPE, SDR 11**

Máxima presión de trabajo permitida 16 bar (agua) / 10 bar (gas)

| Ref. | Ø | Ud./Caja | €/Ud. |
|--------|----|----------|-------|
| 612680 | 20 | 110 | 2,75 |
| 612681 | 25 | 90 | 2,82 |
| 616517 | 32 | 60 | 2,87 |
| 612683 | 40 | 40 | 3,22 |
| 612684 | 50 | 25 | 5,01 |
| 612685 | 63 | 15 | 5,11 |
| 612686 | 75 | 50 | 9,54 |
| 612687 | 90 | 30 | 8,84 |

Los manguitos MB SDR11 pueden ser soldados en tuberías SDR11 a SDR17,6

Espesor mínimo de tubo a soldar: 3.0 mm



Aplicación

**UB SDR9 - MANGUITOS SIN TOPE, SDR 9**

Máxima presión de trabajo permitida 20 bar (agua)

| Ref. | Ø | Ud./Caja | €/Ud. |
|--------|-----|----------|----------|
| 616441 | 400 | 1 | 726,76 |
| 616447 | 450 | 1 | 890,87 |
| 616445 | 500 | 1 | 1.257,26 |
| 616446 | 560 | 1 | 2.981,96 |
| 616439 | 630 | 1 | 4.133,66 |

Los manguitos UB SDR9 pueden ser soldados en tuberías SDR9 y SDR11

UB - MANGUITOS SIN TOPE, SDR 11

Máxima presión de trabajo permitida 16 bar (agua) / 10 bar (gas)

| Ref. | Ø | Ud./Caja | €/Ud. |
|--------|------|----------|----------|
| 612668 | 110 | 24 | 10,32 |
| 612669 | 125 | 16 | 14,18 |
| 615001 | 140 | 12 | 19,03 |
| 612671 | 160 | 8 | 19,18 |
| 612672 | 180 | 6 | 33,11 |
| 612673 | 200 | 1 | 37,00 |
| 612674 | 225 | 1 | 46,89 |
| 617278 | 250 | 1 | 90,73 |
| 615073 | 280 | 1 | 122,25 |
| 612670 | 315 | 1 | 147,91 |
| 615074 | 355 | 1 | 200,20 |
| 615075 | 400* | 1 | 293,61 |
| 615076 | 450* | 1 | 523,32 |
| 615124 | 500* | 1 | 605,83 |
| 616312 | 560* | 1 | 2.270,69 |
| 616269 | 630* | 1 | 2.571,73 |
| 616313 | 710* | 1 | 2.898,95 |
| 616314 | 800* | 1 | 7.382,31 |

* zonas de soldadura separada

Los manguitos UB SDR11 pueden ser soldados en tuberías SDR11 a SDR17,6

Espesor mínimo de tubo a soldar: 3.0 mm



Aplicación



UB - MANGUITOS SIN TOPE, SDR 17

Máxima presión de trabajo permitida 10 bar (agua) / 5 bar (gas)

| Ref. | Ø | Ud./Caja | €/Ud. |
|--------|--------|----------|-----------|
| 616529 | 315 | 1 | 119,78 |
| 616530 | 355 | 1 | 199,76 |
| 616531 | 400* | 1 | 220,56 |
| 616532 | 450* | 1 | 312,70 |
| 616533 | 500* | 1 | 424,55 |
| 615706 | 560* | 1 | 643,11 |
| 615726 | 630* | 1 | 830,64 |
| 615994 | 710* | 1 | 1.142,99 |
| 616290 | 800* | 1 | 1.500,45 |
| 616345 | 900* | 1 | 2.020,54 |
| 616403 | 1000** | 1 | 9.307,51 |
| 616416 | 1200** | 1 | 16.565,08 |

* zonas de soldadura separada

** Para soldar se necesita una FRIAMAT XL

Los manguitos UB SDR17 pueden ser soldados en tuberías SDR17 y SDR26



Aplicación



UB PN25 - MANGUITOS SIN TOPE, SDR 7,4

Máxima presión de trabajo permitida 25 bar (agua)

| Ref. | Ø | Ud./Caja | €/Ud. |
|--------|------|----------|--------|
| 616270 | 90 | 30 | 10,99 |
| 616271 | 110 | 24 | 21,38 |
| 616272 | 125 | 16 | 24,25 |
| 616273 | 140 | 12 | 105,01 |
| 616274 | 160 | 8 | 129,74 |
| 616282 | 180 | 6 | 130,27 |
| 616283 | 200 | 2 | 140,39 |
| 616284 | 225 | 1 | 156,18 |
| 616285 | 250 | 1 | 210,32 |
| 616287 | 315* | 1 | 460,11 |
| 616288 | 355* | 1 | 501,20 |

* zonas de soldadura separada

Los manguitos UB SDR7,4 pueden ser soldados en tuberías SDR7,4 a SDR11



Aplicación



Para aguas residuales

AM - MANGUITOS SIN TOPE, SDR 17

Máxima presión de trabajo permitida 10 bar (agua)

| Ref. | Ø | Ud./Caja | €/Ud. |
|--------|-----|----------|--------|
| 680001 | 110 | 24 | 11,66 |
| 680013 | 125 | 22 | 16,58 |
| 680002 | 160 | 12 | 15,35 |
| 680003 | 180 | 8 | 26,83 |
| 680004 | 200 | 1 | 26,93 |
| 680005 | 225 | 4 | 45,77 |
| 680006 | 250 | 1 | 108,70 |
| 680007 | 280 | 1 | 117,17 |

* zonas de soldadura separada

Los manguitos AM SDR17 pueden ser soldados en tuberías SDR17 a SDR33



Aplicación



REM - MANGUITOS DE TRANSICIÓN RELINING

PE 100 SDR17 Presión de servicio máxima admisible 10 bar (agua)/5 bar (gas)

| Ref. | Ø | Ud./Caja | €/Ud. |
|--------|---------|----------|--------|
| 615569 | 110/100 | 24 | 138,27 |
| 615571 | 160/150 | 12 | 250,50 |
| 615576 | 315/300 | 1 | 989,51 |

Con código de barras de precalentamiento

Los manguitos REM pueden ser soldados en tuberías SDR17 a SDR17,6



Aplicación



MV - MANGUITOS DE CIERRE - TAPONES

PE 100 SDR11 - Máxima presión de trabajo permitida 16 bar (agua) / 10 bar (gas)

| Ref. | Ø | Ud./Caja | €/Ud. |
|--------|-----|----------|--------|
| 612025 | 20 | 40 | 5,51 |
| 612026 | 25 | 40 | 5,60 |
| 612027 | 32* | 40 | 5,90 |
| 612028 | 40* | 25 | 7,23 |
| 612029 | 50 | 20 | 10,24 |
| 612030 | 63 | 15 | 10,50 |
| 612031 | 75 | 20 | 20,69 |
| 612032 | 90 | 16 | 23,74 |
| 612033 | 110 | 12 | 29,09 |
| 612034 | 125 | 16 | 42,94 |
| 612035 | 160 | 10 | 56,73 |
| 616183 | 180 | 6 | 135,30 |
| 616184 | 200 | 4 | 174,08 |
| 616185 | 225 | 4 | 251,88 |

* También recomendado para sellar los extremos de accionamiento de las cuchillas de corte de las tomas en carga FRIALEN DAA/DAP ≤ d63.

Los tapones MV pueden ser soldados en tuberías SDR11 a SDR17,6

Espesor mínimo de tubo a soldar: 3.0 mm



Aplicación



MR - MANGUITOS DE REDUCCIÓN

Máxima presión de trabajo permitida 16 bar (agua) / 10 bar (gas)

| Ref. | Ø | Ud./Caja | €/Ud. |
|--------|---------|----------|--------|
| 616824 | 20-16 | 70 | 5,83 |
| 616452 | 32-16 | 70 | 6,78 |
| 615386 | 32-20 | 80 | 7,42 |
| 615502 | 32-25 | 70 | 6,95 |
| 615387 | 40-20 | 60 | 8,91 |
| 616751 | 40-25 | 120 | 7,07 |
| 615388 | 40-32 | 50 | 13,06 |
| 616752 | 50-25 | 130 | 8,76 |
| 612070 | 50-32 | 32 | 9,32 |
| 612071 | 50-40 | 25 | 7,86 |
| 615389 | 63-32 | 18 | 9,58 |
| 615390 | 63-40 | 16 | 9,58 |
| 612072 | 63-50 | 16 | 9,58 |
| 616583 | 75-63 | 15 | 19,02 |
| 615391 | 90-50 | 15 | 21,78 |
| 615392 | 90-63 | 15 | 19,80 |
| 616582 | 90-75 | 15 | 22,93 |
| 615393 | 110-63 | 10 | 23,00 |
| 615693 | 110-90 | 8 | 23,28 |
| 615694 | 125-90 | 8 | 28,70 |
| 616510 | 125-110 | 16 | 53,33 |
| 615695 | 160-110 | 8 | 45,19 |
| 616511 | 180-125 | 1 | 80,21 |
| 616356 | 225-160 | 1 | 133,80 |

Las reducciones MR pueden ser soldadas en tuberías SDR11 a SDR17,6

Espesor mínimo de tubo a soldar: 3.0 mm



Aplicación



WS11° - CODOS 11° M/H

PE 100 SDR11 Presión de servicio máxima admisible 16 bar (agua)/10 bar (gas)

| Ref. | Ø | Ud./Caja | €/Ud. |
|--------|-----|----------|--------|
| 616139 | 110 | 8 | 34,16 |
| 616140 | 125 | 5 | 46,60 |
| 616141 | 160 | 8 | 89,32 |
| 616142 | 180 | 4 | 115,70 |
| 616143 | 225 | 1 | 199,57 |

Los codos WS 11 ° pueden ser soldados en tuberías SDR11 a SDR17,6

Espesor mínimo de tubo a soldar: 3.0 mm



Aplicación



W30° - CODOS 30°

PE 100 SDR11 Presión de servicio máxima admisible 16 bar (agua)/10 bar (gas)

| Ref. | Ø | Ud./Caja | €/Ud. |
|--------|-----|----------|--------|
| 615272 | 90 | 8 | 28,24 |
| 615273 | 110 | 6 | 40,36 |
| 615274 | 125 | 4 | 54,69 |
| 615340 | 160 | 5 | 105,65 |
| 616261 | 180 | 3 | 133,93 |
| 616262 | 200 | 1 | 184,22 |
| 616263 | 225 | 1 | 226,04 |

Los codos W 30 ° pueden ser soldados en tuberías SDR11 a SDR17,6



Aplicación



W45° - CODOS 45°

PE 100 SDR11 Presión de servicio máxima admisible 16 bar (agua)/10 bar (gas)

| Ref. | Ø | Ud./Caja | €/Ud. |
|--------|-----|----------|--------|
| 616687 | 25 | 150 | 7,83 |
| 612092 | 32 | 45 | 7,70 |
| 612094 | 40 | 25 | 9,62 |
| 612096 | 50 | 20 | 10,92 |
| 612098 | 63 | 10 | 11,08 |
| 612100 | 75 | 14 | 20,36 |
| 612102 | 90 | 8 | 23,68 |
| 612104 | 110 | 10 | 33,70 |
| 612106 | 125 | 10 | 54,08 |
| 615275 | 160 | 4 | 83,77 |
| 615687 | 180 | 3 | 89,71 |
| 616264 | 200 | 1 | 207,35 |
| 615688 | 225 | 1 | 161,66 |

Los codos W 45 ° pueden ser soldados en tuberías SDR11 a SDR17,6



Aplicación



W45° XL - CODOS 45° XL

PE 100 SDR11 Presión de servicio máxima admisible 16 bar (agua)/10 bar (gas)

| Ref. | Ø | Ud./Caja | €/Ud. |
|--------|-----|----------|----------|
| 616404 | 250 | 1 | 813,99 |
| 616405 | 280 | 1 | 985,90 |
| 616406 | 315 | 1 | 1.303,19 |

Los codos W 45 ° XL pueden ser soldados en tuberías SDR11 a SDR17,6



Aplicación



W90° XL - CODO 90° XL

PE 100 SDR11 Presión de servicio máxima admisible 16 bar (agua)/10 bar (gas)

| Ref. | Ø | Ud./Caja | €/Ud. |
|--------|-----|----------|----------|
| 616408 | 250 | 1 | 818,84 |
| 616409 | 280 | 1 | 985,90 |
| 616410 | 315 | 1 | 1.303,19 |

Los codos W 90 ° XL pueden ser soldados en tuberías SDR11 a SDR17,6



Aplicación



W90° - CODOS 90°

PE 100 SDR11 Presión de servicio máxima admisible 16 bar (agua)/10 bar (gas)

| Ref. | Ø | Ud./Caja | €/Ud. |
|--------|-----|----------|--------|
| 616686 | 20 | 200 | 7,35 |
| 612091 | 25 | 60 | 7,39 |
| 612093 | 32 | 45 | 7,41 |
| 612095 | 40 | 25 | 7,85 |
| 612097 | 50 | 20 | 11,79 |
| 612099 | 63 | 8 | 11,06 |
| 612101 | 75 | 12 | 19,37 |
| 612103 | 90 | 6 | 21,56 |
| 612105 | 110 | 10 | 31,19 |
| 612107 | 125 | 8 | 50,27 |
| 615276 | 160 | 3 | 83,67 |
| 615689 | 180 | 3 | 95,79 |
| 616265 | 200 | 2 | 195,67 |
| 615690 | 225 | 1 | 234,82 |

Los codos W 90 ° pueden ser soldados en tuberías SDR11 a SDR17,6



Aplicación



TA RED - TÉS REDUCIDAS

PE 100 SDR11 Presión de servicio máxima admisible 16 bar (agua)/10 bar (gas)

| Ref. | Ø | Ud./Caja | €/Ud. |
|--------|--------|----------|-------|
| 616417 | 32- 20 | 30 | 9,23 |
| 616418 | 40- 32 | 20 | 12,78 |
| 616419 | 50- 32 | 10 | 16,30 |
| 616420 | 50- 40 | 10 | 15,73 |
| 616421 | 63- 32 | 10 | 17,64 |
| 616422 | 63- 40 | 10 | 18,52 |
| 616423 | 63- 50 | 10 | 18,69 |

Las tés TA red pueden ser soldadas en tuberías SDR11 a SDR17,6



Aplicación



TA - TÉS CON DERIVACIÓN EXTRA LARGA

PE 100 SDR11 Presión de servicio máxima admisible 16 bar (agua)/10 bar (gas)

| Ref. | Ø | Ud./Caja | €/Ud. |
|--------|----|----------|-------|
| 616685 | 20 | 200 | 8,39 |
| 616338 | 25 | 40 | 8,49 |
| 615719 | 32 | 30 | 8,59 |
| 615720 | 40 | 20 | 12,08 |
| 615721 | 50 | 10 | 13,61 |
| 615722 | 63 | 10 | 14,27 |

Las tés TA red pueden ser soldadas en tuberías SDR11 a SDR17,6
Espesor mínimo de tubo a soldar: 3.0 mm



Aplicación



T - TÉS DE TRES BOCAS Y DOS SOLDADURAS

PE 100 SDR11 Presión de servicio máxima admisible 16 bar (agua)/10 bar (gas)

| Ref. | Ø | Ud./Caja | €/Ud. |
|--------|-----|----------|--------|
| 612165 | 75 | 8 | 27,84 |
| 612166 | 90 | 10 | 46,91 |
| 612167 | 110 | 6 | 46,55 |
| 612168 | 125 | 5 | 65,82 |
| 615277 | 160 | 3 | 110,34 |
| 615691 | 180 | 2 | 165,71 |
| 616266 | 200 | 1 | 215,81 |
| 615692 | 225 | 1 | 235,45 |

Las tés T pueden ser soldadas en tuberías SDR11 a SDR17,6



Aplicación



T XL - TÉS XL

PE 100 SDR11 Presión de servicio máxima admisible 16 bar (agua)/10 bar (gas)

| Ref. | Ø | Ud./Caja | €/Ud. |
|--------|------|----------|----------|
| 616412 | 250* | 1 | 1.157,78 |
| 616413 | 280* | 1 | 1.443,36 |
| 616414 | 315* | 1 | 1.920,63 |

*Pieza conformada por cuerpo inyectado y dos manguitos bifilares soldados en uno de sus extremos. Para alternativa de inyectado + 3 manguitos utilizar precios de Ref.s TEPE11000250, TEPE11000280 Y TEPE11000315 dela familia de Inyectados y las 617278,615073 y 612670 de Electrosoldables.

Las tés T XL pueden ser soldadas en tuberías SDR11 a SDR17,6



Aplicación



Y - PIEZAS EN Y DE PE 100 SDR11

PE 100 SDR11 Presión de servicio máxima admisible 16 bar (agua)/10 bar (gas)

| Ref. | Ø | Ud./Caja | €/Ud. |
|--------|----------|----------|-------|
| 640034 | 32-32-40 | 28 | 37,95 |
| 640036 | 40-40-50 | 18 | 41,23 |



Aplicación



TE RED - XL - TÉS REDUCIDA XL

PE 100 SDR11 Presión de servicio máxima admisible 16 bar (agua)/10 bar (gas)

| Ref. | Ø | Ud./Caja | €/Ud. |
|--------|---------|----------|----------|
| 616426 | 250/110 | 1 | 1.120,84 |
| 616427 | 250/225 | 1 | 1.224,17 |
| 616428 | 280/110 | 1 | 1.375,25 |
| 616429 | 280/225 | 1 | 1.482,28 |
| 616430 | 315/110 | 1 | 1.720,85 |
| 616431 | 315/225 | 1 | 1.768,53 |

*Pieza conformada por cuerpo inyectado y dos manguitos bifilares soldados en uno de sus extremos.

Para alternativa de manipulados + 2 manguitos utilizar precios de Ref.s de tés reducidas en capítulo Manipulados y para los manguitos las Ref.s en capítulo Electrosoldables.

Las tés T red XL pueden ser soldadas en tuberías SDR11 a SDR17,6



Aplicación



YS - PIEZAS EN YS CON ESPIRALES CALEFACTORAS Y EXTREMO PE 100 SDR11

PE 100 SDR11 Presión de servicio máxima admisible 16 bar (agua)/10 bar (gas)

| Ref. | Ø | Ud./Caja | €/Ud. |
|--------|----------|----------|-------|
| 640035 | 32-32-40 | 28 | 31,77 |
| 640037 | 40-40-50 | 18 | 36,00 |

Las Y y las YS pueden ser soldadas en tuberías SDR11 a SDR17,6



USTR - TRANSICIONES PE-AD/ACERO

PE 100 SDR11 Presión de servicio máxima admisible 10 bar (gas)

| Ref. | Ø | Ud./Caja | €/Ud. |
|--------|---------|----------|--------|
| 612780 | 32/25 | 15 | 44,08 |
| 612781 | 40/32 | 10 | 49,38 |
| 612782 | 50/40 | 8 | 61,17 |
| 612783 | 63/50 | 6 | 75,56 |
| 612789 | 75/65 | 4 | 172,39 |
| 612784 | 90/80 | 1 | 244,37 |
| 612785 | 110/100 | 1 | 249,42 |
| 612786 | 125/100 | 1 | 298,10 |
| 612787 | 160/150 | 1 | 443,97 |
| 615030 | 180/150 | 1 | 598,92 |
| 612795 | 200/200 | 1 | 677,95 |
| 612370 | 225/200 | 1 | 787,63 |

Otras dimensiones de rosca, o modelos, bajo consulta.
Las USTR pueden ser soldadas en tuberías SDR11 a SDR17,6



USTRS - TRANSICIONES PE-AD/ACERO (PARA SOLDAR CON MANGUITOS)

PE 100 SDR11 Presión de servicio máxima admisible 10 bar (gas)

| Ref. | Ø | Ud./Caja | €/Ud. |
|--------|---------|----------|-----------|
| 616632 | 20/15 | 21 | 27,80 |
| 616633 | 25/20 | 21 | 30,89 |
| 616634 | 32/25 | 18 | 34,13 |
| 616635 | 40/32 | 12 | 39,02 |
| 616636 | 50/40 | 8 | 44,35 |
| 616637 | 63/50 | 6 | 58,56 |
| 616638 | 75/65 | 2 | 106,22 |
| 616639 | 90/80 | 2 | 108,31 |
| 616640 | 110/100 | 2 | 159,63 |
| 616641 | 125/100 | 2 | 166,93 |
| 616642 | 140/125 | 1 | 232,94 |
| 616643 | 160/150 | 1 | 383,62 |
| 616644 | 180/150 | 1 | 387,25 |
| 616645 | 200/200 | 1 | 564,16 |
| 616646 | 225/200 | 1 | 572,45 |
| 616647 | 250/250 | 1 | 1.117,37 |
| 616648 | 280/250 | 1 | 1.187,95 |
| 616649 | 315/300 | 1 | 1.748,74 |
| 616650 | 355/300 | 1 | 1.905,27 |
| 616651 | 400/400 | 1 | 3.934,36 |
| 616652 | 500/500 | 1 | 8.072,25 |
| 616653 | 630/600 | 1 | 13.639,31 |

Otras dimensiones de rosca, o modelos, bajo consulta.
Las USTRS pueden ser soldadas en tuberías SDR11 a SDR17,6



UFLG - TRANSICIONES PARA GAS LICUADO EN PE-AD/COBRE

PE 100 SDR11 Presión de servicio máxima admisible 5 bar (gas)

| Ref. | Ø | Ud./Caja | €/Ud. |
|--------|-------|----------|-------|
| 615733 | 32-20 | 25 | 84,25 |

Las UFLG pueden ser soldadas en tuberías SDR11 a SDR17,6



USTN - MANGUITOS DE TRANSICIÓN PE-AD/ACERO (ROSCA MACHO)

PE 100 SDR11 Presión de servicio máxima admisible 5 bar (gas)

| Ref. | Ø | Ud./Caja | €/Ud. |
|--------|---------|----------|-------|
| 612580 | 32-1" | 20 | 30,51 |
| 612582 | 40-1 ¼" | 20 | 39,87 |
| 612584 | 50-1 ½" | 15 | 50,28 |
| 612586 | 63-2" | 10 | 65,64 |

Otras dimensiones de rosca,, bajo consulta.
Las transiciones USTN pueden ser soldadas en tuberías SDR11 a SDR17,6
Espesor mínimo de tubo a soldar: 3.0 mm



USTM - MANGUITOS DE TRANSICIÓN PE-AD/ACERO (ROSCA HEMBRA)

PE 100 SDR11 Presión de servicio máxima admisible 5 bar (gas)

| Ref. | Ø | Ud./Caja | €/Ud. |
|--------|---------|----------|-------|
| 612570 | 32-1" | 20 | 32,23 |
| 612572 | 40-1 ¼" | 20 | 43,18 |
| 612574 | 50-1 ½" | 15 | 52,74 |
| 612576 | 63-2" | 10 | 71,22 |

Otras dimensiones de rosca,, bajo consulta.
Las transiciones USTM pueden ser soldadas en tuberías SDR11 a SDR17,6
Espesor mínimo de tubo a soldar: 3.0 mm



Aplicación



WUSTN 90° - CODOS DE TRANSICIÓN 90° UNIÓN PE-AD/ACERO (ROSCA MACHO)

PE 100 SDR11 Presión de servicio máxima admisible 5 bar (gas)

| Ref. | Ø | Ud./Caja | €/Ud. |
|--------|---------|----------|-------|
| 612602 | 40-1 ¼" | 15 | 77,29 |
| 612604 | 50-1 ½" | 10 | 61,54 |
| 612606 | 63-2" | 10 | 80,40 |

Otras dimensiones de rosca, bajo consulta.

Las transiciones WUSTN pueden ser soldadas en tuberías SDR11 a SDR17,6

Espesor mínimo de tubo a soldar: 3.0 mm



Aplicación



WUSTM 90° - CODOS DE TRANSICIÓN 90° UNIÓN PE-AD/ACERO (ROSCA HEMBRA)

PE 100 SDR11 Presión de servicio máxima admisible 5 bar (gas)

| Ref. | Ø | Ud./Caja | €/Ud. |
|--------|---------|----------|-------|
| 612610 | 32-1" | 20 | 33,49 |
| 612611 | 40-1" | 15 | 62,67 |
| 612612 | 40-1 ¼" | 15 | 75,40 |
| 612614 | 50-1 ½" | 10 | 56,36 |
| 612616 | 63-2" | 10 | 78,20 |

Otras dimensiones de rosca, o modelos, bajo consulta.

Las transiciones WUSTM pueden ser soldadas en tuberías SDR11 a SDR17,6

Espesor mínimo de tubo a soldar: 3.0 mm



Aplicación



MUN - MANGUITOS DE TRANSICIÓN UNIÓN PE-AD/LATÓN (ROSCA MACHO HEXAGONAL)

PE 100 SDR11 Presión de servicio máxima admisible 16 bar (agua)

| Ref. | Ø | Ud./Caja | €/Ud. |
|--------|---------|----------|--------|
| 612712 | 32-1" | 20 | 25,39 |
| 612709 | 32-1 ¼" | 20 | 37,61 |
| 612698 | 32-1 ½" | 15 | 39,67 |
| 612721 | 40-1" | 20 | 37,59 |
| 612713 | 40-1 ¼" | 20 | 32,11 |
| 612718 | 40-1 ½" | 20 | 43,22 |
| 612725 | 40-2" | 20 | 74,45 |
| 612719 | 50-1" | 15 | 50,43 |
| 612716 | 50-1 ¼" | 15 | 49,06 |
| 612714 | 50-1 ½" | 15 | 40,59 |
| 612706 | 50-2" | 15 | 56,40 |
| 612722 | 63-1 ¼" | 10 | 81,58 |
| 612717 | 63-1 ½" | 10 | 71,97 |
| 612715 | 63-2" | 10 | 60,21 |
| 612694 | 75-2" | 10 | 140,96 |
| 612695 | 75-2 ½" | 10 | 140,59 |

Estándar: latón. Otros materiales bajo consulta.

Otras dimensiones de rosca, bajo consulta.

Las transiciones MUN pueden ser soldadas en tuberías SDR11 a SDR17,6

Espesor mínimo de tubo a soldar: 3.0 mm



Aplicación



MUM - MANGUITOS DE TRANSICIÓN UNIÓN PE-AD/FUNDICIÓN (ROSCA HEMBRA HEXAGONAL)

PE 100 SDR11 Presión de servicio máxima admisible 16 bar (agua)

| Ref. | Ø | Ud./Caja | €/Ud. |
|--------|---------|----------|--------|
| 612595 | 32-1" | 20 | 37,61 |
| 612596 | 40-1 ¼" | 20 | 52,43 |
| 612692 | 50-1 ½" | 15 | 63,45 |
| 612708 | 63-1 ½" | 10 | 149,50 |
| 612693 | 63-2" | 10 | 96,88 |

Estándar: latón. Otros materiales bajo consulta.

Otras dimensiones de rosca, bajo consulta.

Las transiciones MUM pueden ser soldadas en tuberías SDR11 a SDR17,6

Espesor mínimo de tubo a soldar: 3.0 mm



Aplicación



UAM ET - MANGUITOS DE TRANSICIÓN PE-AD / LATÓN CON TUERCA MÓVIL Y ROSCA HEMBRA

PE 100 SDR11 Presión de servicio máxima admisible 16 bar (agua)

| Ref. | Ø | Ud./Caja | €/Ud. |
|--------|-----------|----------|--------|
| 616654 | 25-3/4" | 100 | 46,00 |
| 616655 | 32-1" | 60 | 54,13 |
| 616626 | 40-1 1/4" | 35 | 68,67 |
| 616627 | 50-1 1/2" | 30 | 77,90 |
| 616628 | 63-2" | 20 | 107,63 |
| 616629 | 63-1 1/2" | 20 | 96,98 |

Otras dimensiones de rosca, bajo solicitud.

Estándar: latón, acero bajo consulta

La junta de sellado no está incluida



Aplicación



WUN 90° - CODOS DE TRANSICIÓN PE-AD/ LATÓN (ROSCA MACHO HEXAGONAL)

PE 100 SDR11 Presión de servicio máxima admisible 16 bar (agua)

| Ref. | Ø | Ud./Caja | €/Ud. |
|--------|-----------|----------|-------|
| 612120 | 32-1" | 20 | 28,91 |
| 612140 | 32-1 1/2" | 20 | 41,80 |
| 612127 | 40-1" | 15 | 39,16 |
| 612122 | 40-1 1/4" | 15 | 43,78 |
| 612121 | 40-1 1/2" | 15 | 44,88 |
| 612119 | 50-1" | 10 | 51,40 |
| 612123 | 50-1 1/4" | 10 | 50,60 |
| 612124 | 50-1 1/2" | 10 | 42,02 |
| 612125 | 63-1 1/2" | 10 | 75,40 |
| 612126 | 63-2" | 10 | 71,23 |

Estándar: latón. Otros materiales bajo consulta.

Otras dimensiones de rosca, bajo consulta.



Aplicación



UAN - TRANSICIONES ADAPTADOR MACHO PE-AD/LATÓN

PE 100 SDR11 Presión de servicio máxima admisible 16 bar (agua)/5 bar (gas)

| Ref. | Ø | Ud./Caja | €/Ud. |
|--------|-------------|----------|--------|
| 616604 | 20-1/2" | 100 | 13,03 |
| 616605 | 25-3/4" | 100 | 16,56 |
| 616152 | 32-1" | 60 | 24,80 |
| 616153 | 40 - 1 1/4" | 35 | 34,03 |
| 616154 | 50-1 1/2" | 30 | 34,88 |
| 616610 | 63-1 1/2" | 20 | 49,10 |
| 616155 | 63-2" | 20 | 44,71 |
| 616612 | 75-2 1/2" | 14 | 85,57 |
| 616613 | 90-3" | 6 | 106,66 |
| 616614 | 110-4" | 4 | 180,36 |
| 616664 | 125-4" | 4 | 199,86 |

Otras dimensiones de rosca,, bajo consulta.



Aplicación



UAM - TRANSICIONES ADAPTADOR HEMBRA PE-AD/LATÓN

PE 100 SDR11 Presión de servicio máxima admisible 16 bar (agua)/5 bar (gas)

| Ref. | Ø | Ud./Caja | €/Ud. |
|--------|-----------|----------|--------|
| 616615 | 20-1/2" | 150 | 10,14 |
| 616616 | 25-3/2" | 100 | 16,53 |
| 616156 | 32-1" | 60 | 19,33 |
| 616157 | 40-1 1/4" | 50 | 28,43 |
| 616158 | 50-1 1/2" | 35 | 32,49 |
| 616621 | 63-1 1/2" | 20 | 41,29 |
| 616159 | 63 - 2" | 20 | 41,13 |
| 616665 | 75-2 1/2" | 14 | 77,11 |
| 616623 | 90-3" | 10 | 86,30 |
| 616624 | 110-4" | 6 | 160,09 |
| 616666 | 125-4" | 6 | 165,46 |

Otras dimensiones de rosca,, bajo consulta.



Aplicación



EFL - PORTABRIDAS EMBRIDADAS
 PE 100 SDR11 Presión de servicio máxima
 admisible 16 bar (agua)/5 bar (gas)

| Ref. | Ø | Ud./Caja | €/Ud. |
|--------|----------|----------|--------|
| 615417 | 63/50 | 5 | 86,40 |
| 615418 | 90/80 | 5 | 94,84 |
| 615419 | 110/100 | 3 | 105,29 |
| 615605 | 125/100 | 2 | 120,44 |
| 615421 | 160/150 | 2 | 182,63 |
| 615927 | 180/150 | 2 | 213,66 |
| 615607 | 225/200* | 1 | 261,89 |

* Agujeros de brida para PN 10



Aplicación



RS -XL - ABRAZADERAS DE REPARACIÓN
 PE 100 SDR11 Presión de servicio máxima
 admisible 16 bar (agua)/10 bar (gas)

| Ref. | Ø | Ud./Caja | €/Ud. |
|--------|------|----------|----------|
| 616366 | 500 | 1 | 4.927,22 |
| 616367 | 560 | 1 | 5.214,70 |
| 616368 | 630 | 1 | 5.387,96 |
| 616369 | 710 | 1 | 5.586,27 |
| 616370 | 800 | 1 | 5.947,43 |
| 616371 | 900 | 1 | 6.278,31 |
| 616372 | 1000 | 1 | 6.460,96 |
| 616379 | 1200 | 1 | 6.772,00 |



Aplicación



SA - TOMAS SIMPLES

PE 100 SDR11 Presión de servicio máxima admisible 16 bar (agua)/10 bar (gas)

| Ref. | Ø | Ud./Caja | €/Ud. |
|--------|---------|----------|--------|
| 612757 | 63-32* | 20 | 37,02 |
| 612759 | 63-50* | 20 | 32,94 |
| 615020 | 75-50 | 15 | 39,31 |
| 615285 | 90-32 | 20 | 44,10 |
| 612819 | 90-63 | 20 | 39,52 |
| 615334 | 110-32 | 12 | 48,09 |
| 615031 | 110-50 | 12 | 45,28 |
| 612760 | 110-63 | 12 | 43,92 |
| 615411 | 110-90 | 12 | 68,82 |
| 615087 | 125-32 | 12 | 54,07 |
| 612761 | 125-63 | 12 | 50,51 |
| 615412 | 125-90 | 12 | 52,25 |
| 615584 | 125-110 | 10 | 62,11 |
| 612886 | 160-32 | 8 | 115,20 |

| Ref. | Ø | Ud./Caja | €/Ud. |
|--------|---------|----------|--------|
| 612762 | 160-63 | 6 | 96,90 |
| 615413 | 160-90 | 2 | 93,28 |
| 615739 | 160-110 | 2 | 105,16 |
| 615585 | 160-125 | 2 | 98,16 |
| 612763 | 180-63 | 6 | 59,67 |
| 615414 | 180-90 | 2 | 104,15 |
| 615948 | 180-110 | 2 | 106,21 |
| 615740 | 180-125 | 2 | 103,39 |
| 612764 | 200-63 | 5 | 56,17 |
| 612765 | 225-63 | 5 | 57,74 |
| 615415 | 225-90 | 5 | 101,55 |
| 616044 | 225-110 | 5 | 112,14 |
| 616045 | 225-125 | 4 | 124,05 |
| 616046 | 225-160 | 4 | 112,85 |

Las tomas simples SA pueden ser soldadas en tuberías SDR11 a SDR17,6

*Excepto las Ø 63 que solo pueden serlo con SDR11



Aplicación



SA-TL - TOMA SIMPLE SA-TL

PE 100 SDR11 Presión de servicio máxima admisible 16 bar (agua)/10 bar (gas)

| Ref. | Ø1 | Ø2 | Ø3 | Ud./Caja | €/Ud. |
|---------------|---------|----|----|----------|---------------|
| 615465 | 250/560 | 32 | 21 | 5 | 90,86 |
| 615466 | 250/560 | 63 | 47 | 5 | 100,16 |

Las tomas simples SA-TL pueden ser soldadas en tuberías SDR11 a SDR17,6



Aplicación



SA-XL - TOMA SIMPLE SA-XL

PE 100 SDR11 Presión de servicio máxima admisible 16 bar (agua)/10 bar (gas)

| Ref. | Ø1 | Ø2 | Ud./Caja | €/Ud. |
|---------------|-----|-----|----------|-----------------|
| 616469 | 400 | 225 | 1 | 7.859,75 |
| 616779 | 400 | 250 | 1 | 8.261,28 |
| 616780 | 450 | 225 | 1 | 7.859,75 |
| 616781 | 450 | 250 | 1 | 6.766,90 |
| 616391 | 500 | 225 | 1 | 6.897,00 |
| 616782 | 500 | 250 | 1 | 7.188,97 |
| 616783 | 500 | 280 | 1 | 7.515,16 |
| 616784 | 500 | 315 | 1 | 7.723,93 |
| 616392 | 560 | 225 | 1 | 6.304,38 |
| 616785 | 560 | 250 | 1 | 6.304,38 |
| 616786 | 560 | 280 | 1 | 6.304,38 |
| 616787 | 560 | 315 | 1 | 6.304,38 |
| 616788 | 560 | 355 | 1 | 6.721,90 |
| 616789 | 560 | 400 | 1 | 8.141,44 |
| 616393 | 630 | 225 | 1 | 6.408,77 |
| 616790 | 630 | 250 | 1 | 6.408,77 |
| 616791 | 630 | 280 | 1 | 6.408,77 |
| 616792 | 630 | 315 | 1 | 6.408,77 |
| 616793 | 630 | 355 | 1 | 6.813,47 |
| 616794 | 630 | 400 | 1 | 8.308,43 |
| 616394 | 710 | 225 | 1 | 6.554,89 |
| 616795 | 710 | 250 | 1 | 6.554,89 |
| 616796 | 710 | 280 | 1 | 6.554,89 |
| 616797 | 710 | 315 | 1 | 5.899,40 |
| 616798 | 710 | 355 | 1 | 6.275,16 |
| 616762 | 710 | 400 | 1 | 8.350,18 |
| 616395 | 800 | 225 | 1 | 6.554,89 |
| 616799 | 800 | 250 | 1 | 6.659,29 |
| 616800 | 800 | 280 | 1 | 6.659,29 |
| 616801 | 800 | 315 | 1 | 6.659,29 |

| Ref. | Ø1 | Ø2 | Ud./Caja | €/Ud. |
|---------------|------|-----|----------|------------------|
| 616802 | 800 | 355 | 1 | 7.076,80 |
| 616803 | 800 | 400 | 1 | 8.767,69 |
| 616396 | 900 | 225 | 1 | 6.926,48 |
| 616804 | 900 | 250 | 1 | 6.784,55 |
| 616805 | 900 | 280 | 1 | 6.784,55 |
| 616806 | 900 | 315 | 1 | 6.784,55 |
| 616807 | 900 | 355 | 1 | 7.306,41 |
| 616808 | 900 | 400 | 1 | 9.602,72 |
| 616397 | 1000 | 225 | 1 | 6.554,89 |
| 616809 | 1000 | 250 | 1 | 6.972,41 |
| 616810 | 1000 | 280 | 1 | 6.972,41 |
| 616811 | 1000 | 315 | 1 | 7.494,29 |
| 616812 | 1000 | 355 | 1 | 7.911,80 |
| 616813 | 1000 | 400 | 1 | 10.020,22 |
| 616384 | 1200 | 225 | 1 | 7.306,41 |
| 616814 | 1200 | 250 | 1 | 7.306,41 |
| 616815 | 1200 | 280 | 1 | 7.306,41 |
| 616816 | 1200 | 315 | 1 | 7.807,41 |
| 616817 | 1200 | 355 | 1 | 8.350,18 |
| 616818 | 1200 | 400 | 1 | 10.855,23 |

PE 100 SDR17 Presión de servicio máxima admisible 10 bar (agua)/5 bar (gas)

| Ref. | Ø1 | Ø2 | Ud./Caja | €/Ud. |
|---------------|------|-----|----------|-----------------|
| 616378 | 1000 | 160 | 1 | 6.179,14 |
| 616383 | 1200 | 160 | 1 | 6.596,64 |

* Para otras dimensiones consultar SA UNI



Aplicación

**SA-TL UNI- TOMAS SIMPLES SA-UNI**

PE 100 SDR11 Presión de servicio máxima admisible 16 bar (agua)/10 bar (gas)

| Ref. | Ø1 | Ø2 | Ud./Caja | €/Ud. |
|--------|-----------|-----|----------|--------|
| 616553 | 250-280 | 90 | 5 | 151,05 |
| 616554 | 250-280 | 110 | 5 | 164,45 |
| 616555 | 250-280 | 125 | 5 | 175,57 |
| 616556 | 250-280 | 160 | 5 | 160,24 |
| 616557 | 315-400 | 90 | 5 | 162,74 |
| 616558 | 315-400 | 110 | 5 | 155,39 |
| 616559 | 315-400 | 125 | 5 | 184,69 |
| 616560 | 315-400 | 160 | 5 | 150,34 |
| 616561 | 450-900 | 90 | 5 | 172,23 |
| 616562 | 450-900 | 110 | 5 | 159,06 |
| 616563 | 450-900 | 125 | 5 | 201,53 |
| 616564 | ● 450-900 | 160 | 5 | 185,71 |

Las tomas simples SA-TL-UNI pueden ser soldadas en tuberías SDR11 a SDR17,6



Aplicación

**DAA-TL - TOMAS EN CARGA TOP-LOADING CON DERIVACIÓN EXTRA LARGA**

PE 100 SDR11 Presión de servicio máxima admisible 16 bar (agua)/10 bar (gas)

| Ref. | Ø1 | Ø2 | Ø3 | Ud./Caja | €/Ud. |
|--------|--------------|----|----|----------|--------|
| 615527 | 080/130 | 50 | 50 | 20 | 187,25 |
| 615528 | 130/160 | 50 | 50 | 12 | 216,54 |
| 615531 | 160/210 | 63 | 50 | 5 | 221,29 |
| 615339 | 250/315(400) | 63 | 50 | 5 | 310,76 |

Las tomas en carga DAA-TL pueden ser soldadas en tubos SDR11 a SDR17,6 desde Ø 250 a Ø 315
Para tubos mayores a Ø 315 sólo en SDR17



Aplicación



DAA - TOMAS EN CARGA CON DERIVACIÓN EXTRA LARGA

*PE 100 SDR11 Presión de servicio máxima
admisible 16 bar (agua)/10 bar (gas)*

| Ref. | Ø1 | Ø2 | Ø3 | Ud./Caja | €/Ud. |
|--------|-----|----|----|----------|--------|
| 612630 | 40 | 20 | 50 | 30 | 45,09 |
| 616473 | 40 | 25 | 50 | 30 | 45,09 |
| 616474 | 40 | 32 | 50 | 30 | 41,31 |
| 616475 | 50 | 20 | 50 | 28 | 58,37 |
| 612702 | 50 | 25 | 50 | 28 | 56,10 |
| 615080 | 50 | 32 | 50 | 28 | 56,10 |
| 612631 | 63 | 20 | 50 | 20 | 59,58 |
| 612633 | 63 | 25 | 50 | 20 | 59,58 |
| 612632 | 63 | 32 | 50 | 20 | 47,02 |
| 616334 | 63 | 63 | 50 | 20 | 59,30 |
| 616482 | 75 | 32 | 50 | 24 | 68,54 |
| 616483 | 90 | 20 | 50 | 14 | 75,47 |
| 616484 | 90 | 25 | 50 | 14 | 69,21 |
| 612634 | 90 | 32 | 50 | 14 | 58,64 |
| 612701 | 90 | 63 | 50 | 14 | 61,21 |
| 616487 | 110 | 20 | 50 | 14 | 68,06 |
| 616488 | 110 | 25 | 50 | 14 | 68,06 |
| 612637 | 110 | 32 | 50 | 14 | 66,31 |
| 612624 | 110 | 63 | 50 | 14 | 64,97 |
| 616491 | 125 | 20 | 50 | 12 | 90,86 |
| 616492 | 125 | 25 | 50 | 12 | 90,86 |
| 612649 | 125 | 32 | 50 | 12 | 90,86 |
| 612309 | 125 | 63 | 50 | 12 | 85,72 |
| 616495 | 140 | 32 | 50 | 12 | 114,56 |
| 616496 | 140 | 63 | 50 | 12 | 118,46 |
| 616497 | 160 | 20 | 50 | 10 | 80,45 |
| 616498 | 160 | 25 | 50 | 10 | 80,45 |
| 612641 | 160 | 32 | 50 | 10 | 78,15 |
| 612650 | 160 | 63 | 50 | 10 | 78,32 |
| 616501 | 180 | 20 | 50 | 10 | 90,43 |
| 616502 | 180 | 25 | 50 | 10 | 90,43 |
| 612651 | 180 | 32 | 50 | 10 | 90,43 |
| 612652 | 180 | 63 | 50 | 10 | 90,43 |
| 612654 | 200 | 32 | 50 | 8 | 96,40 |
| 612659 | 200 | 63 | 50 | 8 | 92,81 |
| 612657 | 225 | 32 | 50 | 8 | 130,69 |
| 612655 | 225 | 63 | 50 | 8 | 130,69 |

Las tomas en carga DAA pueden ser soldadas en tuberías SDR11 a SDR17,6

*Excepto las ≤ DN 63 que solo pueden serlo con SDR11



Aplicación



DAV - TOMAS EN CARGA CON VÁLVULA DE CORTE INCORPORADA CON DERIVACIÓN EXTRA LARGA

PE 100 SDR11 Presión de servicio máxima admisible 16 bar (agua)/10 bar (gas)

| Ref. | Ø1 | Ø2 | Ud./Caja | €/Ud. |
|--------|-----|----|----------|--------|
| 615955 | 50* | 32 | 16 | 148,59 |
| 615341 | 63* | 32 | 16 | 133,65 |
| 615342 | 63* | 40 | 16 | 141,46 |
| 615956 | 75 | 32 | 12 | 156,20 |
| 615344 | 90 | 32 | 12 | 176,24 |
| 615346 | 90 | 50 | 12 | 178,53 |
| 615347 | 90 | 63 | 12 | 180,58 |
| 615348 | 110 | 32 | 10 | 165,92 |
| 615350 | 110 | 50 | 10 | 167,01 |
| 615351 | 110 | 63 | 10 | 170,26 |
| 615352 | 125 | 32 | 10 | 178,32 |
| 615354 | 125 | 50 | 10 | 178,70 |
| 615355 | 125 | 63 | 10 | 178,91 |
| 615930 | 140 | 63 | 6 | 183,25 |
| 615356 | 160 | 32 | 6 | 211,60 |
| 615358 | 160 | 50 | 6 | 210,55 |
| 615359 | 160 | 63 | 6 | 213,27 |
| 615361 | 180 | 32 | 5 | 213,51 |
| 615363 | 180 | 50 | 5 | 214,33 |
| 615364 | 180 | 63 | 5 | 214,57 |
| 615366 | 200 | 32 | 5 | 212,93 |
| 615368 | 200 | 50 | 5 | 249,54 |
| 615369 | 200 | 63 | 5 | 214,33 |
| 615374 | 225 | 32 | 5 | 211,85 |
| 615376 | 225 | 50 | 5 | 212,89 |
| 615377 | 225 | 63 | 5 | 212,89 |

Las tomas DAV pueden ser soldadas en tuberías SDR11 a SDR17,6

* Excepto las ≤ DN 63 que solo pueden serlo con SDR11



Aplicación



DAV-TL - TOMAS EN CARGA TOP LOADING CON VÁLVULA DE CORTE INCORPORADA CON DERIVACIÓN EXTRA LARGA

PE 100 SDR11 Presión de servicio máxima admisible 16 bar (agua)/10 bar (gas)

| Ref. | Ø1 | Ø2 | Ud./Caja | €/Ud. |
|--------|---------|----|----------|--------|
| 616464 | 250/315 | 50 | 10 | 256,42 |
| 616465 | 355/400 | 50 | 10 | 269,25 |

Las tomas DAV-TL pueden ser soldadas en tuberías SDR11 a SDR17,6



Aplicación



FIXBLOC - FIJACIÓN EN TUBERÍAS PARA ABSORBER FUERZAS DE EMPUJE Y TRACCIÓN AXIAL .

Uso universal en tubería de PE 100 (SDR33 hasta SDR11)

| Ref. | Ø | Ud./Caja | €/Ud. |
|--------|----------|----------|--------|
| 680600 | 160-1600 | 15 | 101,34 |



Aplicación



PUDDLE-FLANGE - COLLARÍN DE GOMA PARA PARED

De gran flexibilidad, para el sellado hidrostático de tuberías de plástico (PE, PP, PVC, ABS, PVDF, etc.) en estructuras de hormigón (5 bares hasta D315, 4 bares desde D355)

| Ref. | Ø | Ud./Caja | €/Ud. |
|-----------|------|----------|--------|
| 101100004 | 32 | 1 | 46,12 |
| 101100005 | 40 | 1 | 46,12 |
| 101100006 | 50 | 1 | 46,12 |
| 101100007 | 63 | 1 | 47,68 |
| 101100008 | 75 | 1 | 52,15 |
| 101100009 | 90 | 1 | 54,52 |
| 101100010 | 110 | 1 | 58,95 |
| 101100011 | 125 | 1 | 63,22 |
| 101100012 | 140 | 1 | 64,50 |
| 101100013 | 160 | 1 | 64,80 |
| 101100014 | 180 | 1 | 67,12 |
| 101100015 | 200 | 1 | 68,29 |
| 101100016 | 225 | 1 | 70,58 |
| 101100017 | 250 | 1 | 72,19 |
| 101100018 | 280 | 1 | 75,52 |
| 101100019 | 315 | 1 | 95,54 |
| 101100020 | 355 | 1 | 129,88 |
| 101100021 | 400 | 1 | 155,52 |
| 101100022 | 450 | 1 | 163,66 |
| 101100023 | 500 | 1 | 183,01 |
| 101100024 | 560 | 1 | 200,12 |
| 101100025 | 630 | 1 | 219,35 |
| 101100027 | 710 | 1 | 241,66 |
| 101100028 | 800 | 1 | 268,04 |
| 101100029 | 900 | 1 | 320,33 |
| 101100030 | 1000 | 1 | 376,47 |
| 101100031 | 1200 | 1 | 444,14 |



Aplicación



KH - VÁLVULAS DE BOLA EN PE-AD, ¼ DE VUELTA. PASO TOTAL.

PE 100 SDR11 Presión de servicio máxima admisible 16 bar (agua)/10 bar (gas)

| Ref. | Ø | Ud./Caja | €/Ud. |
|--------|-----|----------|--------|
| 616470 | 20 | 1 | 130,33 |
| 616471 | 25 | 1 | 130,33 |
| 616176 | 32 | 1 | 125,69 |
| 616177 | 40 | 1 | 98,72 |
| 616178 | 50 | 1 | 128,36 |
| 616179 | 63 | 1 | 169,57 |
| 616180 | 90 | 1 | 446,60 |
| 616181 | 110 | 1 | 491,25 |
| 616182 | 125 | 1 | 326,02 |



KHP-GAS - VÁLVULAS DE BOLA EN PE-AD, ¼ DE VUELTA PARA GAS. PASO REDUCIDO.

PE 100 SDR11 Presión de servicio máxima admisible 10 bar (gas)

| Ref. | Ø | Ud./Caja | €/Ud. |
|-----------|----|----------|--------|
| 612490GPL | 32 | 1 | 77,22 |
| 612494GPL | 63 | 1 | 170,69 |
| 612495GPL | 90 | 1 | 248,57 |



Aplicación



KHP - VÁLVULAS DE BOLA EN PE-AD, ¼ DE VUELTA. PASO REDUCIDO.

PE 100 SDR11 Presión de servicio máxima admisible 16 bar (agua)/10 bar (gas)

| Ref. | Ø | Ud./Caja | €/Ud. |
|--------|-----|----------|----------|
| 612490 | 32 | 1 | 72,48 |
| 612497 | 40 | 1 | 89,19 |
| 612492 | 50 | 1 | 125,22 |
| 612494 | 63 | 1 | 138,61 |
| 612495 | 90 | 1 | 207,12 |
| 612493 | 110 | 1 | 268,33 |
| 612496 | 125 | 1 | 317,64 |
| 612483 | 160 | 1 | 787,15 |
| 615309 | 180 | 1 | 752,06 |
| 612480 | 200 | 1 | 1.504,12 |
| 616186 | 225 | 1 | 1.532,17 |



Aplicación



NOVEDAD

FRIALOC - VALVULA EN PE-AD PARA AGUA. PASO TOTAL.

PE 100 SDR11 Presión de servicio máxima admisible 16 bar (agua)

| Ref. | Ø | Ud./Caja | €/Ud. |
|---------|-----|----------|----------|
| 616293 | 90 | 1 | 1.087,67 |
| 616294 | 110 | 1 | 1.087,67 |
| 616295 | 125 | 1 | 1.094,12 |
| 616296 | 160 | 1 | 1.710,17 |
| 616297 | 180 | 1 | 1.746,06 |
| 616453* | 200 | 1 | 2.111,63 |
| 616298* | 225 | 1 | 2.167,20 |
| 616438* | 250 | 1 | 2.273,74 |

*Para diámetros a partir de 200mm el paso está restringido a d180 mm



Aplicación



KHPV-GAS - VÁLVULAS DE ESFERA EN PE-AD, ¼ DE VUELTA, CON VENTEOS, PARA GAS. PASO REDUCIDO.

PE 100 SDR11 Presión de servicio máxima admisible 10 bar (gas)

| Ref. | Descripción | Ø - Venteos | Ud./Caja | €/Ud. |
|---------------------|-----------------|-------------|----------|---------------|
| KHP0VE063GPL | Sin venteos | 63-0VE | 1 | 264,35 |
| KHP1VE063GPL | Con un venteo | 63-1VE | 1 | 632,98 |
| KHP2VE063GPL | Con dos venteos | 63-2VE | 1 | 952,00 |



Aplicación



BS - SETS DE ACCIONAMIENTO PARA KH,KHP, AKHP Y AKHP-TL

PE 100 SDR11 Presión de servicio máxima admisible 16 bar (agua)/10 bar (gas)

| Ref. | Ø Tubo | Longitud (mm) | Ud./Caja | €/Ud. |
|---------------|--------|---------------|----------|---------------|
| 615741 | 20-50 | 0,45 - 0,70 | 1 | 101,83 |
| 615957 | 20-50 | 0,60 - 1,00 | 1 | 110,26 |
| 615328 | 20-50 | 0,60 - 1,00 | 1 | 104,66 |
| 616466 | 20-50 | 1,00 - 1,50 | 1 | 113,06 |
| 615330 | 20-50 | 1,00 - 1,50 | 1 | 113,06 |
| 616068 | 20-50 | 1,20 - 2,00 | 1 | 117,70 |
| 615329 | 20-50 | 1,20 - 2,00 | 1 | 115,78 |
| 615958 | 63-225 | 0,60 - 1,00 | 1 | 124,26 |
| 615310 | 63-225 | 0,60 - 1,00 | 1 | 117,61 |
| 616467 | 63-225 | 1,00 - 1,50 | 1 | 127,04 |
| 615331 | 63-225 | 1,00 - 1,50 | 1 | 127,04 |
| 616069 | 63-225 | 1,20 - 2,00 | 1 | 140,59 |
| 615311 | 63-225 | 1,20 - 2,00 | 1 | 139,69 |

Máquinas de soldadura
Rascadores
Accesorios y herramientas



Equipos y herramientas Friatools

INFRAESTRUCTURA





Más información



FRIAMAT BASIC ECO
MÁQUINA UNIVERSAL DE SOLDADURA
SIN FUNCIÓN DE DOCUMENTACIÓN

| Ref. | Descripción | €/Ud. |
|---------------|---|-----------------|
| 613120 | Friamat basic eco con lápiz lector de código de barras | 3,629.69 |
| 614120 | FRIAMAT basic eco 2D | 5,369.04 |
| 611120 | Friamat basic eco con mini escáner lector de código de barras | 4,180.58 |

Unidad de fusión universal para la unión de accesorios de DN 20 a DN 900. Compartimento de almacenamiento para accesorios, opción de lector código de barras o escáner para el reconocimiento de códigos de barras. Teclado de fácil manejo. Selección de idiomas, volumen de timbre ajustable, e introducción manual de notas.

Cable de conexión (4 m) y cable de red (5 m) extra largos. Peso aproximado 18 kg.

Suministrado en una práctica caja de aluminio de protección para el transporte.



FRIAMAT PRIME ECO
MÁQUINA UNIVERSAL DE
SOLDADURA CON FUNCIÓN DE
DOCUMENTACIÓN Y TRAZABILIDAD

| Ref. | Descripción | €/Ud. |
|----------------|---|-----------------|
| 613124 | Friamat prime eco con lápiz lector de código de barras | 4,519.15 |
| 614124 | FRIAMAT prime eco 2D | 5,485.41 |
| 611124* | Friamat prime eco con mini escáner lector de código de barras | 4,729.39 |

Unidad de fusión para la soldadura mediante accesorios de electrofusión de tubos de cualquier tamaño (hasta DN 900). Fácil guía de usuario con un gran display, maxi-guía y modernos interfaces: Puertos USB (A + B) para la transmisión de datos a través de tarjeta de memoria FRIATEC (incluida); para la conexión de impresoras, volcado de datos y de documentos PDF.

Puerto paralelo para conexión a impresora y PC.

Contraseña de supervisor para el ajuste individual de las funciones del dispositivo.

Posibilidad de introducir coordenadas GPS, e introducir información a través de textos de código de barras, con lápiz lector o escáner de código de barras (opcional).

Selección de idiomas, volumen de timbre ajustable, e introducción manual de notas. Cable de conexión (4 m) y cable de red (5 m) extra largos.

Peso aproximado 18 kg.

Suministrado en una práctica caja de aluminio de protección para el transporte.

* Consultar promociones vigentes para modelo "FRIAMAT prime eco con mini escáner"

App en castellano disponible

AVAILABLE ON THE Google Play

AVAILABLE ON THE App Store





FRIAMAT PRINT ECO
MÁQUINA UNIVERSAL DE SOLDADURA
CON FUNCIÓN DE DOCUMENTACIÓN

| Ref. | Descripción | €/Ud. |
|---------------|---|-----------------|
| 613122 | Friamat print eco con lápiz lector de código de barras | 4,405.35 |
| 611122 | Friamat print eco con mini escáner lector de código de barras | 4,598.15 |

Unidad de fusión universal para la unión de accesorios de DN20 a DN1200.

Puerto USB para la transmisión de datos para la conexión a impresora de datos y de documentación PDF

Selección de idiomas, volumen de timbre ajustable e introducción manual de notas. Cable de conexión (4 m) y cable de red (5 m) extra largos.

Peso aproximado 18 kg.

Suministrada en una práctica caja de aluminio de protección para el transporte



FRIAMAT 7 PRIME

| Ref. | Descripción | €/Ud. |
|----------------|-----------------------------------|-----------------|
| 613134 | FRIAMAT 7 Gen. prime | 5,529.18 |
| 611134* | FRIAMAT 7 Gen. prime Mini Escaner | 5,780.48 |
| 614134 | FRIAMAT 7 Gen. prime 2D | 6,489.63 |

FRIAMAT prime ofrece una gran cantidad de funciones digitales para la documentación y la trazabilidad, gracias a la nueva interfaz Bluetooth en combinación con la aplicación FRIAMAT. Con el escáner 1D/2D opcional, la nueva generación de FRIAMAT también está preparada para leer y procesar códigos de barras 2D según ISO 12176-5.

Su pantalla de alto brillo y contraste es fácil de leer, tanto en días soleados como en días oscuros y lluviosos.

Convierte tu teléfono en el centro de control de todo lo relacionado con la soldadura. Simplemente conecta tu unidad FRIAMAT prime a la aplicación FRIAMAT APP a través de Bluetooth. Después podrás controlar el proceso de fusión con tu teléfono. Los datos del proceso de fusión se transfieren automáticamente a la aplicación.

* Consultar promociones vigentes para modelo "FRIAMAT 7 Gen. prime Mini Escaner"



FRIAMAT 7 BASIC

| Ref. | Descripción | €/Ud. |
|---------------|-----------------------------------|-----------------|
| 613130 | FRIAMAT 7 Gen. Basic | 5,406.39 |
| 611130 | FRIAMAT 7 Gen. basic Mini Escaner | 5,585.99 |
| 614130 | FRIAMAT 7 Gen. basic 2D | 6,366.84 |

FRIAMAT basic es nuestro modelo básico por excelencia, cada vez con más prestaciones: refrigeración activa con flujo optimizado, carcasa robusta, pantalla gráfica de alta calidad, interfaz de usuario intuitiva y mucho más.



NUEVO ESCÁNER LECTOR DE CÓDIGOS DE BARRAS

| Ref. | Descripción | €/Ud. |
|---------------|--------------|---------------|
| 624005 | Mini escáner | 606,63 |



FWLESST - LÁPIZ LECTOR DE CÓDIGO DE BARRAS

| Ref. | Descripción | €/Ud. |
|-----------------|--------------|---------------|
| 623645 ● | Lápiz lector | 424,54 |

Lápiz lector de códigos de barras FRIAMAT apto para leer los códigos de soldadura y de trazabilidad.
 Apto para todos los equipos de soldadura FRIAMAT.



CONTACT 4 - BORNES DE CONEXIÓN DE 4,0 MM

| Ref. | Descripción | €/Par. |
|---------------|------------------|--------------|
| 624529 | Bornes de 4,0 mm | 94,10 |

Para la conexión al accesorio de soldadura en toda nuestra gama FRIAMAT.
 Estos conectores se venden por unidad.



ADBK - ADAPTADORES PARA BORNES DE 4,7 MM

| Ref. | Descripción | €/Par |
|---------------|-----------------------|---------------|
| 613237 | Adaptadores de bornes | 180,39 |

Adaptador para bornes de 4,7 mm para cualquier tipo de FRIAMAT.
 Estos conectores se venden por pares.



ALTK (FMT) - CAJA DE ALUMINIO PARA TRANSPORTE

| Ref. | Descripción | €/Ud. |
|---------------|--|---------------|
| 627600 | Caja de transporte para nuevas FRIAMAT prime / basic | 521,17 |
| 627001 | Caja de transporte para antiguas FRIAMAT prime / basic | 521,17 |
| 627001 | Caja de transporte para FRIAMAT prime eco / basic eco | 521,17 |
| 613302 | Caja de transporte para FRIAMAT XL | 642,18 |

Para el transporte y el almacenamiento de equipos de soldadura FRIAMAT. Otras cajas de transporte para equipos más antiguos FRIAMAT (I-II) bajo consulta.



FWGS 63 - RASCADOR PARA TUBOS DESDE DN 20 HASTA DN 63

| Ref. | Descripción | €/Ud. |
|---------------|-----------------------------------|-----------------|
| 613408 | Rascador para tubos DN 20 a DN 63 | 1.800,05 |

Para eliminar de forma segura la capa de óxido de las tuberías de HDPE y PE-XA.
Cuchilla extra ancha de metal duro.
Incluye 1 cuchilla de repuesto.
Suministrado en una práctica caja de aluminio de protección para el transporte.



FWGS 225 - RASCADOR PARA TUBOS DESDE DN 75 HASTA DN 400

| Ref. | Descripción | €/Ud. |
|---------------|------------------------------------|-----------------|
| 613410 | Rascador para tubos DN 75 a DN 400 | 2.527,86 |

Para eliminar de forma segura la capa de óxido de las tuberías de HDPE y PE-XA.
Cuchilla extra ancha de metal duro.
Incluye 1 cuchilla de repuesto.
Suministrado en una práctica caja de aluminio de protección para el transporte.



FWSG 710 L - RASCADOR PARA TUBOS DESDE DN 250 HASTA DN 710

| Ref. | Descripción | €/Ud. |
|---------------|-------------------------------------|-----------------|
| 613642 | Rascador para tubos DN 250 a DN 710 | 4.573,11 |

Para eliminar de forma segura la capa de óxido de las tuberías de HDPE y PE-Xa a la mitad o completo. Rascador de gran longitud. Cuchilla con hoja de carburo para una larga duración y rascado uniforme. Suministrado en una práctica caja de aluminio de protección para el transporte



FWSG 710 S - RASCADOR PARA TUBOS DESDE DN 250 HASTA DN 710 Y ACCESORIOS A TOPE

| Ref. | Descripción | €/Ud. |
|---------------|---|-----------------|
| 613639 | Rascador para tubos DN 250 a DN 710 y accesorios a tope | 4.573,11 |

Para eliminar de forma segura la capa de óxido de las tuberías de HDPE y PE-Xa a la mitad o completo y para el rascado seguro de piezas y tubos que van a ser soldados a testa. Rascador de gran longitud. Cuchilla con hoja de carburo para una larga duración y rascado uniforme. Suministrado en una práctica caja de aluminio de protección para el transporte.



WSG 900 L - RASCADOR PARA TUBOS DESDE DN 630 HASTA DN 900

| Ref. | Descripción | €/Ud. |
|---------------|---|------------------|
| 613644 | Rascador para tubos desde DN 630 a DN 900 | 10.281,39 |

Para eliminar de forma segura la capa de óxido de las tuberías de HDPE y PE-Xa a la mitad o completo y para el rascado seguro de piezas y tubos que van a ser soldados a testa. Rascador de gran longitud. Cuchilla con hoja de carburo para una larga duración y rascado uniforme. Suministrado en una práctica caja de aluminio de protección para el transporte.

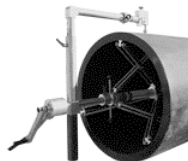

FWSG XL - RASCADOR PARA TUBOS DESDE DN 800 HASTA DN 1200

| Ref. | Descripción | €/Ud. |
|---------------|--------------------------------------|------------------|
| 613645 | Rascador para tubos DN 800 a DN 1200 | 25.298,06 |

Para eliminar de forma segura la capa de óxido en las tuberías de PE-AD en diámetros desde 800 a 1200, SDR11 - SDR33. Diseño modular para un fácil manejo y rápida instalación. Ajuste rápido y seguro al ancho del tubo. Montaje central, accionamiento mediante manivela. Compensación automática de la ovalidad de tubería y tolerancias mediante una cuchilla alojada en muelle móvil. Cuchilla reversible para doblar la duración. Suministrado en una práctica caja de aluminio de protección para el transporte.



FWSG 63 - RASCADOR PARA TUBOS DESDE DN 63 A DN 315

| Ref. | Ø | Descripción | €/Ud. |
|--------|--------|-------------|----------|
| 613562 | DN 63 | FWSG SE 63 | 1.573,03 |
| 613563 | DN 75 | FWSG SE 75 | 1.608,89 |
| 613564 | DN 90 | FWSG SE 90 | 1.663,83 |
| 613565 | DN 110 | FWSG SE 110 | 1.690,35 |
| 613566 | DN 125 | FWSG SE 125 | 1.864,92 |
| 613567 | DN 140 | FWSG SE 140 | 1.957,44 |
| 613568 | DN 160 | FWSG SE 160 | 1.864,92 |
| 613569 | DN 180 | FWSG SE 180 | 2.114,66 |
| 613570 | DN 200 | FWSG SE 200 | 2.173,52 |
| 613571 | DN 225 | FWSG SE 225 | 2.236,84 |
| 613572 | DN 250 | FWSG SE 250 | 2.331,96 |
| 613573 | DN 280 | FWSG SE 280 | 2.380,33 |
| 613574 | DN 315 | FWSG SE 315 | 2.450,78 |

Rascador para extremos de tubos y tomas simples y en carga. Dimensionado para cada diámetro para un raspado seguro y libre de óxido. Se usa en tuberías PE-AD y PE-XA.

Cuchillas reversibles para doblar la duración. Fácil fijación gracias al diseño de apertura y cierre.

Suministrado en una práctica caja de aluminio de protección para el transporte.



PFSP - SPRAY DE ACEITE PARA EL MANTENIMIENTO DE LOS RASCADORES DE FRIATEC

| Ref. | Descripción | €/Ud. |
|--------|--------------------------------|-------|
| 613301 | Spray de mantenimiento FRIATEC | 36,33 |

Para la limpieza y el mantenimiento de rascadores. Contenido 100 ml. Observe con atención las instrucciones de seguridad y utilización indicadas en el recipiente del spray de mantenimiento, y a las pertinentes instrucciones de uso de las rascadores.



FWSG RA - CUCHILLAS DE REPUESTO PARA RASCADORES

| Ref. | Descripción | €/Ud. |
|-------------------|---|---------------|
| 613322 (1) | FWSGE 3. Cuchillas para FWSG 225/315 Y FWSGA. Pintadas de color rojo | 362,60 |
| 613323 (1) | FWSGE 4. Cuchillas para FWSG 63. Pintadas de color verde | 364,25 |
| 613324 (1) | FWSGE 5. Cuchillas para FWSG 710 L/S / FWSG 900 L. Pintadas de color azul | 367,31 |
| 613325 (2) | FWSGE 6. Cuchillas para FWSGS 110 / FWSGS 180 | 368,42 |
| 613326 (2) | FWSGE 7. Cuchillas para FWSGS 225 | 370,43 |

(1) Integrado por 3 unidades de cuchillas de repuesto, 1 tornillo de cabeza de estrella y 1 llave cabeza estrella.

(2) Integrado por 1 unidad de cuchillas de repuesto, 2 tornillos de cabeza de estrella y 1 llave cabeza estrella.



| Ref. | Descripción | €/Ud. |
|-------------------|--|---------------|
| 613327 (3) | FWSGE 8. Cuchillas para FWSG SE (todos los DN) | 251,69 |

(3) Integrado por 1 unidad de cuchillas de repuesto, 1 tornillo de cabeza de estrella y 1 llave cabeza estrella.



| Ref. | Descripción | €/Ud. |
|-------------------|--|---------------|
| 613329 (4) | FWSGE 10. Cuchillas para FWSG RA 32 y 40 | 171,25 |
| 613330 (4) | FWSGE 11. Cuchillas para FWSG RA 50 y 63 | 172,09 |

(4) Integrado por 1 unidad de cuchillas de repuesto, 1 tornillo de cabeza de estrella y 1 llave cabeza estrella.



| Ref. | Descripción | €/Ud. |
|-------------------|----------------------------------|---------------|
| 613331 (5) | FWSGE 12. Cuchillas para FWSG XL | 695,04 |

(5) Integrado por 1 unidad de cuchillas de repuesto, 1 placa de deslizamiento. 2 tornillos de cabeza de estrella y 1 llave cabeza de estrella.

Cuchillas de repuesto de metal duro (alta estabilidad, larga duración)



ALTK (FWSG) - CAJA DE ALUMINIO PARA EL TRANSPORTE DE LOS RASCADORES FRIATEC

| Ref. | Descripción | €/Ud. |
|--------|------------------------|--------|
| 613307 | ALTK FWSG 63 | 87,86 |
| 613309 | ALTK FWSG 225 Y 63/225 | 211,92 |
| 613308 | ALTK FWSG 710 S | 400,46 |
| 613314 | ALTK FWSG 710 L | 400,46 |
| 613304 | ALTK FWSG 900 L | 426,75 |
| 613303 | ALTK FWSG SE 63 | 202,58 |
| 613319 | ALTK FWSG SE 75-140 | 226,50 |
| 613318 | ALTK FWSG SE 160 | 233,51 |
| 613320 | ALTK FWSG SE 250-315 | 342,70 |

Para transportar y almacenar rascadores.



FWZ - RASCADOR MANUAL

| Ref. | Descripción | €/Ud. |
|--------|-----------------------------|-------|
| 613300 | Rascador manual | 50,88 |
| 613270 | Cuchillas de repuesto 1 ud. | 37,27 |

Para la eliminación de la capa de óxido de las tuberías de PE – AD y accesorios, así como para desbarbar el canto cortado.

Cuchillas de repuesto en pack de 5 uds.



FWZ - RASCADOR MANUAL

| Ref. | Descripción | €/Ud. |
|--------|------------------------|--------|
| 613299 | Rascador manual gran Ø | 256,53 |

Para eliminar la capa de óxido de tubos de PE de gran diámetro, que no pueden ser rascados con rascadores convencionales.

Sirve especialmente para la preparación de las superficies de unión con tomas simples del tipo FRIALEN XL. También es apto para quitar las rebabas de bordes cortados.

Dispone de dos superficies de corte.



FRIATOP - DISPOSITIVO DE FIJACIÓN (TOP LOADING)

| Ref. | Descripción | €/Ud. |
|--------|-------------------------|----------|
| 613350 | Dispositivo Top Loading | 3.324,41 |

Dispositivo de fijación, presión y colocación para el montaje de las tomas simples y en carga FRIALEN Top Loading. No requiere fijación inferior. Accionamiento con muelle neumático extra elástico para una óptima presión durante el proceso de fusión.



PRESSKO - ÉMBOLO PARA LAS TOMAS EN CARGA FRIALEN XL Y SA-XL

| Ref. | Dimensión émbolo | Descripción | €/Ud. |
|--------|------------------|---------------------------|----------|
| 613821 | DN 160 | Émbolo para FRIALEN SA-XL | 536,36 |
| 613822 | DN 225 | Émbolo para FRIALEN SA-XL | 676,54 |
| 613823 | DN 250 | Émbolo para FRIALEN SA-XL | 778,54 |
| 613853 | DN 280 | Émbolo para FRIALEN SA-XL | 1.028,52 |
| 613854 | DN 315 | Émbolo para FRIALEN SA-XL | 1.130,90 |
| 613855 | DN 355 | Émbolo para FRIALEN SA-XL | 1.198,45 |
| 613837 | DN 400 | Émbolo para FRIALEN SA-XL | 2.780,78 |

Émbolo de fijación y conexión del Vacuset XL con salida DN 160 a DN 400



FWAB XL - BROCA DE PERFORACIÓN FWAB XL PARA SA-XL

| Ref. | Descripción | DN de la salida | €/Ud. |
|--------|-------------------|-----------------|----------|
| 613832 | FWAB XL 90 | DN 90 | 2.299,87 |
| 613833 | FWAB XL 110 | DN 110 | 2.379,87 |
| 613834 | FWAB XL 125 | DN 125 | 2.448,44 |
| 613829 | FWAB XL 160 SDR11 | DN 160 | 2.614,14 |
| 613838 | FWAB XL 160 SDR17 | DN 160 | 2.914,13 |
| 613830 | FWAB XL 225 | DN 225 | 2.928,42 |
| 613831 | FWAB XL 250 | DN 250 | 3.251,25 |
| 613850 | FWAB XL 280 | DN 280 | 3.931,19 |
| 613851 | FWAB XL 315 | DN 315 | 4.171,20 |
| 613852 | FWAB XL 355 | DN 355 | 4.171,20 |
| 613836 | FWAB XL 400 | DN 400 | 4.190,23 |

FWAB XL para la perforación de tubos de PE-AD. Con sistema de despresurización a través de la salida de los accesorios SA-XL. Consistente en una sierra cortante del DN elegido, un adaptador SDS max, extensión para el adaptador, broca central y cavidad para alojamiento de la viruta. Se debe utilizar un taladro eléctrico. Se entrega en un maletín de aluminio.



UNITOP - DISPOSITIVO DE FIJACIÓN PARA LAS TOMAS SIMPLES SA-UNI

| Ref. | Descripción | €/Ud. |
|--------|---|----------|
| 613385 | Dispositivo de fijación para tomas simples Frialen SA-UNI | 5.713,96 |
| 613241 | Adaptadores en ángulo para conexiones por socket 4.0 mm | 76,58 |

Dispositivo de fijación para las tomas de derivación simple SA-UNI DN 250 a DN 710 con salidas DN 90, DN110, DN 125 y DN 160. Se suministra en un maletín de aluminio.

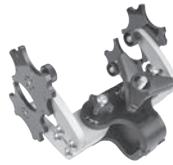

CLAMP 63 - ALINEADOR PARA TUBOS DESDE DN 20 HASTA DN 63

| Ref. | Descripción | €/Ud. |
|---------------|---|---------------|
| 613020 | Alineador para tubos DN 20 a DN63 | 579,90 |
| 613034 | Alineador para tubos DN 32 a DN63 para instalación con FRIALONG | 917,59 |

Alineador universal con ajuste de ángulo (45° y 90°), para manguitos, reducciones y salidas en accesorios de toma de derivación electrosoldable desde DN 20 a DN 63.

Opcional: versión CLAMP63L para instalaciones de manguitos extra largos FRIALONG.



CLAMP 180 - ALINEADOR PARA TUBOS DESDE DN 63 HASTA DN 180

| Ref. | Descripción | €/Ud. |
|---------------|--|-----------------|
| 613021 | Alineador con dos elementos fijadores | 1.425,18 |
| 613022 | Elemento fijador adicional | 284,31 |
| 613023 | Set de medias lunas reductoras DN 110-DN 160 | 99,75 |
| 613024 | Extensión en forma de Té | 1.121,88 |

Alineador con ajuste de ángulo (45° y 90°), y dos elementos fijadores para manguitos, reducciones y codos de DN 63, DN 90, DN 125 y DN180.

Se pueden acoplar medias lunas reductoras para crear diferentes configuraciones. Se suministra en una práctica bolsa.

El alineador se puede expandir con elementos fijadores adicionales para uso cuádruple de DN 63, DN 90, DN 125 y DN 160. Se necesitarían dos alineadores adicionales.

Disponible elemento de extensión en Té para fijación y alineación. Variante con un solo alineador. Elementos fijadores adicionales pueden acoplarse para fijación doble en acometidas.

Medias lunas de reducción para DN 110 y DN 160. Se necesita un juego de media luna para cada elemento fijador.



SQM 63 Y 125 - PINZADOR PARA TUBOS DESDE DN 20 HASTA DN 125

| Ref. | Descripción | DN | SDR | €/Ud. |
|-----------------|-----------------|----------------|----------|---------------|
| 613025 ● | Pinzador SQM 63 | DN 20 a DN 63 | SDR 11 | 270,31 |
| 613026 | Pinzador SQM125 | DN 63 a DN 90 | SDR 11 | 641,31 |
| 613026 | Pinzador SQM125 | DN 90 a DN 125 | SDR 17,6 | 641,31 |

Pinzador para corte temporal en tubos de PE-AD y PE-Xa en DN 63 a DN 125 en SDR 11 y SDR 17,6.

Cumple con la DVGW GW 332.



VACUPUMP - BOMBA DE VACÍO PARA UTILIZACIÓN EN OBRA PARA SA-XL Y RS-XL

| Ref. | Descripción | €/Ud. |
|---------------|----------------------|-----------------|
| 613827 | Bomba de vacío 230 V | 3.798,77 |

Para la instalación de derivaciones Frialen XL SA-XL y abrazaderas de reparación RS-XL.
 Se compone de bomba de vacío (110 V/230 V)manómetro y mangueras de conexión.
 No requiere compresor adicional para su funcionamiento.
 Se suministra en un maletín de aluminio.



SQH 180 - PINZADOR HIDRÁULICO PARA TUBOS DESDE DN 63 HASTA DN 180

| Ref. | Descripción | DN | SDR | €/Ud. |
|---------------|-----------------|----------------|-------------------|-----------------|
| 613028 | Pinzador SQH180 | DN 63 a DN 180 | SDR 11 Y SDR 17,6 | 1.676,17 |

Pinzador para corte temporal en tubos de PE-AD y PE-Xa en DN 63 a DN 125 en SDR 11 y SDR 17,6.
 Cumple con la DVGW GW 332.



PRODUCTOS LIMPIADORES DE ÓXIDO ESPECÍFICOS PARA POLIETILENO

| Ref. | Descripción | €/Ud. |
|---------------|----------------------------|--------------|
| 614001 | Bote limpiador 0,75 Litros | 31,65 |
| 614002 | Toallitas limpiadoras | 40,60 |

Producto específico para una óptima limpieza y desoxidación del PE.
 Alta volatilidad, 99,9% alcohol.

Accesorios de PE



Accesorios de Polietileno inyectados largos

INFRAESTRUCTURA



**RDPE - REDUCCIÓN**

Con cuello largo para soldar con accesorios de alta seguridad FRIALEN, o soldadura a tope.

PE 100 SDR11 - Máxima presión de trabajo permitida 16 bar (agua) / 10 bar (gas)



Aplicación



| Ref. | Ø | €/Ud. |
|--------------|---------|-------|
| RDPE11003225 | 32-25 | 3,42 |
| RDPE11004020 | 40-20 | 5,00 |
| RDPE11004025 | 40-25 | 5,00 |
| RDPE11004032 | 40-32 | 5,00 |
| RDPE11005025 | 50-25 | 5,30 |
| RDPE11005032 | 50-32 | 5,81 |
| RDPE11005040 | 50-40 | 5,81 |
| RDPE11006332 | 63-32 | 8,03 |
| RDPE11006340 | 63-40 | 8,03 |
| RDPE11006350 | 63-50 | 8,03 |
| RDPE11007540 | 75-40 | 12,27 |
| RDPE11007550 | 75-50 | 21,89 |
| RDPE11007563 | 75-63 | 21,89 |
| RDPE11009050 | 90-50 | 15,86 |
| RDPE11009063 | 90-63 | 15,86 |
| RDPE11009075 | 90-75 | 15,86 |
| RDPE11011063 | 110-63 | 19,03 |
| RDPE11011075 | 110-75 | 19,03 |
| RDPE11011090 | 110-90 | 17,09 |
| RDPE11012563 | 125-63 | 27,00 |
| RDPE11012575 | 125-75 | 27,00 |
| RDPE11012590 | 125-90 | 27,00 |
| RDPE11125110 | 125-110 | 27,00 |
| RDPE11014075 | 140-75 | 36,96 |
| RDPE11014090 | 140-90 | 36,96 |
| RDPE11140110 | 140-110 | 36,96 |
| RDPE11140125 | 140-125 | 36,96 |
| RDPE11016090 | 160-90 | 52,01 |
| RDPE11160110 | 160-110 | 52,01 |
| RDPE11160125 | 160-125 | 52,01 |
| RDPE11160140 | 160-140 | 52,01 |

| Ref. | Ø | €/Ud. |
|--------------|---------|----------|
| RDPE11180125 | 180-125 | 58,15 |
| RDPE11180160 | 180-160 | 63,26 |
| RDPE11200125 | 200-125 | 63,91 |
| RDPE11200160 | 200-160 | 61,41 |
| RDPE11225110 | 225-110 | 118,08 |
| RDPE11225160 | 225-160 | 118,08 |
| RDPE11225180 | 225-180 | 118,08 |
| RDPE11250160 | 250-160 | 160,46 |
| RDPE11250180 | 250-180 | 167,92 |
| RDPE11250200 | 250-200 | 167,92 |
| RDPE11250225 | 250-225 | 167,92 |
| RDPE11280180 | 280-180 | 208,67 |
| RDPE11280200 | 280-200 | 208,67 |
| RDPE11280225 | 280-225 | 208,67 |
| RDPE11280250 | 280-250 | 200,96 |
| RDPE11315225 | 315-225 | 287,79 |
| RDPE11315250 | 315-250 | 287,79 |
| RDPE11315280 | 315-280 | 287,79 |
| RDPE11355250 | 355-250 | 605,25 |
| RDPE11355280 | 355-280 | 605,25 |
| RDPE11355315 | 355-315 | 605,25 |
| RDPE11400280 | 400-280 | 641,32 |
| RDPE11400315 | 400-315 | 641,32 |
| RDPE11400355 | 400-355 | 641,32 |
| RDPE11450400 | 450-400 | 690,35 |
| RDPE11500355 | 500-355 | 826,50 |
| RDPE11500400 | 500-400 | 861,02 |
| RDPE11500450 | 500-450 | 930,10 |
| RDPE11630400 | 630-400 | 1.310,29 |
| RDPE11630450 | 630-450 | 1.339,64 |
| RDPE11630500 | 630-500 | 1.346,70 |

Para otras medidas, diámetros y tipo de accesorios, consultar.



Aplicación



PE 100 SDR17 - Máxima presión de trabajo permitida 10 bar (agua) / 5 bar (gas)

| Ref. | Ø | €/U.. |
|--------------|---------|--------|
| RDPE17007540 | 75-40 | 12,27 |
| RDPE17007563 | 75-63 | 15,60 |
| RDPE17009050 | 90-50 | 16,92 |
| RDPE17009063 | 90-63 | 16,92 |
| RDPE17009075 | 90-75 | 16,92 |
| RDPE17011063 | 110-63 | 14,82 |
| RDPE17011075 | 110-75 | 14,82 |
| RDPE17011090 | 110-90 | 12,60 |
| RDPE17012563 | 125-63 | 27,00 |
| RDPE17012575 | 125-75 | 27,00 |
| RDPE17012590 | 125-90 | 27,00 |
| RDPE17125110 | 125-110 | 27,00 |
| RDPE17014075 | 140-75 | 38,79 |
| RDPE17014090 | 140-90 | 38,79 |
| RDPE17140110 | 140-110 | 38,79 |
| RDPE17140125 | 140-125 | 38,79 |
| RDPE17016090 | 160-90 | 52,01 |
| RDPE17160110 | 160-110 | 52,01 |
| RDPE17160125 | 160-125 | 52,01 |
| RDPE17160140 | 160-140 | 52,01 |
| RDPE17180125 | 180-125 | 58,15 |
| RDPE17180160 | 180-160 | 63,26 |
| RDPE17200125 | 200-125 | 54,48 |
| RDPE17200160 | 200-160 | 49,71 |
| RDPE17225110 | 225-110 | 118,08 |
| RDPE17225160 | 225-160 | 118,08 |
| RDPE17225180 | 225-180 | 118,08 |

| Ref. | Ø | €/Ud. |
|--------------|---------|----------|
| RDPE17250160 | 250-160 | 167,92 |
| RDPE17250180 | 250-180 | 167,92 |
| RDPE17250200 | 250-200 | 167,92 |
| RDPE17250225 | 250-225 | 167,92 |
| RDPE17280180 | 280-180 | 208,67 |
| RDPE17280200 | 280-200 | 208,67 |
| RDPE17280225 | 280-225 | 208,67 |
| RDPE17280250 | 280-250 | 200,96 |
| RDPE17315225 | 315-225 | 287,79 |
| RDPE17315250 | 315-250 | 287,79 |
| RDPE17315280 | 315-280 | 287,79 |
| RDPE17355250 | 355-250 | 641,32 |
| RDPE17355280 | 355-280 | 641,32 |
| RDPE17355315 | 355-315 | 377,44 |
| RDPE17400280 | 400-280 | 677,64 |
| RDPE17400315 | 400-315 | 677,64 |
| RDPE17400355 | 400-355 | 586,81 |
| RDPE17450315 | 450-315 | 714,10 |
| RDPE17450355 | 450-355 | 743,06 |
| RDPE17450400 | 450-400 | 784,04 |
| RDPE17500355 | 500-355 | 923,59 |
| RDPE17500400 | 500-400 | 975,37 |
| RDPE17500450 | 500-450 | 1.027,21 |
| RDPE17630400 | 630-400 | 1.261,81 |
| RDPE17630450 | 630-450 | 1.318,31 |
| RDPE17630500 | 630-500 | 1.337,58 |

WWPE - CODO 30°

Con cuello largo para soldar con accesorios de alta seguridad FRIALEN, o soldadura a tope.



Aplicación



PE 100 SDR11 - Máxima presión de trabajo permitida 16 bar (agua) / 10 bar (gas)

| Ref. | Ø | €/Ud. |
|-------------|-----|--------|
| WWPE1100075 | 75 | 25,43 |
| WWPE1100090 | 90 | 37,05 |
| WWPE1100110 | 110 | 54,84 |
| WWPE1100125 | 125 | 90,09 |
| WWPE1100140 | 140 | 98,65 |
| WWPE1100160 | 160 | 126,13 |
| WWPE1100180 | 180 | 180,69 |
| WWPE1100200 | 200 | 226,89 |
| WWPE1100225 | 225 | 282,18 |

PE 100 SDR17 - Máxima presión de trabajo permitida 10 bar (agua) / 5 bar (gas)

| Ref. | Ø | €/Ud. |
|-------------|-----|--------|
| WWPE1700075 | 75 | 24,73 |
| WWPE1700090 | 90 | 31,13 |
| WWPE1700110 | 110 | 40,53 |
| WWPE1700125 | 125 | 63,40 |
| WWPE1700140 | 140 | 82,04 |
| WWPE1700160 | 160 | 92,48 |
| WWPE1700180 | 180 | 130,62 |
| WWPE1700200 | 200 | 144,21 |
| WWPE1700225 | 225 | 184,40 |

Para otras medidas, diámetros y tipo de accesorios, consultar.



Aplicación



HDPE - CODO 45°

Con cuello largo para soldar con accesorios de alta seguridad FRIALEN, o soldadura a tope.

PE 100 SDR11 - Máxima presión de trabajo permitida 16 bar (agua) / 10 bar (gas)

| Ref. | Ø | €/Ud. |
|--------------|-----|----------|
| HDPE11000025 | 25 | 5,00 |
| HDPE11000032 | 32 | 5,95 |
| HDPE11000040 | 40 | 7,44 |
| HDPE11000050 | 50 | 8,48 |
| HDPE11000063 | 63 | 15,13 |
| HDPE11000075 | 75 | 20,43 |
| HDPE11000090 | 90 | 16,53 |
| HDPE11000110 | 110 | 23,49 |
| HDPE11000125 | 125 | 53,83 |
| HDPE11000140 | 140 | 60,12 |
| HDPE11000160 | 160 | 57,70 |
| HDPE11000180 | 180 | 89,42 |
| HDPE11000200 | 200 | 104,35 |
| HDPE11000225 | 225 | 145,13 |
| HDPE11000250 | 250 | 251,70 |
| HDPE11000280 | 280 | 379,71 |
| HDPE11000315 | 315 | 460,99 |
| HDPE11000355 | 355 | 1.052,49 |
| HDPE11000400 | 400 | 1.299,22 |
| HDPE11000450 | 450 | 1.772,06 |
| HDPE11000500 | 500 | 1.988,12 |

PE 100 SDR17 - Máxima presión de trabajo permitida 10 bar (agua) / 5 bar (gas)

| Ref. | Ø | €/Ud. |
|--------------|-----|----------|
| HDPE17000063 | 63 | 6,26 |
| HDPE17000075 | 75 | 18,47 |
| HDPE17000090 | 90 | 15,72 |
| HDPE17000110 | 110 | 22,28 |
| HDPE17000125 | 125 | 48,56 |
| HDPE17000140 | 140 | 59,59 |
| HDPE17000160 | 160 | 44,29 |
| HDPE17000180 | 180 | 79,79 |
| HDPE17000200 | 200 | 83,98 |
| HDPE17000225 | 225 | 130,57 |
| HDPE17000250 | 250 | 216,53 |
| HDPE17000280 | 280 | 326,75 |
| HDPE17000315 | 315 | 406,57 |
| HDPE17000355 | 355 | 758,22 |
| HDPE17000400 | 400 | 1.138,24 |
| HDPE17000450 | 450 | 1.340,29 |
| HDPE17000500 | 500 | 1.572,35 |



Aplicación



GDPE - CODO 90°

Con cuello largo para soldar con accesorios de alta seguridad FRIALEN, o soldadura a tope.

PE 100 SDR11 - Máxima presión de trabajo permitida 16 bar (agua) / 10 bar (gas)

| Ref. | Ø | €/Ud. |
|--------------|-----|----------|
| GDPE11000025 | 25 | 4,55 |
| GDPE11000032 | 32 | 4,97 |
| GDPE11000040 | 40 | 6,29 |
| GDPE11000050 | 50 | 8,31 |
| GDPE11000063 | 63 | 15,13 |
| GDPE11000075 | 75 | 19,96 |
| GDPE11000090 | 90 | 14,73 |
| GDPE11000110 | 110 | 23,13 |
| GDPE11000125 | 125 | 53,83 |
| GDPE11000140 | 140 | 60,12 |
| GDPE11000160 | 160 | 63,43 |
| GDPE11000180 | 180 | 88,63 |
| GDPE11000200 | 200 | 112,83 |
| GDPE11000225 | 225 | 154,48 |
| GDPE11000250 | 250 | 240,50 |
| GDPE11000280 | 280 | 405,08 |
| GDPE11000315 | 315 | 510,14 |
| GDPE11000355 | 355 | 1.030,63 |
| GDPE11000400 | 400 | 1.314,42 |
| GDPE11000450 | 450 | 1.719,67 |
| GDPE11000500 | 500 | 2.098,02 |

PE 100 SDR17 - Máxima presión de trabajo permitida 10 bar (agua) / 5 bar (gas)

| Ref. | Ø | €/Ud. |
|--------------|-----|----------|
| GDPE17000063 | 63 | 6,62 |
| GDPE17000075 | 75 | 18,07 |
| GDPE17000090 | 90 | 14,79 |
| GDPE17000110 | 110 | 24,90 |
| GDPE17000125 | 125 | 48,56 |
| GDPE17000140 | 140 | 59,59 |
| GDPE17000160 | 160 | 53,33 |
| GDPE17000180 | 180 | 79,79 |
| GDPE17000200 | 200 | 102,41 |
| GDPE17000225 | 225 | 130,57 |
| GDPE17000250 | 250 | 215,24 |
| GDPE17000280 | 280 | 324,84 |
| GDPE17000315 | 315 | 406,71 |
| GDPE17000355 | 355 | 841,52 |
| GDPE17000400 | 400 | 1.025,61 |
| GDPE17000450 | 450 | 1.304,76 |
| GDPE17000500 | 500 | 1.684,49 |

Para otras medidas, diámetros y tipo de accesorios, consultar.



Aplicación



YEPE - Y 45°

Con cuello largo para soldar con accesorios de alta seguridad FRIALEN, o soldadura a tope.

PE 100 SDR11 - Máxima presión de trabajo permitida 16 bar (agua) / 10 bar (gas)

| Ref. | Ø | €/Ud. |
|--------------|-----|--------|
| YEPE11000040 | 40 | 10,22 |
| YEPE11000050 | 50 | 17,65 |
| YEPE11000063 | 63 | 32,89 |
| YEPE11000075 | 75 | 43,98 |
| YEPE11000090 | 90 | 78,59 |
| YEPE11000110 | 110 | 105,61 |
| YEPE11000125 | 125 | 207,89 |
| YEPE11000160 | 160 | 335,93 |
| YEPE11000180 | 180 | 445,67 |
| YEPE11000200 | 200 | 550,97 |
| YEPE11000225 | 225 | 756,90 |
| YEPE17000315 | 315 | 894,34 |

PE 100 SDR17 - Máxima presión de trabajo permitida 10 bar (agua) / 5 bar (gas)

| Ref. | Ø | €/Ud. |
|--------------|-----|--------|
| YEPE17000040 | 40 | 5,33 |
| YEPE17000050 | 50 | 16,78 |
| YEPE17000063 | 63 | 28,26 |
| YEPE17000075 | 75 | 40,42 |
| YEPE17000090 | 90 | 84,96 |
| YEPE17000110 | 110 | 75,98 |
| YEPE17000125 | 125 | 190,15 |
| YEPE17000160 | 160 | 317,85 |
| YEPE17000180 | 180 | 418,05 |
| YEPE17000200 | 200 | 494,70 |
| YEPE17000225 | 225 | 713,00 |
| YEPE17000315 | 315 | 730,52 |



Aplicación



TEPE - TE IGUAL 90°

Con cuello largo para soldar con accesorios de alta seguridad FRIALEN, o soldadura a tope.

PE 100 SDR11 - Máxima presión de trabajo permitida 16 bar (agua) / 10 bar (gas)

| Ref. | Ø | €/Ud. |
|--------------|-----|----------|
| TEPE11000025 | 25 | 5,53 |
| TEPE11000032 | 32 | 6,60 |
| TEPE11000040 | 40 | 7,94 |
| TEPE11000050 | 50 | 10,50 |
| TEPE11000063 | 63 | 14,43 |
| TEPE11000075 | 75 | 21,81 |
| TEPE11000090 | 90 | 20,46 |
| TEPE11000110 | 110 | 31,83 |
| TEPE11000125 | 125 | 67,36 |
| TEPE11000140 | 140 | 101,83 |
| TEPE11000160 | 160 | 80,80 |
| TEPE11000180 | 180 | 167,11 |
| TEPE11000200 | 200 | 153,72 |
| TEPE11000225 | 225 | 284,99 |
| TEPE11000250 | 250 | 404,58 |
| TEPE11000280 | 280 | 520,27 |
| TEPE11000315 | 315 | 777,16 |
| TEPE11000355 | 355 | 1.262,52 |
| TEPE11000400 | 400 | 1.328,50 |
| TEPE11000450 | 450 | 1.599,61 |
| TEPE11000500 | 500 | 2.007,72 |

PE 100 SDR17 - Máxima presión de trabajo permitida 10 bar (agua) / 5 bar (gas)

| Ref. | Ø | €/Ud. |
|--------------|-----|----------|
| TEPE17000063 | 63 | 11,11 |
| TEPE17000075 | 75 | 18,89 |
| TEPE17000090 | 90 | 22,87 |
| TEPE17000110 | 110 | 30,42 |
| TEPE17000125 | 125 | 57,23 |
| TEPE17000140 | 140 | 87,01 |
| TEPE17000160 | 160 | 73,31 |
| TEPE17000180 | 180 | 142,19 |
| TEPE17000200 | 200 | 131,21 |
| TEPE17000225 | 225 | 241,96 |
| TEPE17000250 | 250 | 242,94 |
| TEPE17000280 | 280 | 332,53 |
| TEPE17000315 | 315 | 462,56 |
| TEPE17000355 | 355 | 1.179,92 |
| TEPE17000400 | 400 | 1.054,18 |
| TEPE17000450 | 450 | 1.232,43 |
| TEPE17000500 | 500 | 1.864,71 |

Para otras medidas, diámetros y tipo de accesorios, consultar.



Aplicación

**TRPE - TE REDUCIDA 90°**

Con cuello largo para soldar con accesorios de alta seguridad FRIALEN, o soldadura a tope.

PE 100 SDR11 - Máxima presión de trabajo permitida 16 bar (agua) / 10 bar (gas)

| Ref. | Ø | €/Ud. |
|--------------|---------|--------|
| TRPE11006332 | 63-32 | 29,53 |
| TRPE11011063 | 110-63 | 51,59 |
| TRPE11011090 | 110-90 | 33,60 |
| TRPE11012563 | 125-63 | 77,86 |
| TRPE11012575 | 125-75 | 77,86 |
| TRPE11012590 | 125-90 | 77,86 |
| TRPE11125110 | 125-110 | 77,86 |
| TRPE11014063 | 140-63 | 117,57 |
| TRPE11014075 | 140-75 | 102,08 |
| TRPE11014090 | 140-90 | 117,57 |
| TRPE11140110 | 140-110 | 121,81 |
| TRPE11016063 | 160-63 | 140,95 |
| TRPE11016075 | 160-75 | 123,30 |
| TRPE11016090 | 160-90 | 142,04 |
| TRPE11160110 | 160-110 | 145,72 |
| TRPE11018075 | 180-75 | 201,91 |
| TRPE11018090 | 180-90 | 201,91 |
| TRPE11180110 | 180-110 | 201,91 |
| TRPE11180125 | 180-125 | 201,91 |

| Ref. | Ø | €/Ud. |
|--------------|---------|--------|
| TRPE11180140 | 180-140 | 196,04 |
| TRPE11180160 | 180-160 | 196,04 |
| TRPE11020063 | 200-63 | 256,14 |
| TRPE11020075 | 200-75 | 256,14 |
| TRPE11020090 | 200-90 | 256,14 |
| TRPE11200110 | 200-110 | 181,37 |
| TRPE11200125 | 200-125 | 256,14 |
| TRPE11200160 | 200-160 | 256,14 |
| TRPE11022563 | 225-63 | 316,51 |
| TRPE11022575 | 225-75 | 316,51 |
| TRPE11022590 | 225-90 | 328,91 |
| TRPE11225110 | 225-110 | 331,35 |
| TRPE11225125 | 225-125 | 332,25 |
| TRPE11225140 | 225-140 | 332,45 |
| TRPE11225160 | 225-160 | 332,45 |
| TRPE11250160 | 250-160 | 436,94 |
| TRPE11280160 | 280-160 | 373,54 |
| TRPE11315160 | 315-160 | 508,23 |

PE 100 SDR17 - Máxima presión de trabajo permitida 10 bar (agua) / 5 bar (gas)

| Ref. | Ø | €/Ud. |
|--------------|---------|--------|
| TRPE17011063 | 110-63 | 46,28 |
| TRPE17011090 | 110-90 | 35,56 |
| TRPE17012563 | 125-63 | 61,02 |
| TRPE17012575 | 125-75 | 61,02 |
| TRPE17012590 | 125-90 | 61,02 |
| TRPE17125110 | 125-110 | 61,02 |
| TRPE17014063 | 140-63 | 100,70 |
| TRPE17014075 | 140-75 | 100,70 |
| TRPE17014090 | 140-90 | 100,70 |
| TRPE17140110 | 140-110 | 104,66 |
| TRPE17016063 | 160-63 | 126,86 |
| TRPE17016075 | 160-75 | 130,76 |
| TRPE17016090 | 160-90 | 130,76 |
| TRPE17160110 | 160-110 | 131,88 |
| TRPE17018075 | 180-75 | 201,91 |
| TRPE17018090 | 180-90 | 201,91 |
| TRPE17180110 | 180-110 | 201,91 |

| Ref. | Ø | €/Ud. |
|--------------|---------|--------|
| TRPE17180125 | 180-125 | 201,91 |
| TRPE17180140 | 180-140 | 176,29 |
| TRPE17180160 | 180-160 | 176,29 |
| TRPE17020063 | 200-63 | 225,91 |
| TRPE17020075 | 200-75 | 225,91 |
| TRPE17020090 | 200-90 | 225,91 |
| TRPE17200110 | 200-110 | 144,82 |
| TRPE17200125 | 200-125 | 225,91 |
| TRPE17200160 | 200-160 | 225,91 |
| TRPE17022563 | 225-63 | 296,38 |
| TRPE17022575 | 225-75 | 296,38 |
| TRPE17022590 | 225-90 | 296,38 |
| TRPE17225110 | 225-110 | 298,49 |
| TRPE17225125 | 225-125 | 298,49 |
| TRPE17225140 | 225-140 | 298,49 |
| TRPE17225160 | 225-160 | 298,49 |

Para otras medidas, diámetros y tipo de accesorios, consultar.



Aplicación

**CDPE - TAPÓN**

Con cuello largo para soldar con accesorios de alta seguridad FRIALEN, o soldadura a tope.

PE 100 SDR11 - Máxima presión de trabajo permitida 16 bar (agua) / 10 bar (gas)

| Ref. | Ø | €/Ud. |
|--------------|-----|----------|
| CDPE11000025 | 25 | 4,10 |
| CDPE11000032 | 32 | 4,77 |
| CDPE11000040 | 40 | 6,37 |
| CDPE11000050 | 50 | 8,14 |
| CDPE11000063 | 63 | 10,75 |
| CDPE11000075 | 75 | 19,93 |
| CDPE11000090 | 90 | 11,20 |
| CDPE11000110 | 110 | 17,49 |
| CDPE11000125 | 125 | 35,42 |
| CDPE11000140 | 140 | 44,63 |
| CDPE11000160 | 160 | 34,91 |
| CDPE11000180 | 180 | 64,22 |
| CDPE11000200 | 200 | 63,94 |
| CDPE11000225 | 225 | 95,48 |
| CDPE11000250 | 250 | 110,02 |
| CDPE11000280 | 280 | 155,01 |
| CDPE11000315 | 315 | 212,27 |
| CDPE11000355 | 355 | 419,17 |
| CDPE11000400 | 400 | 529,50 |
| CDPE11000450 | 450 | 414,63 |
| CDPE11000500 | 500 | 546,51 |
| CDPE11000630 | 630 | 1.193,95 |

PE 100 SDR17 - Máxima presión de trabajo permitida 10 bar (agua) / 5 bar (gas)

| Ref. | Ø | €/Ud. |
|--------------|-----|--------|
| CDPE17000063 | 63 | 2,53 |
| CDPE17000075 | 75 | 20,10 |
| CDPE17000090 | 90 | 10,36 |
| CDPE17000110 | 110 | 13,64 |
| CDPE17000125 | 125 | 35,34 |
| CDPE17000140 | 140 | 44,29 |
| CDPE17000160 | 160 | 28,96 |
| CDPE17000180 | 180 | 64,22 |
| CDPE17000200 | 200 | 58,24 |
| CDPE17000225 | 225 | 95,48 |
| CDPE17000250 | 250 | 56,69 |
| CDPE17000280 | 280 | 155,01 |
| CDPE17000315 | 315 | 212,27 |
| CDPE17000355 | 355 | 332,81 |
| CDPE17000400 | 400 | 408,00 |
| CDPE17000450 | 450 | 276,37 |
| CDPE17000500 | 500 | 361,08 |
| CDPE17000630 | 630 | 733,60 |



Aplicación



CUPE - CURVA 11°

Con cuello largo para soldar con accesorios de alta seguridad FRIALEN, o soldadura a tope.

PE 100 SDR11 - Máxima presión de trabajo permitida 16 bar (agua) / 10 bar (gas)

| Ref. | Ø | €/Ud. |
|--------------|-----|----------|
| CU11PE110090 | 90 | 84,09 |
| CU11PE110110 | 110 | 111,99 |
| CU11PE110125 | 125 | 124,39 |
| CU11PE110140 | 140 | 140,30 |
| CU11PE110160 | 160 | 160,23 |
| CU11PE110180 | 180 | 267,81 |
| CU11PE110200 | 200 | 324,45 |
| CU11PE110225 | 225 | 387,32 |
| CU11PE110250 | 250 | 464,28 |
| CU11PE110280 | 280 | 567,87 |
| CU11PE110315 | 315 | 689,15 |
| CU11PE110355 | 355 | 1.272,51 |
| CU11PE110400 | 400 | 1.413,88 |
| CU11PE110450 | 450 | 1.737,21 |

PE 100 SDR17 - Máxima presión de trabajo permitida 10 bar (agua) / 5 bar (gas)

| Ref. | Ø | €/Ud. |
|--------------|-----|----------|
| CU11PE170090 | 90 | 69,04 |
| CU11PE170110 | 110 | 88,52 |
| CU11PE170125 | 125 | 100,51 |
| CU11PE170140 | 140 | 114,65 |
| CU11PE170160 | 160 | 123,04 |
| CU11PE170180 | 180 | 196,52 |
| CU11PE170200 | 200 | 237,70 |
| CU11PE170225 | 225 | 251,03 |
| CU11PE170250 | 250 | 349,65 |
| CU11PE170280 | 280 | 398,83 |
| CU11PE170315 | 315 | 514,29 |
| CU11PE170355 | 355 | 820,16 |
| CU11PE170400 | 400 | 1.241,94 |
| CU11PE170450 | 450 | 1.382,33 |



Aplicación



CUPE - CURVA 22°

Con cuello largo para soldar con accesorios de alta seguridad FRIALEN, o soldadura a tope.

PE 100 SDR11 - Máxima presión de trabajo permitida 16 bar (agua) / 10 bar (gas)

| Ref. | Ø | €/Ud. |
|--------------|-----|----------|
| CU22PE110090 | 90 | 84,09 |
| CU22PE110110 | 110 | 111,99 |
| CU22PE110125 | 125 | 124,39 |
| CU22PE110140 | 140 | 140,30 |
| CU22PE110160 | 160 | 160,23 |
| CU22PE110180 | 180 | 267,81 |
| CU22PE110200 | 200 | 324,45 |
| CU22PE110225 | 225 | 387,32 |
| CU22PE110250 | 250 | 464,28 |
| CU22PE110280 | 280 | 567,87 |
| CU22PE110315 | 315 | 689,15 |
| CU22PE110355 | 355 | 1.272,51 |
| CU22PE110400 | 400 | 1.413,88 |
| CU22PE110450 | 450 | 1.737,21 |

PE 100 SDR17 - Máxima presión de trabajo permitida 10 bar (agua) / 5 bar (gas)

| Ref. | Ø | €/Ud. |
|--------------|-----|----------|
| CU22PE170090 | 90 | 69,04 |
| CU22PE170110 | 110 | 88,52 |
| CU22PE170125 | 125 | 100,51 |
| CU22PE170140 | 140 | 102,08 |
| CU22PE170160 | 160 | 123,04 |
| CU22PE170180 | 180 | 196,52 |
| CU22PE170200 | 200 | 211,62 |
| CU22PE170225 | 225 | 281,96 |
| CU22PE170250 | 250 | 349,65 |
| CU22PE170280 | 280 | 355,07 |
| CU22PE170315 | 315 | 514,29 |
| CU22PE170355 | 355 | 820,16 |
| CU22PE170400 | 400 | 1.241,94 |
| CU22PE170450 | 450 | 1.382,33 |



Aplicación



CUPE - CURVA 30°

Con cuello largo para soldar con accesorios de alta seguridad FRIALEN, o soldadura a tope.

PE 100 SDR11 - Máxima presión de trabajo permitida 16 bar (agua) / 10 bar (gas)

| Ref. | Ø | €/Ud. |
|--------------|-----|----------|
| CU30PE110090 | 90 | 84,09 |
| CU30PE110110 | 110 | 111,99 |
| CU30PE110125 | 125 | 110,75 |
| CU30PE110140 | 140 | 140,30 |
| CU30PE110160 | 160 | 142,63 |
| CU30PE110180 | 180 | 267,81 |
| CU30PE110200 | 200 | 288,86 |
| CU30PE110225 | 225 | 344,83 |
| CU30PE110250 | 250 | 413,36 |
| CU30PE110280 | 280 | 567,87 |
| CU30PE110315 | 315 | 613,56 |
| CU30PE110355 | 355 | 1.132,93 |
| CU30PE110400 | 400 | 1.413,88 |
| CU30PE110450 | 450 | 1.737,21 |

PE 100 SDR17 - Máxima presión de trabajo permitida 10 bar (agua) / 5 bar (gas)

| Ref. | Ø | €/Ud. |
|--------------|-----|----------|
| CU30PE170090 | 90 | 69,04 |
| CU30PE170110 | 110 | 88,52 |
| CU30PE170125 | 125 | 100,51 |
| CU30PE170140 | 140 | 114,65 |
| CU30PE170160 | 160 | 123,04 |
| CU30PE170180 | 180 | 196,52 |
| CU30PE170200 | 200 | 211,62 |
| CU30PE170225 | 225 | 281,96 |
| CU30PE170250 | 250 | 349,65 |
| CU30PE170280 | 280 | 355,07 |
| CU30PE170315 | 315 | 514,29 |
| CU30PE170355 | 355 | 820,16 |
| CU30PE170400 | 400 | 1.241,94 |
| CU30PE170450 | 450 | 1.382,33 |



Aplicación



CUPE - CURVA 45°

Con cuello largo para soldar con accesorios de alta seguridad FRIALEN, o soldadura a tope.

PE 100 SDR11 - Máxima presión de trabajo permitida 16 bar (agua) / 10 bar (gas)

| Ref. | Ø | €/Ud. |
|--------------|-----|----------|
| CU45PE110090 | 90 | 84,09 |
| CU45PE110110 | 110 | 111,99 |
| CU45PE110125 | 125 | 124,39 |
| CU45PE110140 | 140 | 140,30 |
| CU45PE110160 | 160 | 160,23 |
| CU45PE110180 | 180 | 267,81 |
| CU45PE110200 | 200 | 288,86 |
| CU45PE110225 | 225 | 387,32 |
| CU45PE110250 | 250 | 464,28 |
| CU45PE110280 | 280 | 567,87 |
| CU45PE110315 | 315 | 689,15 |
| CU45PE110355 | 355 | 1.272,51 |
| CU45PE110400 | 400 | 1.413,88 |
| CU45PE110450 | 450 | 1.737,21 |

PE 100 SDR17 - Máxima presión de trabajo permitida 10 bar (agua) / 5 bar (gas)

| Ref. | Ø | €/Ud. |
|--------------|-----|----------|
| CU45PE170090 | 90 | 69,04 |
| CU45PE170110 | 110 | 88,52 |
| CU45PE170125 | 125 | 100,51 |
| CU45PE170140 | 140 | 114,65 |
| CU45PE170160 | 160 | 123,04 |
| CU45PE170180 | 180 | 174,97 |
| CU45PE170200 | 200 | 237,70 |
| CU45PE170225 | 225 | 281,96 |
| CU45PE170250 | 250 | 349,65 |
| CU45PE170280 | 280 | 398,83 |
| CU45PE170315 | 315 | 514,29 |
| CU45PE170355 | 355 | 820,16 |
| CU45PE170400 | 400 | 1.241,94 |
| CU45PE170450 | 450 | 1.382,33 |



Aplicación



CUPE - CURVA 60°

Con cuello largo para soldar con accesorios de alta seguridad FRIALEN, o soldadura a tope.

PE 100 SDR11 - Máxima presión de trabajo permitida 16 bar (agua) / 10 bar (gas)

| Ref. | Ø | €/Ud. |
|--------------|-----|----------|
| CU60PE110090 | 90 | 74,88 |
| CU60PE110110 | 110 | 99,72 |
| CU60PE110125 | 125 | 110,75 |
| CU60PE110140 | 140 | 124,92 |
| CU60PE110160 | 160 | 160,23 |
| CU60PE110180 | 180 | 267,81 |
| CU60PE110200 | 200 | 324,45 |
| CU60PE110225 | 225 | 344,83 |
| CU60PE110250 | 250 | 413,36 |
| CU60PE110280 | 280 | 505,59 |
| CU60PE110315 | 315 | 613,56 |
| CU60PE110355 | 355 | 1.132,93 |
| CU60PE110400 | 400 | 1.258,78 |
| CU60PE110450 | 450 | 1.546,67 |

PE 100 SDR17 - Máxima presión de trabajo permitida 10 bar (agua) / 5 bar (gas)

| Ref. | Ø | €/Ud. |
|--------------|-----|----------|
| CU60PE170090 | 90 | 61,47 |
| CU60PE170110 | 110 | 78,81 |
| CU60PE170125 | 125 | 89,48 |
| CU60PE170140 | 140 | 102,08 |
| CU60PE170160 | 160 | 109,54 |
| CU60PE170180 | 180 | 174,97 |
| CU60PE170200 | 200 | 211,62 |
| CU60PE170225 | 225 | 251,03 |
| CU60PE170250 | 250 | 311,31 |
| CU60PE170280 | 280 | 355,07 |
| CU60PE170315 | 315 | 457,88 |
| CU60PE170355 | 355 | 730,21 |
| CU60PE170400 | 400 | 1.105,71 |
| CU60PE170450 | 450 | 1.329,15 |



Aplicación



CUPE - CURVA 90°

Con cuello largo para soldar con accesorios de alta seguridad FRIALEN, o soldadura a tope.

PE 100 SDR11 - Máxima presión de trabajo permitida 16 bar (agua) / 10 bar (gas)

| Ref. | Ø | €/Ud. |
|--------------|-----|----------|
| CU90PE110090 | 90 | 87,17 |
| CU90PE110110 | 110 | 116,42 |
| CU90PE110125 | 125 | 133,65 |
| CU90PE110140 | 140 | 153,58 |
| CU90PE110160 | 160 | 178,81 |
| CU90PE110180 | 180 | 295,23 |
| CU90PE110200 | 200 | 358,49 |
| CU90PE110225 | 225 | 425,35 |
| CU90PE110250 | 250 | 529,33 |
| CU90PE110280 | 280 | 663,04 |
| CU90PE110315 | 315 | 822,83 |
| CU90PE110355 | 355 | 1.230,91 |
| CU90PE110400 | 400 | 1.385,16 |
| CU90PE110450 | 450 | 1.957,72 |

PE 100 SDR17 - Máxima presión de trabajo permitida 10 bar (agua) / 5 bar (gas)

| Ref. | Ø | €/Ud. |
|--------------|-----|----------|
| CU90PE170090 | 90 | 71,29 |
| CU90PE170110 | 110 | 91,67 |
| CU90PE170125 | 125 | 106,26 |
| CU90PE170140 | 140 | 122,62 |
| CU90PE170160 | 160 | 134,52 |
| CU90PE170180 | 180 | 215,10 |
| CU90PE170200 | 200 | 258,94 |
| CU90PE170225 | 225 | 304,97 |
| CU90PE170250 | 250 | 395,68 |
| CU90PE170280 | 280 | 459,45 |
| CU90PE170315 | 315 | 599,75 |
| CU90PE170355 | 355 | 728,21 |
| CU90PE170400 | 400 | 1.219,38 |
| CU90PE170450 | 450 | 1.597,87 |



**PORTABRIDAS INYECTADO
CUELLO LARGO SDR 11**

Máxima presión de trabajo permitida
16 bar (agua) / 10 bar (gas)

| Ref. | Ø | €/Ud |
|---------|-----|-----------|
| 4013025 | 25 | 2,19 |
| 4013032 | 32 | 3,40 |
| 4013040 | 40 | 3,65 |
| 4013050 | 50 | 3,65 |
| 4013063 | 63 | 4,55 |
| 4013075 | 75 | 6,74 |
| 4013090 | 90 | 8,62 |
| 4013110 | 110 | 11,70 |
| 4013125 | 125 | 14,31 |
| 4013140 | 140 | 18,83 |
| 4013160 | 160 | 22,00 |
| 4013180 | 180 | 25,74 |
| 4013200 | 200 | 38,93 |
| 4013225 | 225 | 40,11 |
| 4013250 | 250 | 73,96 |
| 4013280 | 280 | 93,57 |
| 4013315 | 315 | 110,89 |
| 4013355 | 355 | 189,48 |
| 4013400 | 400 | 308,73 |
| 4013450 | 450 | 411,79 |
| 4013500 | 500 | 350,83 |
| 4013560 | 560 | Consultar |
| 4013630 | 630 | Consultar |

**PORTABRIDAS INYECTADO
CUELLO LARGO SDR 17**

Máxima presión de trabajo permitida
10 bar (agua) / 5 bar (gas)

| Ref. | Ø | €/Ud |
|------------|-----|--------|
| 4013050010 | 50 | 10,75 |
| 4013063010 | 63 | 6,43 |
| 4013075010 | 75 | 7,55 |
| 4013090010 | 90 | 7,10 |
| 4013110010 | 110 | 9,63 |
| 4013125010 | 125 | 10,38 |
| 4013140010 | 140 | 15,32 |
| 4013160010 | 160 | 19,81 |
| 4013180010 | 180 | 20,74 |
| 4013200010 | 200 | 28,38 |
| 4013225010 | 225 | 36,96 |
| 4013250010 | 250 | 66,69 |
| 4013280010 | 280 | 80,80 |
| 4013315010 | 315 | 99,69 |
| 4013355010 | 355 | 157,09 |
| 4013400010 | 400 | 297,84 |
| 4013450010 | 450 | 358,52 |
| 4013500010 | 500 | 291,13 |
| 4013560010 | 560 | 506,97 |
| 4013630010 | 630 | 650,05 |



PORTABRIDAS MANIPULADO SDR 11

Máxima presión de trabajo permitida 16 bar (agua)

| Ref. | Ø | €/Ud |
|--------------|-----|----------|
| 136280000160 | 280 | 180,76 |
| 136315000160 | 315 | 230,92 |
| 136355000160 | 355 | 366,55 |
| 136400000160 | 400 | 462,16 |
| 136450000160 | 450 | 771,91 |
| 136500000160 | 500 | 723,31 |
| 136560000160 | 560 | 1.053,76 |
| 136630000160 | 630 | 1.019,32 |

PORTABRIDAS MANIPULADO SDR 17

Máxima presión de trabajo permitida 10 bar (agua)

| Ref. | Ø | €/Ud |
|--------------|------|----------|
| 136280000100 | 280 | 128,75 |
| 136315000100 | 315 | 163,79 |
| 136355000100 | 355 | 267,31 |
| 136400000100 | 400 | 345,28 |
| 136450000100 | 450 | 577,68 |
| 136500000100 | 500 | 556,57 |
| 136560000100 | 560 | 924,73 |
| 136630000100 | 630 | 762,57 |
| 136710000100 | 710 | 1.152,34 |
| 136800000100 | 800 | 1.473,34 |
| 136900000100 | 900 | 1.784,86 |
| 136100000100 | 1000 | 5.206,61 |



BRIDAS DE ACERO CINCADO
PN10 (DIN 2576) MOP 10 BAR

| Ref. | PN | Ø Tubo | DN | Nº Agujeros | €/Ud |
|---------------|-------|---------|------|-------------|-----------|
| 311050016055 | 10/16 | 50 | 40 | 4 | 12,27 |
| 311063016055 | 10/16 | 63 | 50 | 4 | 14,29 |
| 311075016055 | 10/16 | 75 | 65 | 4 | 17,48 |
| 311090016055 | 10/16 | 90 | 80 | 8 | 22,04 |
| 311110016055 | 10/16 | 110 | 100 | 8 | 24,31 |
| 311125016055 | 10/16 | 125 | 125 | 8 | 32,68 |
| 311140016055 | 10/16 | 140 | 125 | 8 | 27,44 |
| 311160016055 | 10/16 | 160 | 150 | 8 | 41,26 |
| 311180016055* | 10/16 | 180 | 150 | 8 | 51,50 |
| 311200010055 | 10 | 200 | 200 | 8 | 56,89 |
| 311225010055* | 10 | 225 | 200 | 8 | 73,83 |
| 311250010055 | 10 | 250 | 250 | 12 | 59,36 |
| 311280010055* | 10 | 280 | 250 | 12 | 92,44 |
| 311315010055 | 10 | 315 | 300 | 12 | 76,45 |
| 311355010055 | 10 | 355 | 350 | 16 | 103,88 |
| 311400010055 | 10 | 400 | 400 | 16 | 145,28 |
| 311450010055* | 10 | 450 | 450 | 20 | Consultar |
| 311500010155* | 10 | 450-500 | 500 | 20 | 320,87 |
| 311500010055 | 10 | 500 | 500 | 20 | 207,76 |
| 311560010055* | 10 | 560 | 600 | 20 | 402,35 |
| 311630010055 | 10 | 630 | 600 | 20 | 271,26 |
| 311710010055* | 10 | 710 | 700 | 24 | 523,37 |
| 311800010055* | 10 | 800 | 800 | 24 | 697,38 |
| 311900010055* | 10 | 900 | 900 | 28 | 836,04 |
| 311100010055* | 10 | 1000 | 1000 | 28 | 1.066,88 |

* Galvanizadas

BRIDAS DE ACERO CINCADO
PN16 (DIN 2502) MOP 16 BAR

| Ref. | PN | Ø Tubo | DN | Nº Agujeros | €/Ud |
|---------------|----|---------|------|-------------|-----------|
| 311200016055 | 16 | 200 | 200 | 12 | 55,93 |
| 311225016055* | 16 | 225 | 200 | 12 | 71,12 |
| 311250016055 | 16 | 250 | 250 | 12 | 74,42 |
| 311280016055* | 16 | 280 | 250 | 12 | 100,69 |
| 311315016055 | 16 | 315 | 300 | 12 | 97,06 |
| 311355016055 | 16 | 355 | 350 | 16 | 140,32 |
| 311400016055 | 16 | 400 | 400 | 16 | 176,29 |
| 311450016055* | 16 | 450 | 450 | 20 | Consultar |
| 311500016155* | 16 | 450-500 | 500 | 20 | 434,85 |
| 311500016055 | 16 | 500 | 500 | 20 | 349,59 |
| 311560016055* | 16 | 560 | 600 | 20 | 683,87 |
| 311630016055 | 16 | 630 | 600 | 20 | 472,92 |
| 311710016055* | 16 | 710 | 700 | 24 | 680,81 |
| 311800016055* | 16 | 800 | 800 | 24 | 863,77 |
| 311900016055* | 16 | 900 | 900 | 28 | 1.026,41 |
| 311100016055* | 16 | 1000 | 1000 | 28 | 1.368,80 |

* Galvanizadas

**BRIDAS CIEGAS DE ACERO CINCADO
PN10 (DIN 2527) MOP 10/16 Y 10 BAR**

| Ref. | DN Brida | PN | Nº Agujeros | €/Ud |
|--------------|-----------|-------|-------------|--------|
| 312015010055 | 1/2" 15 | 10/16 | 4 | 5,52 |
| 312020010055 | 3/4" 20 | 10/16 | 4 | 7,78 |
| 312025010055 | 1" 25 | 10/16 | 4 | 9,43 |
| 312032010055 | 1 1/4" 32 | 10/16 | 4 | 12,30 |
| 312040010055 | 1 1/2" 40 | 10/16 | 4 | 14,27 |
| 312050010055 | 2" 50 | 10/16 | 4 | 19,64 |
| 312065010055 | 2 1/2" 65 | 10/16 | 4 | 24,38 |
| 312080010055 | 3" 80 | 10/16 | 4 | 31,78 |
| 312100010055 | 4" 100 | 10/16 | 8 | 37,63 |
| 312125010055 | 5" 125 | 10/16 | 8 | 56,51 |
| 312150010055 | 6" 150 | 10/16 | 8 | 69,29 |
| 312200010055 | 8" 200 | 10 | 8 | 109,85 |
| 312250010055 | 10" 250 | 10 | 12 | 159,85 |
| 312300010055 | 12" 300 | 10 | 12 | 205,71 |
| 312350010055 | 14" 350 | 10 | 16 | 268,44 |
| 312400010055 | 16" 400 | 10 | 16 | 329,41 |
| 312450010055 | 18" 450 | 10 | 20 | 419,22 |
| 312500010055 | 20" 500 | 10 | 20 | 499,35 |
| 312600010055 | 24" 600 | 10 | 20 | 729,24 |

**BRIDAS CIEGAS DE ACERO CINCADO
PN16 (DIN 2527) MOP 16 BAR**

| Ref. | DN Brida | PN | Nº Agujeros | €/Ud |
|--------------|----------|----|-------------|--------|
| 312200016055 | 8" 200 | 16 | 12 | 106,16 |
| 312250016055 | 10" 250 | 16 | 12 | 163,87 |
| 312300016055 | 12" 300 | 16 | 12 | 230,42 |
| 312350016055 | 14" 350 | 16 | 16 | 313,24 |
| 312400016055 | 16" 400 | 16 | 16 | 416,49 |
| 312450016055 | 18" 450 | 16 | 20 | 570,46 |
| 312500016055 | 20" 500 | 16 | 20 | 668,90 |
| 312600016055 | 24" 600 | 16 | 20 | 934,54 |

ODB



| d | Ref. | DN | PN | € |
|-----|-------------|------|----|----------|
| 20 | ODB020 | 15 | 16 | 8,85 |
| 25 | ODB025 | 20 | 16 | 9,72 |
| 32 | ODB032 | 25 | 16 | 12,51 |
| 40 | ODB040 | 32 | 16 | 15,18 |
| 50 | ODB050 | 40 | 16 | 17,75 |
| 63 | ODB063 | 50 | 16 | 22,08 |
| 75 | ODB075 | 65 | 16 | 24,40 |
| 90 | ODB090 | 80 | 16 | 29,06 |
| 110 | ODB110 | 100 | 16 | 35,07 |
| 125 | ODB125 | 100 | 16 | 35,07 |
| 140 | ODB140 | 125 | 16 | 52,43 |
| 140 | ODB140DN125 | *125 | 16 | 50,37 |
| 160 | ODB160 | 150 | 16 | 53,41 |
| 180 | ODB180 | 150 | 16 | 61,24 |
| 200 | ODB200PN16 | 200 | 16 | 80,21 |
| 225 | ODB225PN16 | 200 | 16 | 80,21 |
| 250 | ODB250PN16 | 250 | 16 | 100,41 |
| 280 | ODB280PN16 | 250 | 16 | 102,29 |
| 315 | ODB315PN16 | 300 | 16 | 156,19 |
| 355 | ODB355PN16 | 350 | 16 | 292,39 |
| 400 | ODB400PN16 | 400 | 16 | 421,93 |
| 450 | ODB150PN16 | 450 | 16 | 754,43 |
| 500 | ODB500PN16 | 500 | 16 | 754,43 |
| 560 | ODB560PN16 | 600 | 16 | 1.023,11 |
| 630 | ODB630PN16 | 600 | 16 | 1.037,63 |

Brida loca PP con alma de acero

DIN 2501 DIN 16962/16963.

* Para portabridas PVC-U

Ver descuentos aplicables según "Familia PP"

A partir de Ø 75 no utilizar

con portabridas socket

(sólo testa)

ODB



| d | Ref. | DN | PN | € |
|-----|-------------|------|----|----------|
| 200 | ODB200 | 200 | 10 | 80,21 |
| 225 | ODB225 | 200 | 10 | 80,21 |
| 225 | ODB225DN200 | *200 | 10 | 103,49 |
| 250 | ODB250 | 250 | 10 | 100,41 |
| 280 | ODB280 | 250 | 10 | 102,29 |
| 280 | ODB280DN250 | *250 | 10 | 107,16 |
| 315 | ODB315 | 300 | 10 | 156,19 |
| 315 | ODB315DN300 | *300 | 10 | 156,94 |
| 355 | ODB355 | 350 | 10 | 292,39 |
| 400 | ODB400 | 400 | 10 | 421,93 |
| 450 | ODB450 | 450 | 10 | 754,43 |
| 500 | ODB500 | 500 | 10 | 754,43 |
| 560 | ODB560 | 600 | 10 | 1.023,11 |
| 630 | ODB630 | 600 | 10 | 1.037,63 |

Brida loca PP con alma de acero

DIN 2501 DIN 16962/16963.

* Para portabridas PVC-U

Ver descuentos aplicables según "Familia PP"

A partir de Ø 75 no utilizar

con portabridas socket

(sólo testa)

OAB



| d | Ref. | DN | € |
|--------|--------|-----|--------|
| 1/2" | OAB012 | 15 | 10,99 |
| 3/4" | OAB034 | 20 | 13,68 |
| 1" | OAB100 | 25 | 16,14 |
| 1 1/4" | OAB114 | 32 | 18,59 |
| 1 1/2" | OAB112 | 40 | 23,19 |
| 2" | OAB200 | 50 | 28,81 |
| 2 1/2" | OAB212 | 65 | 35,60 |
| 3" | OAB300 | 80 | 41,73 |
| 4" | OAB400 | 100 | 54,44 |
| 6" | OAB600 | 150 | 102,85 |
| 8" | OAB800 | 200 | 148,79 |
| 10" | OAB810 | 250 | 191,63 |
| 12" | OAB812 | 300 | 295,58 |
| 14" | OAB814 | 350 | 557,70 |
| 16" | OAB816 | 400 | 680,04 |

Brida loca PP con alma de acero

ANSI 150 lbs.

Ver descuentos aplicables según "Familia PP"

A partir de Ø 75 no utilizar

con portabridas socket

(sólo testa)

ODBC



| d | Ref. | DN | PN | € |
|---------|---------|-----|----|----------|
| 20 | ODBC020 | 15 | 16 | 67,53 |
| 25 | ODBC025 | 20 | 16 | 68,59 |
| 32 | ODBC032 | 25 | 16 | 70,33 |
| 40 | ODBC040 | 32 | 16 | 75,32 |
| 50 | ODBC050 | 40 | 16 | 85,30 |
| 63 | ODBC063 | 50 | 16 | 92,89 |
| 75 | ODBC075 | 65 | 16 | 108,81 |
| 90 | ODBC090 | 80 | 16 | 119,75 |
| 110/125 | ODBC110 | 100 | 16 | 163,58 |
| 140 | ODBC140 | 125 | 16 | 200,88 |
| 160/180 | ODBC160 | 150 | 16 | 253,51 |
| 200/225 | ODBC200 | 200 | 10 | 281,56 |
| 250/280 | ODBC250 | 250 | 10 | 367,93 |
| 315 | ODBC315 | 300 | 10 | 537,13 |
| 355 | ODBC355 | 350 | 10 | 1.050,68 |
| 400 | ODBC400 | 400 | 10 | 1.200,24 |

Brida ciega PP con alma de acero DIN 2501

Ver descuentos aplicables según "Familia PP"

OABC



| d | Ref. | DN | € |
|--------|---------|-----|--------|
| 1/2" | OABC012 | 15 | 78,52 |
| 3/4" | OABC034 | 20 | 79,63 |
| 1" | OABC100 | 25 | 81,59 |
| 1 1/4" | OABC114 | 32 | 87,42 |
| 1 1/2" | OABC112 | 40 | 99,25 |
| 2" | OABC200 | 50 | 108,02 |
| 2 1/2" | OABC212 | 65 | 123,41 |
| 3" | OABC300 | 80 | 139,15 |
| 4" | OABC400 | 100 | 190,13 |
| 6" | OABC600 | 150 | 294,77 |
| 8" | OABC800 | 200 | 327,32 |
| 10" | OABC810 | 250 | 427,45 |
| 12" | OABC812 | 300 | 624,68 |

Brida ciega PP con alma de acero ANSI 150 lbs.

Ver descuentos aplicables según "Familia PP"

Accesorios de PE



Accesorios de Polietileno inyectados cortos

INFRAESTRUCTURA





Aplicación



Aplicación

**TBE - TÉS IGUALES A 90° CORTAS**

Con cuello corto para soldadura a tope

PE 100 SDR11 - Máxima presión de trabajo permitida 16 bar (agua) / 10 bar (gas)

| Ref. | Ø | €/Ud. |
|----------|-----|----------|
| TBE11020 | 20 | 1,63 |
| TBE11025 | 25 | 1,63 |
| TBE11032 | 32 | 2,05 |
| TBE11040 | 40 | 3,26 |
| TBE11050 | 50 | 5,00 |
| TBE11063 | 63 | 8,48 |
| TBE11075 | 75 | 13,64 |
| TBE11090 | 90 | 20,38 |
| TBE11110 | 110 | 29,92 |
| TBE11125 | 125 | 41,20 |
| TBE11140 | 140 | 52,20 |
| TBE11160 | 160 | 87,79 |
| TBE11180 | 180 | 112,55 |
| TBE11200 | 200 | 161,27 |
| TBE11225 | 225 | 191,81 |
| TBE11250 | 250 | 244,01 |
| TBE11280 | 280 | 329,89 |
| TBE11315 | 315 | 468,63 |
| TBE11355 | 355 | 858,89 |
| TBE11400 | 400 | 1.282,47 |
| TBE11450 | 450 | 1.568,84 |
| TBE11500 | 500 | 2.005,09 |

PE 100 SDR17 - Máxima presión de trabajo permitida 10 bar (agua) / 5 bar (gas)

| Ref. | Ø | €/Ud. |
|----------|-----|----------|
| TBE17050 | 50 | 3,87 |
| TBE17063 | 63 | 6,99 |
| TBE17075 | 75 | 10,75 |
| TBE17090 | 90 | 15,32 |
| TBE17110 | 110 | 25,46 |
| TBE17125 | 125 | 35,25 |
| TBE17140 | 140 | 41,62 |
| TBE17160 | 160 | 86,44 |
| TBE17180 | 180 | 96,13 |
| TBE17200 | 200 | 131,27 |
| TBE17225 | 225 | 154,11 |
| TBE17250 | 250 | 204,52 |
| TBE17280 | 280 | 254,14 |
| TBE17315 | 315 | 337,08 |
| TBE17355 | 355 | 725,01 |
| TBE17400 | 400 | 990,94 |
| TBE17450 | 450 | 1.275,99 |
| TBE17500 | 500 | 1.642,07 |

TRBE - TÉS REDUCIDAS A 90° CORTAS

Con cuello corto para soldadura a tope

PE 100 SDR11 - Máxima presión de trabajo permitida 16 bar (agua) / 10 bar (gas)

| Ref. | Ø | €/Ud. |
|---------------|---------|--------|
| TRBE11090050 | 90-50 | 30,42 |
| TRBE11110032 | 110-32 | 43,70 |
| TRBE111100500 | 110-50 | 44,47 |
| TRBE11125063 | 125-63 | 62,39 |
| TRBE11140063 | 140-63 | 78,31 |
| TRBE11140075 | 140-75 | 78,31 |
| TRBE11140090 | 140-90 | 79,57 |
| TRBE11140110 | 140-110 | 79,57 |
| TRBE11160110 | 160-110 | 140,05 |
| TRBE11160125 | 160-125 | 140,05 |
| TRBE11180063 | 180-63 | 163,94 |
| TRBE11180075 | 180-75 | 163,94 |
| TRBE11180125 | 180-125 | 169,21 |
| TRBE11225110 | 225-110 | 297,28 |
| TRBE11225125 | 225-125 | 297,28 |
| TRBE11225160 | 225-160 | 308,98 |
| TRBE11250160 | 250-160 | 2,92 |

PE 100 SDR17 - Máxima presión de trabajo permitida 10 bar (agua) / 5 bar (gas)

| Ref. | Ø | €/Ud. |
|--------------|---------|--------|
| TRBE17110090 | 110-90 | 45,50 |
| TRBE17140063 | 140-63 | 60,79 |
| TRBE17140075 | 140-75 | 61,07 |
| TRBE17140090 | 140-90 | 62,06 |
| TRBE17140110 | 140-110 | 63,35 |
| TRBE17160110 | 160-110 | 123,94 |
| TRBE17160125 | 160-125 | 123,94 |
| TRBE17180063 | 180-63 | 140,22 |
| TRBE17180075 | 180-75 | 140,22 |
| TRBE17180125 | 180-125 | 144,49 |
| TRBE17225110 | 225-110 | 247,97 |
| TRBE17225125 | 225-125 | 247,97 |
| TRBE17225160 | 225-160 | 247,97 |



Aplicación



RBE - REDUCCIONES CONCÉNTRICAS CORTAS

Con cuello corto para soldadura a tope

PE 100 SDR11 - Máxima presión de trabajo permitida 16 bar (agua) / 10 bar (gas)

| Ref. | Ø | €/Ud. |
|-------------|---------|-------|
| RBE11025020 | 25-20 | 3,17 |
| RBE11032020 | 32-20 | 3,70 |
| RBE11032025 | 32-25 | 3,70 |
| RBE11040020 | 40-20 | 4,24 |
| RBE11040025 | 40-25 | 4,24 |
| RBE11040032 | 40-32 | 4,24 |
| RBE11050025 | 50-25 | 4,43 |
| RBE11050032 | 50-32 | 4,43 |
| RBE11050040 | 50-40 | 4,43 |
| RBE11063032 | 63-32 | 5,36 |
| RBE11063040 | 63-40 | 5,36 |
| RBE11063050 | 63-50 | 5,36 |
| RBE11075032 | 75-32 | 6,88 |
| RBE11075040 | 75-40 | 6,88 |
| RBE11075063 | 75-63 | 6,88 |
| RBE11090050 | 90-50 | 7,63 |
| RBE11090063 | 90-63 | 7,63 |
| RBE11090075 | 90-75 | 7,63 |
| RBE11110050 | 110-50 | 9,74 |
| RBE11110063 | 110-63 | 9,74 |
| RBE11110075 | 110-75 | 9,74 |
| RBE11110090 | 110-90 | 9,74 |
| RBE11125063 | 125-63 | 12,52 |
| RBE11125075 | 125-75 | 12,52 |
| RBE11125090 | 125-90 | 11,31 |
| RBE11125110 | 125-110 | 12,52 |
| RBE11140075 | 140-75 | 15,16 |
| RBE11140090 | 140-90 | 15,16 |
| RBE11140110 | 140-110 | 13,58 |
| RBE11140125 | 140-125 | 13,58 |
| RBE11160090 | 160-90 | 17,79 |
| RBE11160110 | 160-110 | 17,79 |
| RBE11160125 | 160-125 | 17,79 |
| RBE11160140 | 160-140 | 17,79 |
| RBE11180090 | 180-90 | 27,90 |
| RBE11180110 | 180-110 | 26,24 |
| RBE11180125 | 180-125 | 24,90 |
| RBE11180140 | 180-140 | 22,96 |
| RBE11180160 | 180-160 | 21,95 |
| RBE11200140 | 200-140 | 62,81 |
| RBE11200160 | 200-160 | 40,98 |
| RBE11200180 | 200-180 | 34,35 |
| RBE11225140 | 225-140 | 75,05 |

| Ref. | Ø | €/Ud. |
|-------------|---------|----------|
| RBE11225160 | 225-160 | 52,82 |
| RBE11225180 | 225-180 | 52,82 |
| RBE11225200 | 225-200 | 58,15 |
| RBE11250160 | 250-160 | 85,83 |
| RBE11250180 | 250-180 | 79,18 |
| RBE11250200 | 250-200 | 73,20 |
| RBE11250225 | 250-225 | 79,18 |
| RBE11280200 | 280-200 | 95,79 |
| RBE11280225 | 280-225 | 89,28 |
| RBE11280250 | 280-250 | 86,00 |
| RBE11315200 | 315-200 | 122,23 |
| RBE11315225 | 315-225 | 108,11 |
| RBE11315250 | 315-250 | 156,89 |
| RBE11315280 | 315-280 | 92,28 |
| RBE11355200 | 355-200 | 473,48 |
| RBE11355225 | 355-225 | 206,29 |
| RBE11355250 | 355-250 | 144,85 |
| RBE11355280 | 355-280 | 129,75 |
| RBE11355315 | 355-315 | 123,72 |
| RBE11400225 | 400-225 | 226,30 |
| RBE11400250 | 400-250 | 202,19 |
| RBE11400280 | 400-280 | 187,06 |
| RBE11400315 | 400-315 | 208,23 |
| RBE11400355 | 400-355 | 144,85 |
| RBE11450280 | 450-280 | 862,29 |
| RBE11450315 | 450-315 | 250,47 |
| RBE11450355 | 450-355 | 235,37 |
| RBE11450400 | 450-400 | 211,23 |
| RBE11500280 | 500-280 | 1.397,22 |
| RBE11500315 | 500-315 | 362,14 |
| RBE11500355 | 500-355 | 1.006,89 |
| RBE11500400 | 500-400 | 301,77 |
| RBE11500450 | 500-450 | 271,57 |
| RBE11560355 | 560-355 | 1.615,28 |
| RBE11560400 | 560-400 | 479,83 |
| RBE11560450 | 560-450 | 801,89 |
| RBE11560500 | 560-500 | 374,18 |
| RBE11630355 | 630-355 | 2.248,13 |
| RBE11630400 | 630-400 | 672,95 |
| RBE11630450 | 630-450 | 1.647,66 |
| RBE11630500 | 630-500 | 537,14 |
| RBE11630560 | 630-560 | 446,62 |



Aplicación



RBE - REDUCCIONES CONCÉNTRICAS CORTAS

Con cuello corto para soldadura a tope

PE 100 SDR17 - Máxima presión de trabajo permitida 10 bar (agua) / 5 bar (gas)

| Ref. | Ø | €/Ud. |
|-------------|---------|-------|
| RBE17050032 | 50-32 | 4,24 |
| RBE17050040 | 50-40 | 4,24 |
| RBE17063032 | 63-32 | 5,08 |
| RBE17063040 | 63-40 | 5,08 |
| RBE17063050 | 63-50 | 5,08 |
| RBE17075032 | 75-32 | 6,54 |
| RBE17075040 | 75-40 | 6,54 |
| RBE17075050 | 75-50 | 6,54 |
| RBE17075063 | 75-63 | 6,54 |
| RBE17090050 | 90-50 | 7,33 |
| RBE17090063 | 90-63 | 7,33 |
| RBE17090075 | 90-75 | 7,33 |
| RBE17110050 | 110-50 | 9,32 |
| RBE17110063 | 110-63 | 9,32 |
| RBE17110075 | 110-75 | 9,32 |
| RBE17110090 | 110-90 | 9,32 |
| RBE17125063 | 125-63 | 11,96 |
| RBE17125075 | 125-75 | 11,96 |
| RBE17125090 | 125-90 | 11,96 |
| RBE17125110 | 125-110 | 11,96 |
| RBE17140075 | 140-75 | 14,48 |
| RBE17140090 | 140-90 | 14,48 |
| RBE17140110 | 140-110 | 14,48 |
| RBE17140125 | 140-125 | 14,48 |
| RBE17160090 | 160-90 | 13,58 |
| RBE17160110 | 160-110 | 14,51 |
| RBE17160125 | 160-125 | 16,90 |
| RBE17160140 | 160-140 | 13,14 |
| RBE17180090 | 180-90 | 19,93 |
| RBE17180110 | 180-110 | 20,35 |
| RBE17180125 | 180-125 | 23,07 |
| RBE17180140 | 180-140 | 17,65 |
| RBE17180160 | 180-160 | 18,52 |
| RBE17200140 | 200-140 | 29,55 |
| RBE17200160 | 200-160 | 31,69 |
| RBE17200180 | 200-180 | 29,02 |
| RBE17225140 | 225-140 | 41,20 |
| RBE17225160 | 225-160 | 53,86 |
| RBE17225180 | 225-180 | 58,41 |
| RBE17225200 | 225-200 | 41,20 |
| RBE17250160 | 250-160 | 67,33 |
| RBE17250180 | 250-180 | 67,58 |
| RBE17250200 | 250-200 | 62,03 |
| RBE17250225 | 250-225 | 57,59 |
| RBE17280200 | 280-200 | 84,48 |
| RBE17280225 | 280-225 | 84,48 |

| Ref. | Ø | €/Ud. |
|--------------|----------|----------|
| RBE17280250 | 280-250 | 75,53 |
| RBE17315200 | 315-200 | 122,15 |
| RBE17315225 | 315-225 | 104,66 |
| RBE17315250 | 315-250 | 93,83 |
| RBE17315280 | 315-280 | 87,85 |
| RBE17355200 | 355-200 | 457,48 |
| RBE17355225 | 355-225 | 120,74 |
| RBE17355250 | 355-250 | 104,13 |
| RBE17355280 | 355-280 | 99,58 |
| RBE17355315 | 355-315 | 86,28 |
| RBE17400225 | 400-225 | 150,89 |
| RBE17400250 | 400-250 | 150,89 |
| RBE17400280 | 400-280 | 144,85 |
| RBE17400315 | 400-315 | 179,60 |
| RBE17400355 | 400-355 | 108,59 |
| RBE17450280 | 450-280 | 862,29 |
| RBE17450315 | 450-315 | 765,26 |
| RBE17450355 | 450-355 | 520,77 |
| RBE17450400 | 450-400 | 147,83 |
| RBE17500280 | 500-280 | 1.397,22 |
| RBE17500315 | 500-315 | 251,39 |
| RBE17500355 | 500-355 | 919,71 |
| RBE17500400 | 500-400 | 202,19 |
| RBE17500450 | 500-450 | 196,16 |
| RBE17560355 | 560-355 | 1.819,23 |
| RBE17560400 | 560-400 | 908,23 |
| RBE17560450 | 560-450 | 742,64 |
| RBE17560500 | 560-500 | 635,99 |
| RBE17630355 | 630-355 | 1.965,57 |
| RBE17630400 | 630-400 | 1.213,32 |
| RBE17630450 | 630-450 | 1.007,59 |
| RBE17630500 | 630-500 | 879,60 |
| RBE17630560 | 630-560 | 675,56 |
| RBE17710500 | 710-500 | 1.312,89 |
| RBE17710560 | 710-560 | 1.181,88 |
| RBE17710630 | 70-630 | 961,28 |
| RBE17800560 | 800-560 | 1.638,51 |
| RBE17800630 | 800-630 | 1.379,42 |
| RBE17800710 | 800-710 | 1.250,93 |
| RBE17900630 | 900-630 | 2.285,08 |
| RBE17900710 | 900-710 | 1.960,24 |
| RBE17900800 | 900-800 | 1.364,09 |
| RBE171000710 | 1000-710 | 4.595,58 |
| RBE171000800 | 1000-800 | 2.582,12 |
| RBE171000900 | 1000-900 | 1.052,44 |



Aplicación



REBE - REDUCCIONES EXCÉNTRICAS CORTAS

Con cuello corto para soldadura a tope

PE 100 SDR11 - Máxima presión de trabajo permitida 16 bar (agua) / 10 bar (gas)

PE 100 SDR17 - Máxima presión de trabajo permitida 10 bar (agua) / 5 bar (gas)

| Ref. | Ø | €/Ud. |
|--------------|---------|--------|
| REBE11160090 | 160-90 | 199,47 |
| REBE11160110 | 160-110 | 178,98 |
| REBE11160125 | 160-125 | 159,98 |
| REBE11160140 | 160-140 | 140,95 |
| REBE11180110 | 180-110 | 236,49 |
| REBE11180125 | 180-125 | 210,11 |
| REBE11180140 | 180-140 | 194,78 |
| REBE11180160 | 180-160 | 179,23 |
| REBE11200125 | 200-125 | 397,42 |
| REBE11200140 | 200-140 | 231,80 |
| REBE11200160 | 200-160 | 205,87 |
| REBE11200180 | 200-180 | 194,78 |
| REBE11225140 | 225-140 | 320,41 |
| REBE11225160 | 225-160 | 296,47 |
| REBE11225180 | 225-180 | 257,96 |
| REBE11225200 | 225-200 | 234,80 |
| REBE11250160 | 250-160 | 487,52 |
| REBE11250180 | 250-180 | 366,10 |
| REBE11250200 | 250-200 | 331,55 |
| REBE11250225 | 250-225 | 285,63 |
| REBE11280180 | 280-180 | 546,17 |
| REBE11280200 | 280-200 | 381,14 |
| REBE11280225 | 280-225 | 347,07 |
| REBE11280250 | 280-250 | 307,83 |
| REBE11315200 | 315-200 | 629,81 |
| REBE11315225 | 315-225 | 417,91 |
| REBE11315250 | 315-250 | 362,40 |
| REBE11315280 | 315-280 | 328,07 |

| Ref. | Ø | €/Ud. |
|--------------|---------|--------|
| REBE17160090 | 160-90 | 189,90 |
| REBE17160110 | 160-110 | 164,92 |
| REBE17160125 | 160-125 | 150,10 |
| REBE17160140 | 160-140 | 133,54 |
| REBE17180110 | 180-110 | 363,18 |
| REBE17180125 | 180-125 | 200,00 |
| REBE17180140 | 180-140 | 182,21 |
| REBE17180160 | 180-160 | 167,39 |
| REBE17200125 | 200-125 | 242,92 |
| REBE17200140 | 200-140 | 219,48 |
| REBE17200160 | 200-160 | 193,55 |
| REBE17200180 | 200-180 | 182,43 |
| REBE17225140 | 225-140 | 304,86 |
| REBE17225160 | 225-160 | 285,35 |
| REBE17225180 | 225-180 | 249,09 |
| REBE17225200 | 225-200 | 223,66 |
| REBE17250160 | 250-160 | 487,52 |
| REBE17250180 | 250-180 | 348,05 |
| REBE17250200 | 250-200 | 318,95 |
| REBE17250225 | 250-225 | 265,62 |
| REBE17280180 | 280-180 | 406,57 |
| REBE17280200 | 280-200 | 374,01 |
| REBE17280225 | 280-225 | 336,71 |
| REBE17280250 | 280-250 | 288,58 |
| REBE17315200 | 315-200 | 450,24 |
| REBE17315225 | 315-225 | 398,69 |
| REBE17315250 | 315-250 | 348,78 |
| REBE17315280 | 315-280 | 316,73 |



Aplicación

**GBE - CURVAS CORTAS DE 90°**

Con cuello corto para soldadura a tope

PE 100 SDR11 - Máxima presión de trabajo permitida 16 bar (agua) / 10 bar (gas)

| Ref. | Ø | €/Ud. |
|-----------|-----|----------|
| GBE11020* | 20 | 2,02 |
| GBE11025* | 25 | 2,10 |
| GBE11032* | 32 | 2,19 |
| GBE11040* | 40 | 2,83 |
| GBE11050* | 50 | 3,56 |
| GBE11063* | 63 | 5,08 |
| GBE11075* | 75 | 10,50 |
| GBE11090* | 90 | 12,94 |
| GBE11110* | 110 | 19,39 |
| GBE11125 | 125 | 27,31 |
| GBE11140 | 140 | 36,77 |
| GBE11160 | 160 | 44,49 |
| GBE11180 | 180 | 52,68 |
| GBE11200 | 200 | 92,06 |
| GBE11225 | 225 | 113,78 |
| GBE11250 | 250 | 180,22 |
| GBE11280 | 280 | 249,54 |
| GBE11315 | 315 | 338,51 |
| GBE11355 | 355 | 742,05 |
| GBE11400 | 400 | 1.019,01 |
| GBE11450 | 450 | 1.337,15 |
| GBE11500 | 500 | 1.597,14 |

PE 100 SDR17 - Máxima presión de trabajo permitida 10 bar (agua) / 5 bar (gas)

| Ref. | Ø | €/Ud. |
|-----------|-----|----------|
| GBE17050* | 50 | 3,40 |
| GBE17063* | 63 | 4,69 |
| GBE17075* | 75 | 6,88 |
| GBE17090* | 90 | 11,25 |
| GBE17110* | 110 | 18,89 |
| GBE17125 | 125 | 24,02 |
| GBE17140 | 140 | 34,86 |
| GBE17160 | 160 | 38,45 |
| GBE17180 | 180 | 49,31 |
| GBE17200 | 200 | 60,93 |
| GBE17225 | 225 | 72,58 |
| GBE17250 | 250 | 122,54 |
| GBE17280 | 280 | 168,06 |
| GBE17315 | 315 | 220,01 |
| GBE17355 | 355 | 546,76 |
| GBE17400 | 400 | 761,33 |
| GBE17450 | 450 | 995,27 |
| GBE17500 | 500 | 1.255,92 |



Aplicación



BBEC - UNIONES 3 PIEZAS CORTAS

Con cuello corto para soldadura a tope

PE 100 SDR11 - Máxima presión de trabajo permitida 10 bar (agua)

| Ref. | Ø | €/Ud. |
|------------|-----|--------|
| BBEC11020E | 20 | 16,70 |
| BBEC11025E | 25 | 16,05 |
| BBEC11032E | 32 | 20,35 |
| BBEC11040E | 40 | 23,55 |
| BBEC11050E | 50 | 40,67 |
| BBEC11063E | 63 | 63,37 |
| BBEC11075E | 75 | 112,72 |
| BBEC11110E | 110 | 190,63 |



Aplicación



BBEL - UNIONES 3 PIEZAS LARGAS

Con cuello largo para soldadura a tope y electrofusión

PE 100 SDR11 - Máxima presión de trabajo permitida 10 bar (agua)

| Ref. | Ø | €/Ud. |
|------------|-----|-------|
| BBEL11020E | 20 | 19,98 |
| BBEL11025E | 25 | 22,40 |
| BBEL11032E | 32 | 25,96 |
| BBEL11040E | 40 | 33,93 |
| BBEL11050E | 50 | 45,92 |
| BBEL11063E | 63 | 71,71 |
| BBEL11075E | 75 | 66,24 |
| BBEL11110E | 110 | 99,97 |



Aplicación



DBME - TERMINAL ROSCA HEMBRA LARGO

Con cuello largo para soldadura a tope

PE 100 SDR11 - Máxima presión de trabajo permitida 10 bar (agua)

| Ref. | Ø x Rh | €/Ud. |
|--------------|-------------|-------|
| DBME11020012 | 20 x 1/2" | 5,36 |
| DBME11025034 | 25 x 3/4" | 6,93 |
| DBME11032100 | 32 x 1" | 8,17 |
| DBME11040114 | 40 x 1 1/4" | 9,57 |
| DBME11050112 | 50 x 1 1/2" | 11,98 |
| DBME11063200 | 63 x 2" | 14,17 |



Aplicación



KBFE - TERMINAL ROSCA MACHO CORTO

Con cuello corto para soldadura a tope

PE 100 SDR11 - Máxima presión de trabajo permitida 8 bar (agua)

| Ref. | Ø x Rm | €/Ud. |
|--------------|-------------|-------|
| KBFE11020012 | 20 x 1/2" | 5,50 |
| KBFE11025034 | 25 x 3/4" | 6,60 |
| KBFE11032100 | 32 x 1" | 8,34 |
| KBFE11040114 | 40 x 1 1/4" | 10,05 |
| KBFE11050112 | 50 x 1 1/2" | 16,48 |
| KBFE11063200 | 63 x 2" | 20,83 |



QBE - PORTABRIDAS CORTOS PE 100 SDR 11
Máxima presión de trabajo permitida 16 bar (agua) / 10 bar (gas)

| Ref. | Ø | €/Ud |
|----------|-----|--------|
| QBE11032 | 32 | 2,19 |
| QBE11040 | 40 | 2,58 |
| QBE11050 | 50 | 3,20 |
| QBE11063 | 63 | 3,96 |
| QBE11075 | 75 | 6,37 |
| QBE11090 | 90 | 6,71 |
| QBE11110 | 110 | 13,33 |
| QBE11125 | 125 | 10,44 |
| QBE11140 | 140 | 12,18 |
| QBE11160 | 160 | 15,35 |
| QBE11180 | 180 | 23,83 |
| QBE11200 | 200 | 26,21 |
| QBE11225 | 225 | 48,92 |
| QBE11250 | 250 | 44,37 |
| QBE11280 | 280 | 48,47 |
| QBE11315 | 315 | 57,12 |
| QBE11355 | 355 | 174,83 |
| QBE11400 | 400 | 216,48 |
| QBE11450 | 450 | 403,96 |
| QBE11500 | 500 | 337,98 |
| QBE11560 | 560 | 522,85 |
| QBE11630 | 630 | 886,03 |
| QBE11710 | 710 | 678,96 |
| QBE11800 | 800 | 935,46 |

QBE - PORTABRIDAS CORTOS PE 100 SDR 17
Máxima presión de trabajo permitida 10 bar (agua) / 5 bar (gas)

| Ref. | Ø | €/Ud |
|-----------|------|----------|
| QBE17050 | 50 | 2,89 |
| QBE17063 | 63 | 4,46 |
| QBE17075 | 75 | 5,56 |
| QBE17090 | 90 | 8,48 |
| QBE17110 | 110 | 10,72 |
| QBE17125 | 125 | 10,16 |
| QBE17140 | 140 | 16,31 |
| QBE17160 | 160 | 15,91 |
| QBE17180 | 180 | 26,83 |
| QBE17200 | 200 | 25,20 |
| QBE17225 | 225 | 37,75 |
| QBE17250 | 250 | 59,95 |
| QBE17280 | 280 | 51,08 |
| QBE17315 | 315 | 73,70 |
| QBE17355 | 355 | 116,17 |
| QBE17400 | 400 | 150,77 |
| QBE17450 | 450 | 281,23 |
| QBE17500 | 500 | 248,25 |
| QBE17560 | 560 | 401,38 |
| QBE17630 | 630 | 316,90 |
| QBE17710 | 710 | 543,20 |
| QBE17800 | 800 | 891,25 |
| QBE17900 | 900 | 829,84 |
| QBE171000 | 1000 | 1.308,43 |



**BRIDAS DE ACERO CINCADO
PN10 (DIN 2576) MOP 10 BAR**

| Ref. | PN | Ø Tubo | DN | Nº Agujeros | €/Ud |
|---------------|-------|---------|------|-------------|-----------|
| 311050016055 | 10/16 | 50 | 40 | 4 | 12,27 |
| 311063016055 | 10/16 | 63 | 50 | 4 | 14,29 |
| 311075016055 | 10/16 | 75 | 65 | 4 | 17,48 |
| 311090016055 | 10/16 | 90 | 80 | 8 | 22,04 |
| 311110016055 | 10/16 | 110 | 100 | 8 | 24,31 |
| 311125016055 | 10/16 | 125 | 125 | 8 | 32,68 |
| 311140016055 | 10/16 | 140 | 125 | 8 | 27,44 |
| 311160016055 | 10/16 | 160 | 150 | 8 | 41,26 |
| 311180016055* | 10/16 | 180 | 150 | 8 | 51,50 |
| 311200010055 | 10 | 200 | 200 | 8 | 56,89 |
| 311225010055* | 10 | 225 | 200 | 8 | 73,83 |
| 311250010055 | 10 | 250 | 250 | 12 | 59,36 |
| 311280010055* | 10 | 280 | 250 | 12 | 92,44 |
| 311315010055 | 10 | 315 | 300 | 12 | 76,45 |
| 311355010055 | 10 | 355 | 350 | 16 | 103,88 |
| 311400010055 | 10 | 400 | 400 | 16 | 145,28 |
| 311450010055* | 10 | 450 | 450 | 20 | Consultar |
| 311500010155* | 10 | 450-500 | 500 | 20 | 320,87 |
| 311500010055 | 10 | 500 | 500 | 20 | 207,76 |
| 311560010055* | 10 | 560 | 600 | 20 | 402,35 |
| 311630010055 | 10 | 630 | 600 | 20 | 271,26 |
| 311710010055* | 10 | 710 | 700 | 24 | 523,37 |
| 311800010055* | 10 | 800 | 800 | 24 | 697,38 |
| 311900010055* | 10 | 900 | 900 | 28 | 836,04 |
| 311100010055* | 10 | 1000 | 1000 | 28 | 1.066,88 |

* Galvanizadas

**BRIDAS DE ACERO CINCADO
PN16 (DIN 2502) MOP 16 BAR**

| Ref. | PN | Ø Tubo | DN | Nº Agujeros | €/Ud |
|---------------|----|---------|------|-------------|-----------|
| 311200016055 | 16 | 200 | 200 | 12 | 55,93 |
| 311225016055* | 16 | 225 | 200 | 12 | 71,12 |
| 311250016055 | 16 | 250 | 250 | 12 | 74,42 |
| 311280016055* | 16 | 280 | 250 | 12 | 100,69 |
| 311315016055 | 16 | 315 | 300 | 12 | 97,06 |
| 311355016055 | 16 | 355 | 350 | 16 | 140,32 |
| 311400016055 | 16 | 400 | 400 | 16 | 176,29 |
| 311450016055* | 16 | 450 | 450 | 20 | Consultar |
| 311500016155* | 16 | 450-500 | 500 | 20 | 434,85 |
| 311500016055 | 16 | 500 | 500 | 20 | 349,59 |
| 311560016055* | 16 | 560 | 600 | 20 | 683,87 |
| 311630016055 | 16 | 630 | 600 | 20 | 472,92 |
| 311710016055* | 16 | 710 | 700 | 24 | 680,81 |
| 311800016055* | 16 | 800 | 800 | 24 | 863,77 |
| 311900016055* | 16 | 900 | 900 | 28 | 1.026,41 |
| 311100016055* | 16 | 1000 | 1000 | 28 | 1.368,80 |

* Galvanizadas

**BRIDAS CIEGAS DE ACERO CINCADO
PN10 (DIN 2527) MOP 10/16 Y 10 BAR**

| Ref. | DN Brida | PN | Nº Agujeros | €/Ud |
|--------------|-----------|-------|-------------|--------|
| 312015010055 | 1/2" 15 | 10/16 | 4 | 5,52 |
| 312020010055 | 3/4" 20 | 10/16 | 4 | 7,78 |
| 312025010055 | 1" 25 | 10/16 | 4 | 9,43 |
| 312032010055 | 1 1/4" 32 | 10/16 | 4 | 12,30 |
| 312040010055 | 1 1/2" 40 | 10/16 | 4 | 14,27 |
| 312050010055 | 2" 50 | 10/16 | 4 | 19,64 |
| 312065010055 | 2 1/2" 65 | 10/16 | 4 | 24,38 |
| 312080010055 | 3" 80 | 10/16 | 4 | 31,78 |
| 312100010055 | 4" 100 | 10/16 | 8 | 37,63 |
| 312125010055 | 5" 125 | 10/16 | 8 | 56,51 |
| 312150010055 | 6" 150 | 10/16 | 8 | 69,29 |
| 312200010055 | 8" 200 | 10 | 8 | 109,85 |
| 312250010055 | 10" 250 | 10 | 12 | 159,85 |
| 312300010055 | 12" 300 | 10 | 12 | 205,71 |
| 312350010055 | 14" 350 | 10 | 16 | 268,44 |
| 312400010055 | 16" 400 | 10 | 16 | 329,41 |
| 312450010055 | 18" 450 | 10 | 20 | 419,22 |
| 312500010055 | 20" 500 | 10 | 20 | 499,35 |
| 312600010055 | 24" 600 | 10 | 20 | 729,24 |

**BRIDAS CIEGAS DE ACERO CINCADO
PN16 (DIN 2527) MOP 16 BAR**

| Ref. | DN Brida | PN | Nº Agujeros | €/Ud |
|--------------|----------|----|-------------|--------|
| 312200016055 | 8" 200 | 16 | 12 | 106,16 |
| 312250016055 | 10" 250 | 16 | 12 | 163,87 |
| 312300016055 | 12" 300 | 16 | 12 | 230,42 |
| 312350016055 | 14" 350 | 16 | 16 | 313,24 |
| 312400016055 | 16" 400 | 16 | 16 | 416,49 |
| 312450016055 | 18" 450 | 16 | 20 | 570,46 |
| 312500016055 | 20" 500 | 16 | 20 | 668,90 |
| 312600016055 | 24" 600 | 16 | 20 | 934,54 |



ODB

| d | Ref. | DN | PN | € |
|-----|-------------|------|----|----------|
| 20 | ODB020 | 15 | 16 | 8,85 |
| 25 | ODB025 | 20 | 16 | 9,72 |
| 32 | ODB032 | 25 | 16 | 12,51 |
| 40 | ODB040 | 32 | 16 | 15,18 |
| 50 | ODB050 | 40 | 16 | 17,75 |
| 63 | ODB063 | 50 | 16 | 22,08 |
| 75 | ODB075 | 65 | 16 | 24,40 |
| 90 | ODB090 | 80 | 16 | 29,06 |
| 110 | ODB110 | 100 | 16 | 35,07 |
| 125 | ODB125 | 100 | 16 | 35,07 |
| 140 | ODB140 | 125 | 16 | 52,43 |
| 140 | ODB140DN125 | *125 | 16 | 50,37 |
| 160 | ODB160 | 150 | 16 | 53,41 |
| 180 | ODB180 | 150 | 16 | 61,24 |
| 200 | ODB200PN16 | 200 | 16 | 91,11 |
| 225 | ODB225PN16 | 200 | 16 | 91,11 |
| 250 | ODB250PN16 | 250 | 16 | 114,05 |
| 280 | ODB280PN16 | 250 | 16 | 116,19 |
| 315 | ODB315PN16 | 300 | 16 | 177,41 |
| 355 | ODB355PN16 | 350 | 16 | 332,13 |
| 400 | ODB400PN16 | 400 | 16 | 479,28 |
| 450 | ODB150PN16 | 450 | 16 | 856,97 |
| 500 | ODB500PN16 | 500 | 16 | 856,97 |
| 560 | ODB560PN16 | 600 | 16 | 1.162,16 |
| 630 | ODB630PN16 | 600 | 16 | 1.178,68 |

Brida loca PP con alma de acero

DIN 2501 DIN 16962/16963.

* Para portabridas PVC-U

Ver descuentos aplicables según "Familia PP"

A partir de Ø 75 no utilizar con portabridas socket (sólo testa)



ODB

| d | Ref. | DN | PN | € |
|-----|-------------|------|----|----------|
| 200 | ODB200 | 200 | 10 | 80,21 |
| 225 | ODB225 | 200 | 10 | 80,21 |
| 225 | ODB225DN200 | *200 | 10 | 103,49 |
| 250 | ODB250 | 250 | 10 | 100,41 |
| 280 | ODB280 | 250 | 10 | 102,29 |
| 280 | ODB280DN250 | *250 | 10 | 107,16 |
| 315 | ODB315 | 300 | 10 | 156,19 |
| 315 | ODB315DN300 | *300 | 10 | 156,94 |
| 355 | ODB355 | 350 | 10 | 292,39 |
| 400 | ODB400 | 400 | 10 | 421,93 |
| 450 | ODB450 | 450 | 10 | 754,43 |
| 500 | ODB500 | 500 | 10 | 754,43 |
| 560 | ODB560 | 600 | 10 | 1.023,11 |
| 630 | ODB630 | 600 | 10 | 1.037,63 |

Brida loca PP con alma de acero

DIN 2501 DIN 16962/16963.

* Para portabridas PVC-U

Ver descuentos aplicables según "Familia PP"

A partir de Ø 75 no utilizar con portabridas socket (sólo testa)



OAB

| d | Ref. | DN | € |
|-----|--------|-----|--------|
| ½" | OAB012 | 15 | 10,99 |
| ¾" | OAB034 | 20 | 13,68 |
| 1" | OAB100 | 25 | 16,14 |
| 1¼" | OAB114 | 32 | 18,59 |
| 1½" | OAB112 | 40 | 23,19 |
| 2" | OAB200 | 50 | 28,81 |
| 2½" | OAB212 | 65 | 35,60 |
| 3" | OAB300 | 80 | 41,73 |
| 4" | OAB400 | 100 | 54,44 |
| 6" | OAB600 | 150 | 102,85 |
| 8" | OAB800 | 200 | 148,79 |
| 10" | OAB810 | 250 | 191,63 |
| 12" | OAB812 | 300 | 295,58 |
| 14" | OAB814 | 350 | 557,70 |
| 16" | OAB816 | 400 | 680,04 |

Brida loca PP con alma de acero

ANSI 150 lbs.

Ver descuentos aplicables según "Familia PP"

A partir de Ø 75 no utilizar con portabridas socket (sólo testa)



ODBC

| d | Ref. | DN | PN | € |
|---------|---------|-----|----|----------|
| 20 | ODBC020 | 15 | 16 | 67,53 |
| 25 | ODBC025 | 20 | 16 | 68,59 |
| 32 | ODBC032 | 25 | 16 | 70,33 |
| 40 | ODBC040 | 32 | 16 | 75,32 |
| 50 | ODBC050 | 40 | 16 | 85,30 |
| 63 | ODBC063 | 50 | 16 | 92,89 |
| 75 | ODBC075 | 65 | 16 | 108,81 |
| 90 | ODBC090 | 80 | 16 | 119,75 |
| 110/125 | ODBC110 | 100 | 16 | 163,58 |
| 140 | ODBC140 | 125 | 16 | 200,88 |
| 160/180 | ODBC160 | 150 | 16 | 253,51 |
| 200/225 | ODBC200 | 200 | 10 | 281,56 |
| 250/280 | ODBC250 | 250 | 10 | 367,93 |
| 315 | ODBC315 | 300 | 10 | 537,13 |
| 355 | ODBC355 | 350 | 10 | 1.050,68 |
| 400 | ODBC400 | 400 | 10 | 1.200,24 |

Brida ciega PP con alma de acero DIN 2501

Ver descuentos aplicables según "Familia PP"



OABC

| d | Ref. | DN | € |
|-----|---------|-----|--------|
| ½" | OABC012 | 15 | 78,52 |
| ¾" | OABC034 | 20 | 79,63 |
| 1" | OABC100 | 25 | 81,59 |
| 1¼" | OABC114 | 32 | 87,42 |
| 1½" | OABC112 | 40 | 99,25 |
| 2" | OABC200 | 50 | 108,02 |
| 2½" | OABC212 | 65 | 123,41 |
| 3" | OABC300 | 80 | 139,15 |
| 4" | OABC400 | 100 | 190,13 |
| 6" | OABC600 | 150 | 294,77 |
| 8" | OABC800 | 200 | 327,32 |
| 10" | OABC810 | 250 | 427,45 |
| 12" | OABC812 | 300 | 624,68 |

Brida ciega PP con alma de acero ANSI 150 lbs.

Ver descuentos aplicables según "Familia PP"

Uniones y adaptadores brida
Carretes de desmontaje
Abrazaderas de reparación

Accesorios metálicos

INFRAESTRUCTURA





Accesorios metálicos

Uniones y adaptadores bridas

Selector de productos según el material de las tuberías para uniones, uniones reducidas y adaptadores de brida

NOTA: Esta tabla sirve de orientación sobre qué productos Viking Johnson son compatibles con qué materiales de tubería. Consulte la documentación del producto para obtener más detalles sobre su idoneidad final.

Grupos de productos

| Grupos de productos | | Rango de diámetros nominales (mm) | Fundición dúctil | Fundición | Acero | Acero inoxidable | PVC | HEP30 | Polipropileno | PEMD/PE80 | PEAD/PE100 | PPRV | ABS | Cerámica | Hormigón | Fibras de carbono | Cobre | Plomo |
|------------------------|--------------------|-----------------------------------|------------------|-----------|-------|------------------|-----|-------|---------------|-----------|------------|------|-----|----------|----------|-------------------|-------|-------|
| Gran tolerancia | | | | | | | | | | | | | | | | | | |
| MaxiFit (A, C) | Unión | 40 - 700 | ● | ● | ● | ● | ● | ● | 8 | 8 | 8 | 6 | ● | 1 | ● | 6 | 1 | 1 |
| | Adaptador de Brid | 40 - 700 | ● | ● | ● | ● | ● | ● | 8 | 8 | 8 | 6 | ● | 1 | ● | 6 | 1 | 1 |
| | Unión Reducida | 40 - 700 | ● | ● | ● | ● | ● | ● | 8 | 8 | 8 | 6 | ● | 1 | ● | 6 | 1 | 1 |
| MegaFit (A, C) | Unión | 50 - 300 | ● | ● | ● | ● | ● | ● | | | | 6 | ● | 1 | ● | 6 | | |
| | Adaptador de Brida | 50 - 300 | ● | ● | ● | ● | ● | ● | | | | 6 | ● | 1 | ● | 6 | | |
| | Unión Reducida | 50 - 300 | ● | ● | ● | ● | ● | ● | | | | 6 | ● | 1 | ● | 6 | | |
| UltraGrip (A, B) | Unión | 40 - 800 | ● | ● | ● | | ● | ● | 3 | 3 | 3 | 2 | | | | 2 | | |
| | Adaptador de Brida | 40 - 800 | ● | ● | ● | | ● | ● | 5 | 5 | 3 | 3 | 2 | | | 2 | | |
| | Uniones Reducidas | 40 - 600 | ● | ● | ● | | ● | ● | 5 | 5 | 3 | 3 | 2 | | | 2 | | |
| | Tapones | 50 - 300 | ● | ● | ● | | ● | ● | 5 | 5 | 3 | 3 | 2 | | | | | |
| | Pecataadaptor | 80 - 200 | ● | ● | ● | | ● | ● | 5 | 5 | | | | | | | | |

Específicos

| | | | | | | | | | | | | | | | | | | |
|-----------------------------------|--------------------|---------------|---|---|---|---|---|---|--|--|--|---|---|--|---|---|--|--|
| FlexLock (A, B) | Unión | 50 - 300 | ● | | ● | | | | | | | | | | | | | |
| | Adaptador de Brid | 50 - 300 | ● | | ● | | | | | | | | | | | | | |
| QuickFit (A, C) | Unión | 40 - 300 | ● | | ● | | ● | ● | | | | | ● | | ● | | | |
| | Adaptador de Brida | 40 - 300 | ● | | ● | | ● | ● | | | | | ● | | ● | | | |
| Gran Diámetro, Desmontadas (A, C) | Unión | 350 y mayores | ● | ● | ● | ● | ● | ● | | | | 6 | ● | | ● | 6 | | |
| | Adaptador de Brida | 350 y mayores | ● | ● | ● | ● | ● | ● | | | | 6 | ● | | ● | 6 | | |
| | Unión Reducida | 350 y mayores | ● | ● | ● | ● | ● | ● | | | | 6 | ● | | ● | 6 | | |

Soluciones para PE

| | | | | | | | | | | | | | | | | | | |
|-----------------|-------------------------------------|---------------|--|--|--|--|---|---|---|---|---|---|--|--|--|--|--|--|
| AquaFast (A, B) | Unión | 63 - 315 | | | | | ● | ● | ● | ● | ● | | | | | | | |
| | Unión de Gran Diámetro | 355 - 450 | | | | | | | | ● | ● | | | | | | | |
| | Adaptador de Brida | 63 - 315 | | | | | ● | ● | ● | ● | ● | | | | | | | |
| | Adaptador de Brida de Gran Diámetro | 355 - 450 | | | | | | | | ● | ● | | | | | | | |
| AquaGrip (A, B) | Unión | 63 - 180 | | | | | | | ● | ● | ● | | | | | | | |
| | Adaptador de Brida | 63 - 180 | | | | | | | ● | ● | ● | | | | | | | |
| | Adaptador de Brida | 225 - 800 | | | | | | | | ● | ● | | | | | | | |
| | Adaptador de Brida | 900 y mayores | | | | | | | | | ● | ● | | | | | | |

Reparaciones de tuberías

| | | | | | | | | | | | | | | | | | | |
|----------------|----------------------------|------------|---|---|---|---|---|---|---|---|---|---|---|--|---|---|---|---|
| EasiRange (A) | EasiClamp / Toma | 50 - 600 | ● | ● | ● | | 4 | 4 | 4 | 4 | 4 | | | | | | | |
| | Universal EasiTee | 80 - 300 | ● | ● | ● | | | | | | | | | | | | | |
| | Mattseal Easitee/ Toma | 350 - 600 | ● | ● | ● | | | | | | | | | | | | | |
| | Ringseal Easite | 350 - 1200 | ● | ● | ● | | ● | | | | | | | | | | | |
| | EasiCollar | 300 - 1200 | ● | ● | | | | | | | | | | | ● | ● | | |
| HandiRange (A) | HandiBand | 15 - 50 | | | ● | | ● | ● | | | | ● | | | | | ● | |
| | HandiClamp / conexión en T | 50 - 600 | ● | ● | ● | ● | ● | ● | 7 | 7 | 7 | 7 | ● | | ● | ● | ● | ● |

Nota: Un producto Viking Johnson es apto hasta la presión máxima de trabajo indicada con un material de tubería concreto. (1) Contacte con el departamento de marketing de Viking Johnson para obtener más información.

- (2) Solo en versión Flex.
- (3) Solo en versión autoblocante con casquillo rigidizador
- (4) Disponible hasta DN200 (rendimiento limitado).
- (5) Puede ser necesario un casquillo rigidizador - consultar la documentación técnica.
- (6) Puede ser necesario un par de apriete menor - ponerse en contacto con Viking Johnson.
- (7) Rendimiento limitado.
- (8) Tramos cortos de hasta 1 m de PE cuando se utiliza con casquillo rigidizador.



Aplicación



Válido para



AQUAFast - UNIONES

| Ref. | Ø | Presión Máx. Trabajo (bar) | €/Ud. |
|-------------|-----|----------------------------|---------|
| 70700000063 | 63 | 16 | 166,14 |
| 70700000075 | 75 | 16 | 182,68 |
| 70700000090 | 90 | 16 | 198,28 |
| 70700000110 | 110 | 16 | 215,90 |
| 70700000125 | 125 | 16 | 260,92 |
| 70700000140 | 140 | 16 | 293,19 |
| 70700000160 | 160 | 16 | 339,18 |
| 70700000180 | 180 | 16 | 490,49 |
| 70700000200 | 200 | 16 | 643,12 |
| 70700000225 | 225 | 16 | 797,04 |
| 70700000250 | 250 | 16 | 978,21 |
| 70700000280 | 280 | 16 | 1179,89 |
| 70700000315 | 315 | 16 | 1374,79 |

Material: Cuerpo de fundición revestido con Rilsan Nylon 11.

Anillo: Fundición Dúctil

Tornillos y Tuercas: Sheraplex.

EPDM para Aplicaciones en Agua



Aplicación



Válido para



AQUAFast - ADAPTADORES DE BRIDA

| Ref. | Ø | Presión Máx. Trabajo (bar) | Brida | | €/Ud. |
|-------------|-----|----------------------------|-----------|------------|--------|
| | | | DN | Taladro PN | |
| 70800000063 | 63 | 16 | 50 / 65 | 10 / 16 | 116,99 |
| 70800000075 | 75 | 16 | 65 / 80 | 10 / 16 | 125,59 |
| 70800000090 | 90 | 16 | 65 / 80 | 10 / 16 | 144,95 |
| 70800000110 | 110 | 16 | 100 | 10 / 16 | 162,01 |
| 70800000125 | 125 | 16 | 100 / 125 | 10 / 16 | 195,99 |
| 70800000140 | 140 | 16 | 125 | 10 / 16 | 228,90 |
| 70800000160 | 160 | 16 | 150 | 10 / 16 | 259,16 |
| 70800000180 | 180 | 16 | 150 | 10 / 16 | 342,61 |
| 70800000200 | 200 | 16 | 200 | 10 / 16 | 438,16 |
| 70800000225 | 225 | 16 | 200 | 10 / 16 | 531,36 |
| 70800000250 | 250 | 16 | 250 | 10 / 16 | 640,51 |
| 70800000280 | 280 | 16 | 250 | 10 / 16 | 773,20 |
| 70800000315 | 315 | 16 | 300 | 10 / 16 | 909,00 |

Material: Cuerpo de fundición revestido con Rilsan Nylon 11.

Anillo: Fundición Dúctil

Tornillos y Tuercas: Sheraplex.

EPDM para Aplicaciones en Agua



Aplicación



Válido para



AQUAFast - UNIONES PARA GRANDES DIÁMETROS

| Ref. | Ø | Presión Máx. Trabajo (bar) | €/Ud. |
|--------------|-----|----------------------------|---------|
| 707000000355 | 355 | 16 | 4279,94 |
| 707000000400 | 400 | 16 | 4698,44 |
| 707000000450 | 450 | 16 | 6303,35 |

Material: Cuerpo de fundición revestido con Rilsan Nylon 11

Anillo antitracción: Fundición Dúctil

Tornillos y tuercas: Acero Inoxidable

Junta: EPDM para Aplicaciones en Agua. Ideal para tubos con ovalación

AQUAFast - ADAPTADORES DE BRIDA PARA GRANDES DIÁMETROS

| Ref. | Ø | Presión Máx. Trabajo (bar) | Brida | | €/Ud. |
|--------------|-----|----------------------------|-------|------------|---------|
| | | | DN | Taladro PN | |
| 708000300355 | 355 | 16 | 300 | 10 / 16 | 2644,74 |
| 708000350355 | 355 | 16 | 350 | 10 / 16 | 2697,66 |
| 708000350400 | 400 | 16 | 350 | 10 / 16 | 3049,93 |
| 708000400400 | 400 | 16 | 400 | 10 / 16 | 3110,98 |
| 708000400450 | 450 | 16 | 400 | 10 / 16 | 4272,71 |
| 708000450450 | 450 | 16 | 450 | 10 / 16 | 4358,15 |
| 708000500450 | 450 | 16 | 500 | 10 / 16 | 4445,30 |



Aplicación



Válido para



AQUAGRIP - ADAPTADORES DE BRIDA ANTITRACCIÓN-AUTOBLOCANTE DE GRAN DIÁMETRO

SDR11

| Ref. | Ø Tubo | Brida | | €/Ud.* |
|--------------|--------|-------|------------|--------|
| | | DN | Taladro PN | |
| 161355300110 | 355 | 300 | 10 | |
| 161355300100 | 355 | 300 | 16 | |
| 161355350100 | 355 | 350 | 16 | |
| 161400300100 | 400 | 300 | 16 | |
| 161400350100 | 400 | 350 | 16 | |
| 161400400110 | 400 | 400 | 10 | |
| 161400400100 | 400 | 400 | 16 | |
| 161450350100 | 450 | 350 | 16 | |
| 161450400110 | 450 | 400 | 10 | |
| 161450400100 | 450 | 400 | 16 | |
| 161450450110 | 450 | 450 | 10 | |
| 161450450100 | 450 | 450 | 16 | |
| 161450500110 | 450 | 500 | 10 | |

Material: Cuerpo de fundición revestido con Rilsan Nylon 11

Tornillos y tuercas: hasta d800 Fluoreno, d900 en adelante galvanizado

Junta: EPDM para Aplicaciones en Agua. Ideal para tubos con ovalación



Aplicación



Válido para



MAXIFIT - UNIONES

| Ref. | DN | Tolerancia (mm) | Presión Máx. de Trabajo (bar) | | €/Ud.* |
|--------------|-----|-----------------|-------------------------------|-----|---------|
| | | | Agua | Gas | |
| 701000000005 | 40 | 047.9 - 059.5 | 16 | 6 | 88,38 |
| 701000000010 | 50 | 057.0 - 074.0 | 16 | 6 | 71,43 |
| 701000000015 | 65 | 063.0 - 085.0 | 16 | 6 | 77,39 |
| 701000000020 | 80 | 085.0 - 107.0 | 16 | 6 | 88,04 |
| 701000000030 | 100 | 107.0 - 132.0 | 16 | 6 | 106,15 |
| 701000000035 | 125 | 132.0 - 158.0 | 16 | 6 | 135,33 |
| 701000000045 | 150 | 158.0 - 184.0 | 16 | 6 | 142,92 |
| 701000000050 | 175 | 189.0 - 212.0 | 16 | 6 | 174,45 |
| 701000000055 | 200 | 218.0 - 244.0 | 16 | 6 | 192,72 |
| 701000000065 | 225 | 243.0 - 269.0 | 16 | 6 | 229,31 |
| 701000000070 | 250 | 266.0 - 295.0 | 16 | 6 | 257,86 |
| 701000000075 | 300 | 315.0 - 349.0 | 16 | 6 | 291,28 |
| 701000000090 | 350 | 351.0 - 368.0 | 16 | 6 | 1060,11 |
| 701000000095 | 350 | 374.5 - 391.5 | 16 | 6 | 1060,11 |
| 701000000096 | 350 | 386.0 - 403.0 | 16 | 6 | 1050,55 |
| 701000000097 | 350 | 394.3 - 411.3 | 16 | 6 | 1050,55 |
| 701000000098 | 400 | 404.8 - 421.8 | 16 | 6 | 1148,84 |
| 701000000099 | 400 | 412.0 - 429.0 | 16 | 6 | 1148,84 |
| 701000000100 | 400 | 418.2 - 435.2 | 16 | 6 | 1148,84 |
| 701000000101 | 400 | 425.0 - 442.0 | 16 | 6 | 1117,23 |
| 701000000102 | 400 | 434.5 - 451.5 | 16 | 6 | 1395,78 |
| 701000000103 | 400 | 439.0 - 456.0 | 16 | 6 | 1148,84 |
| 701000000104 | 450 | 447.0 - 464.0 | 16 | 6 | 1229,53 |
| 701000000105 | 450 | 455.0 - 472.0 | 16 | 6 | 1229,53 |
| 701000000106 | 450 | 467.0 - 484.0 | 16 | 6 | 1229,53 |
| 701000000110 | 450 | 476.0 - 493.0 | 16 | 6 | 1229,53 |
| 701000000111 | 450 | 487.0 - 504.3 | 16 | 6 | 1383,20 |
| 701000000112 | 450 | 492.0 - 509.0 | 16 | 6 | 1229,53 |
| 701000000115 | 450 | 501.9 - 518.9 | 16 | 6 | 1383,20 |
| 701000000118 | 500 | 510.0 - 527.0 | 16 | 6 | 1388,42 |
| 701000000119 | 500 | 515.0 - 532.0 | 16 | 6 | 1561,90 |
| 701000000120 | 500 | 527.0 - 545.0 | 16 | 6 | 1350,24 |
| 701000000121 | 500 | 546.0 - 563.0 | 16 | 6 | 1350,24 |
| 701000000122 | 500 | 555.3 - 572.3 | 16 | 6 | |
| 701000001122 | 500 | 565.0 - 582.0 | 16 | 6 | 1518,92 |
| 701000002122 | 500 | 582.2 - 599.2 | 16 | 6 | 1561,90 |
| 701000003122 | 550 | 593.0 - 610.0 | 16 | 6 | 1377,53 |
| 701000000123 | 600 | 601.0 - 618.0 | 16 | 6 | 1561,90 |
| 701000000124 | 600 | 613.0 - 630.0 | 16 | 6 | 1477,08 |
| 701000000125 | 600 | 630.0 - 647.0 | 16 | 6 | 1477,08 |
| 701000000126 | 600 | 654.0 - 671.0 | 16 | 6 | 1477,08 |
| 701000000130 | 600 | 662.0 - 679.0 | 16 | 6 | 1719,45 |
| 701000000131 | 600 | 675.0 - 692.0 | 16 | 6 | 1477,08 |
| 701000000132 | 600 | 689.0 - 706.0 | 16 | 6 | 1610,93 |
| 701000000133 | 600 | 695.0 - 712.0 | 16 | 6 | 1610,93 |

* Precios con Junta de EPDM, para Nitrilo consultar

MAXIFIT-XTRA - UNIONES

Material: Cuerpo de fundición revestido con Rilsan Nylon 11.

Revestimiento de tornillos y tuercas: Sheraplex.

Juntas: EPDM para Aplicaciones en Agua, Nitrilo para Aplicaciones en Gas.

Uniones de gran tolerancia (iguales que Maxi-fit) pero con un 50% más de longitud para incrementar seguridad de unión. Disponibles desde DN50 a DN300



Aplicación



Válido para



MAXISTEP - UNIONES REDUCIDAS

| Ref. | DN | Tolerancia (mm) | | Presión Máx. de Trabajo (bar) | | €/Ud. |
|--------------|-----------|-----------------|---------------|-------------------------------|-----|---------|
| | | Extremo Peq. | Extremo Gran. | Agua | Gas | |
| 70300000010 | 050 / 065 | 057.0 - 074.0 | 063.0 - 085.0 | 16 | 6 | 221,32 |
| 70300000015 | 050 / 080 | 057.0 - 074.0 | 085.0 - 107.0 | 16 | 6 | 230,73 |
| 70300000016 | 065 / 080 | 063.0 - 085.0 | 085.0 - 107.0 | 16 | 6 | 233,49 |
| 70300000020 | 080 / 100 | 085.0 - 107.0 | 107.0 - 132.0 | 16 | 6 | 240,82 |
| 70300000040 | 100 / 125 | 107.0 - 132.0 | 132.0 - 158.0 | 16 | 6 | 252,12 |
| 70300000050 | 125 / 150 | 132.0 - 158.0 | 158.0 - 184.0 | 16 | 6 | 280,31 |
| 70300000065 | 150 / 175 | 158.0 - 184.0 | 189.0 - 212.0 | 16 | 6 | 332,25 |
| 70300000075 | 175 / 200 | 189.0 - 212.0 | 218.0 - 244.0 | 16 | 6 | 421,48 |
| 70300000080 | 200 / 225 | 218.0 - 244.0 | 243.0 - 269.0 | 16 | 6 | 484,98 |
| 70300000085 | 225 / 250 | 243.0 - 269.0 | 266.0 - 295.0 | 16 | 6 | 495,59 |
| 70300000090 | 300 / 350 | 315.0 - 332.0 | 351.0 - 368.0 | 16 | 6 | 1969,32 |
| 70300000095 | 300 / 350 | 315.0 - 332.0 | 367.0 - 384.0 | 16 | 6 | 2057,11 |
| 70300000100 | 350 / 350 | 351.0 - 368.0 | 374.5 - 391.5 | 16 | 6 | 2325,77 |
| 70300000115 | 350 / 350 | 374.5 - 391.5 | 394.3 - 411.3 | 16 | 6 | 1284,49 |
| 70300000116 | 350 / 400 | 374.5 - 391.5 | 412.0 - 429.0 | 16 | 6 | 2550,43 |
| 70300000117 | 350 / 400 | 386.0 - 403.0 | 412.0 - 429.0 | 16 | 6 | 1348,98 |
| 70300000118 | 350 / 400 | 394.3 - 411.3 | 404.8 - 421.8 | 16 | 6 | 2507,81 |
| 703000002118 | 350 / 400 | 394.3 - 411.3 | 418.2 - 435.2 | 16 | 6 | 1348,98 |
| 703000003118 | 350 / 400 | 394.3 - 411.3 | 425.0 - 442.0 | 16 | 6 | 2626,58 |
| 703000000119 | 400 / 400 | 404.8 - 421.8 | 418.2 - 435.2 | 16 | 6 | 1348,98 |
| 703000000120 | 400 / 400 | 404.8 - 421.8 | 425.0 - 442.0 | 16 | 6 | 1373,73 |
| 703000000121 | 400 / 400 | 404.8 - 421.8 | 434.5 - 451.4 | 16 | 6 | 2681,68 |
| 703000000122 | 400 / 400 | 412.0 - 429.0 | 425.0 - 442.0 | 16 | 6 | 2626,58 |
| 703000000123 | 400 / 400 | 418.2 - 435.2 | 434.5 - 451.4 | 16 | 6 | 2681,68 |
| 703000000125 | 400 / 400 | 425.0 - 442.0 | 434.5 - 451.4 | 16 | 6 | 1373,73 |
| 703000000130 | 400 / 400 | 425.0 - 442.0 | 447.2 - 464.2 | 16 | 6 | 1373,73 |
| 703000000131 | 400 / 400 | 439.0 - 456.0 | 467.0 - 484.0 | 16 | 6 | 1476,26 |
| 703000000135 | 400 / 450 | 425.0 - 442.0 | 455.0 - 472.0 | 16 | 6 | 2927,78 |
| 703000000136 | 400 / 450 | 425.0 - 442.0 | 476.0 - 493.0 | 16 | 6 | 2995,94 |
| 703000000137 | 400 / 450 | 425.0 - 442.0 | 487.3 - 504.3 | 16 | 6 | 3681,93 |
| 703000001137 | 400 / 500 | 425.0 - 442.0 | 555.3 - 572.3 | 16 | 6 | 3744,85 |
| 703000002137 | 400 / 500 | 425.0 - 442.0 | 565.0 - 582.0 | 16 | 6 | 1480,08 |
| 703000002138 | 450 / 450 | 447.2 - 464.2 | 455.0 - 472.0 | 16 | 6 | 2804,62 |
| 703000000139 | 450 / 450 | 447.2 - 464.2 | 476.0 - 493.0 | 16 | 6 | 2927,78 |
| 703000000140 | 450 / 450 | 476.0 - 493.0 | 487.3 - 504.3 | 16 | 6 | 1632,58 |
| 703000000145 | 450 / 450 | 476.0 - 493.0 | 501.9 - 518.9 | 16 | 6 | 1632,58 |
| 703000000150 | 450 / 450 | 476.0 - 493.0 | 510.0 - 527.0 | 16 | 6 | 1632,58 |
| 703000000151 | 450 / 500 | 492.0 - 509.0 | 527.0 - 544.0 | 16 | 6 | 1994,28 |
| 703000000154 | 500 / 500 | 510.0 - 527.0 | 527.0 - 544.0 | 16 | 6 | 1994,28 |
| 703000000155 | 500 / 500 | 527.0 - 544.0 | 540.1 - 557.1 | 16 | 6 | 1805,83 |
| 703000000160 | 500 / 500 | 527.0 - 544.0 | 555.3 - 572.3 | 16 | 6 | 1805,83 |



Aplicación



Válido para

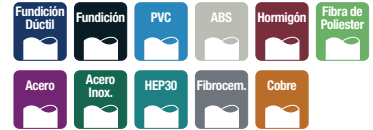

MAXISTEP - UNIONES REDUCIDAS

| Ref. | DN | Tolerancia (mm) | | Presión Máx. de Trabajo (bar) | | €/Ud. |
|--------------|-----------|-----------------|---------------|-------------------------------|-----|---------|
| | | Extremo Peq. | Extremo Gran. | Agua | Gas | |
| 70300000165 | 500 / 500 | 527.0 - 544.0 | 566.5 - 583.5 | 16 | 6 | 1805,83 |
| 70300000170 | 500 / 500 | 527.0 - 544.0 | 582.2 - 599.2 | 16 | 6 | 1805,83 |
| 70300000171 | 500 / 600 | 527.0 - 544.0 | 598.0 - 615.0 | 16 | 6 | 3956,90 |
| 703000001171 | 500 / 600 | 527.0 - 544.0 | 601.0 - 618.0 | 16 | 6 | 3977,97 |
| 703000002171 | 500 / 500 | 546.0 - 563.0 | 590.5 - 607.5 | 16 | 6 | 1899,74 |
| 703000003171 | 500 / 500 | 565.0 - 582.0 | 582.2 - 599.2 | 16 | 6 | 3854,85 |
| 703000000172 | 600 / 600 | 601.0 - 618.0 | 630.0 - 647.0 | 16 | 6 | 1899,74 |
| 703000000173 | 600 / 600 | 601.0 - 618.0 | 645.2 - 662.2 | 16 | 6 | 1899,74 |
| 703000000174 | 600 / 600 | 618.0 - 635.0 | 630.0 - 647.0 | 16 | 6 | 1899,74 |
| 703000000175 | 600 / 600 | 630.0 - 647.0 | 645.2 - 662.2 | 16 | 6 | 1899,74 |
| 703000000180 | 600 / 600 | 630.0 - 647.0 | 662.0 - 679.0 | 16 | 6 | 1899,74 |
| 703000000185 | 600 / 600 | 630.0 - 647.0 | 675.0 - 692.0 | 16 | 6 | 1899,74 |
| 703000000186 | 600 / 600 | 654.0 - 671.0 | 710.0 - 727.0 | 16 | 6 | 2216,53 |
| 703000000190 | 700 / 700 | 733.0 - 750.0 | 741.0 - 758.0 | 16 | 6 | 2435,13 |

* Precios con Junta de EPDM, para Nitrilo consultar



Aplicación



Válido para



MAXIDAPTOR - ADAPTADORES DE BRIDA

| Ref. | DN | Tolerancia (mm) | Brida | | Presión Máx. de Trabajo (bar) | | €/Ud. |
|--------------|-----|-----------------|--------------|------------|-------------------------------|-----|---------|
| | | | DN | Taladro PN | Agua | Gas | |
| 702000000005 | 50 | 057.0 - 074.0 | 50 | 10 / 16 | 16 | 6 | 74,92 |
| 702000000010 | 65 | 063.0 - 085.0 | 60 / 65 / 80 | 10 / 16 | 16 | 6 | 97,52 |
| 702000000020 | 80 | 085.0 - 107.0 | 80 | 10 / 16 | 16 | 6 | 99,17 |
| 702000000030 | 100 | 107.0 - 132.0 | 100 | 10 / 16 | 16 | 6 | 104,00 |
| 702000000035 | 125 | 132.2 - 158.0 | 125 / 150 | 10 / 16 | 16 | 6 | 140,89 |
| 702000000045 | 150 | 158.0 - 184.0 | 150 | 10 / 16 | 16 | 6 | 143,86 |
| 702000000050 | 175 | 189.0 - 212.0 | 200 | 10 / 16 | 16 | 6 | 191,91 |
| 702000000055 | 200 | 218.0 - 244.0 | 200 | 10 / 16 | 16 | 6 | 201,40 |
| 702000000060 | 225 | 243.0 - 269.0 | 250 | 10 / 16 | 16 | 6 | 251,82 |
| 702000000065 | 250 | 266.0 - 295.0 | 250 | 10 / 16 | 16 | 6 | 266,62 |
| 702000000070 | 300 | 315.0 - 349.0 | 300 | 10 / 16 | 16 | 6 | 315,19 |
| 702000000075 | 350 | 348.5 - 365.5 | 350 | 16 | 16 | 6 | 1335,32 |
| 702000000080 | 350 | 351.0 - 368.0 | 350 | 10 | 16 | 6 | 1335,32 |
| 702000000084 | 350 | 351.0 - 368.0 | 350 | 16 | 16 | 6 | 1335,32 |
| 702000000085 | 350 | 374.5 - 391.5 | 350 | 10 | 16 | 6 | 1335,32 |
| 702000000090 | 350 | 374.5 - 391.5 | 350 | 16 | 16 | 6 | 1335,32 |
| 702000000095 | 350 | 394.3 - 411.3 | 350 | 10 | 16 | 6 | 1422,67 |
| 702000000100 | 350 | 394.3 - 411.3 | 350 | 16 | 16 | 6 | 1422,67 |
| 702000000101 | 350 | 394.3 - 411.3 | 400 | 10 | 16 | 6 | |
| 702000000102 | 350 | 394.3 - 411.3 | 400 | 16 | 16 | 6 | 1376,61 |
| 702000000104 | 400 | 404.8 - 421.8 | 400 | 10 | 16 | 6 | 1376,61 |
| 702000000105 | 400 | 404.8 - 421.8 | 400 | 16 | 16 | 6 | 1376,61 |
| 702000000106 | 400 | 418.2 - 435.2 | 400 | 10 | 16 | 6 | 1376,61 |
| 702000000107 | 400 | 418.2 - 435.2 | 400 | 16 | 16 | 6 | 1376,61 |
| 702000000108 | 400 | 425.0 - 442.0 | 400 | 10 | 16 | 6 | 1376,61 |
| 702000000110 | 400 | 425.0 - 442.0 | 400 | 16 | 16 | 6 | 1376,61 |
| 702000000111 | 400 | 434.4 - 451.4 | 400 | 10 | 16 | 6 | 1376,61 |
| 702000000115 | 400 | 434.4 - 451.4 | 400 | 16 | 16 | 6 | 1376,61 |
| 702000000116 | 400 | 447.2 - 464.2 | 400 | 10 | 16 | 6 | 1492,37 |
| 702000000120 | 400 | 447.2 - 464.2 | 400 | 16 | 16 | 6 | 1492,37 |
| 702000000125 | 450 | 455.0 - 472.0 | 450 | 10 | 16 | 6 | 1705,09 |
| 702000000130 | 450 | 455.0 - 472.0 | 450 | 16 | 16 | 6 | 1705,09 |
| 702000000131 | 450 | 476.0 - 493.0 | 450 | 10 | 16 | 6 | 1705,09 |
| 702000000135 | 450 | 476.0 - 493.0 | 450 | 16 | 16 | 6 | 1705,09 |
| 702000000136 | 450 | 487.3 - 504.3 | 450 | 10 | 16 | 6 | 1705,09 |
| 702000000140 | 450 | 487.3 - 504.3 | 450 | 16 | 16 | 6 | 1705,09 |
| 702000000141 | 450 | 501.9 - 518.9 | 450 | 10 | 16 | 6 | 1705,09 |
| 702000000142 | 450 | 501.9 - 518.9 | 450 | 16 | 16 | 6 | 1705,09 |
| 702000000143 | 450 | 510.0 - 527.0 | 500 | 10 | 16 | 6 | 1989,19 |
| 702000000155 | 450 | 510.0 - 527.0 | 500 | 16 | 16 | 6 | 1989,19 |
| 702000000156 | 450 | 501.9 - 518.9 | 500 | 10 | 16 | 6 | 1989,19 |



Aplicación



Válido para



MAXIDAPTOR - ADAPTADORES DE BRIDA

| Ref. | DN | Tolerancia (mm) | Brida | | Presión Máx. de Trabajo (bar) | | €/Ud. |
|--------------|-----|-----------------|-------|------------|-------------------------------|-----|---------|
| | | | DN | Taladro PN | Agua | Gas | |
| 702000000145 | 450 | 501.9 - 518.9 | 500 | 16 | 16 | 6 | |
| 702000000150 | 450 | 510.0 - 527.0 | 450 | 10 | 16 | 6 | |
| 702000000159 | 500 | 527.0 - 544.0 | 500 | 10 | 16 | 6 | 1989,19 |
| 702000000160 | 500 | 527.0 - 544.0 | 500 | 16 | 16 | 6 | 1989,19 |
| 702000000161 | 500 | 540.1 - 557.1 | 500 | 10 | 16 | 6 | 1989,19 |
| 702000000165 | 500 | 540.1 - 557.1 | 500 | 16 | 16 | 6 | 1989,19 |
| 702000000166 | 500 | 555.3 - 572.3 | 500 | 10 | 16 | 6 | 1989,19 |
| 702000000170 | 500 | 555.3 - 572.3 | 500 | 16 | 16 | 6 | 1989,19 |
| 702000000171 | 500 | 566.5 - 583.5 | 500 | 10 | 16 | 6 | 1989,19 |
| 702000000175 | 500 | 566.5 - 583.5 | 500 | 16 | 16 | 6 | 1989,19 |
| 702000000180 | 500 | 582.2 - 599.2 | 500 | 10 | 16 | 6 | 2101,85 |
| 702000000185 | 500 | 582.2 - 599.2 | 500 | 16 | 16 | 6 | 2279,97 |
| 702000000187 | 600 | 601.0 - 618.0 | 600 | 10 | 16 | 6 | 2364,00 |
| 702000000188 | 600 | 601.0 - 618.0 | 600 | 16 | 16 | 6 | 2364,00 |
| 702000000189 | 600 | 630.5 - 647.5 | 600 | 10 | 16 | 6 | 2364,00 |
| 702000000190 | 600 | 630.5 - 647.5 | 600 | 16 | 16 | 6 | 2364,00 |
| 702000000191 | 600 | 645.2 - 662.2 | 600 | 10 | 16 | 6 | 2364,00 |
| 702000000195 | 600 | 645.2 - 662.2 | 600 | 16 | 16 | 6 | 2364,00 |
| 702000000196 | 600 | 662.0 - 679.0 | 600 | 10 | 16 | 6 | 2364,00 |
| 702000000200 | 600 | 662.0 - 679.0 | 600 | 16 | 16 | 6 | 2364,00 |

* Precios con Junta de EPDM, para Nitrilo consultar



Aplicación



Válido para



ULTRAGRIP - UNIONES DE GRAN TOLERANCIA

| Ref. | DN | Tolerancia (mm) | Presión Máx. de Trabajo (bar) | | €/Ud.* |
|--------------|-----|-----------------|-------------------------------|-----|---------|
| | | | Agua | Gas | |
| 150050000010 | 40 | 043.5 - 063.5 | 16 | 4 | 322,03 |
| 150040000000 | 50 | 048.0 - 071.0 | 16 | 4 | 349,06 |
| 150065000020 | 65 | 063.0 - 083.7 | 16 | 4 | 376,24 |
| 150080000030 | 80 | 085.7 - 107.0 | 16 | 4 | 431,96 |
| 150100000040 | 100 | 107.2 - 133.2 | 16 | 4 | 508,16 |
| 150125000050 | 125 | 132.2 - 160.2 | 16 | 4 | 696,57 |
| 150150000060 | 150 | 158.2 - 192.2 | 16 | 4 | 867,33 |
| 150175000070 | 175 | 192.2 - 226.9 | 16 | 4 | 1189,67 |
| 150200000080 | 200 | 218.1 - 256.0 | 16 | 4 | 1291,94 |
| 150250000090 | 250 | 266.2 - 310.0 | 16 | 4 | 1663,24 |
| 150300000100 | 300 | 315.0 - 356.0 | 16 | 4 | 1977,26 |
| 150350000110 | 350 | 352.2 - 396.0 | 10 | 4 | 3335,74 |
| 150400000120 | 400 | 398.2 - 442.0 | 10 | 4 | 3591,02 |
| 150450000130 | 450 | 448.0 - 492.0 | 10 | ** | 5428,86 |
| 150500000140 | 500 | 498.0 - 552.0 | 10 | ** | 6540,68 |
| 150500000141 | 500 | 558.0 - 608.0 | 10 | ** | 7251,05 |
| 150600000150 | 600 | 604.0 - 648.0 | 10 | ** | 8062,78 |
| 150600000151 | 600 | 676.0 - 726.0 | 10 | ** | 8632,29 |
| 150700000160 | 700 | 700-735 | 16 | ** | |
| 150700000161 | 700 | 727-762 | 16 | ** | |
| 150700000162 | 700 | 750-785 | 16 | ** | |
| 150800000170 | 800 | 789 - 824 | 16 | ** | |
| 150800000171 | 800 | 825 - 860 | 16 | ** | |
| 150800000172 | 800 | 853 - 888 | 16 | ** | |

* Precios con Junta de EPDM, para Nitrilo consultar

** No apto para gas

Permite convertirla en no autoblocante.

Utiliza misma mordaza para todo tipo de materiales compatibles. Para aplicaciones en PE y PVC.

Material: Cuerpo de fundición revestido con Rilsan Nylon 11.

Revestimiento de tornillos: Capa de lubricante en seco.

Revestimiento de tuercas: Decromet.

Mordaza: Copolímero de Acetal.

Deflexión angular de hasta 8°.

Juntas: EPDM para Aplicaciones en Agua, Nitrilo para Aplicaciones en Gas.



Aplicación



Válido para



ULTRAGRIP - UNIONES REDUCIDAS DE GRAN TOLERANCIA

| Ref. | DN | Tolerancia (mm) | | Presión Máx. de Trabajo (bar) | | €/Ud.* |
|--------------|-----------|-----------------|---------------|-------------------------------|-----|---------|
| | | Extremo Peq. | Extremo Gran. | Agua | Gas | |
| 152032040000 | 032 / 040 | 036.0 - 046.0 | 043.5 - 063.5 | 16 | 4 | 401,00 |
| 152080100000 | 080 / 100 | 085.7 - 107.0 | 107.2 - 133.2 | 16 | 4 | 577,70 |
| 152100125000 | 100 / 125 | 107.2 - 133.2 | 132.2 - 160.2 | 16 | 4 | 663,50 |
| 152100150000 | 100 / 150 | 107.2 - 133.2 | 158.2 - 192.2 | 16 | 4 | 833,49 |
| 152125150000 | 125 / 150 | 132.2 - 160.2 | 158.2 - 192.2 | 16 | 4 | 865,90 |
| 152150175000 | 150 / 175 | 158.2 - 192.2 | 192.9 - 226.2 | 16 | 4 | 1130,62 |
| 152175200000 | 175 / 200 | 192.9 - 226.9 | 218.1 - 256.0 | 16 | 4 | 1425,33 |
| 152200250000 | 200 / 250 | 218.1 - 256.0 | 266.2 - 310.0 | 16 | 4 | 1673,49 |
| 152250300000 | 250 / 300 | 266.2 - 310.0 | 315.0 - 356.0 | 16 | 4 | 2046,37 |
| 152400450000 | 400 / 450 | 398.0 - 442.0 | 448.0 - 492.0 | 10 | ** | 4271,89 |
| 152500500000 | 500 / 500 | 498.0 - 552.0 | 558.0 - 608.0 | 10 | ** | 5378,39 |
| 152600000000 | 600 / 600 | 604.0 - 648.0 | 676.0 - 726.0 | 10 | ** | 7244,84 |

* Precios con Junta de EPDM, para Nitrilo consultar.

** No apto para gas

Permite convertirla en no autoblocante.

Utiliza misma mordaza para todo tipo de materiales compatibles. Para aplicaciones en PE y PVC.

Material: Cuerpo de fundición revestido con Rilsan Nylon 11.

Revestimiento de tornillos: Capa de lubricante en seco.

Revestimiento de tuercas: Decromet.

Mordaza: Copolímero de Acetal.

Deflexión angular de hasta 8°.

Juntas: EPDM para Aplicaciones en Agua, Nitrilo para Aplicaciones en Gas.



Aplicación



Válido para



ULTRAGRIP - ADAPTADORES DE BRIDAS DE GRAN TOLERANCIA

| Ref. | DN | Tolerancia (mm) | Brida | | Presión Máx. de Trabajo (bar) | | €/Ud.* |
|-------------|-----|-----------------|-------|------------|-------------------------------|-----|---------|
| | | | DN | Taladro PN | Agua | Gas | |
| 15105000010 | 40 | 043.5 - 063.5 | 50 | 10 / 16 | 16 | 4 | 277,57 |
| 15104000000 | 50 | 048.0 - 071.0 | 50 | 10 / 16 | 16 | 4 | 325,79 |
| 15106500020 | 65 | 063.0 - 083.7 | 65 | 10 / 16 | 16 | 4 | 338,97 |
| 15108000030 | 80 | 085.7 - 107.0 | 80 | 10 / 16 | 16 | 4 | 391,64 |
| 15110000040 | 100 | 107.2 - 133.2 | 100 | 10 / 16 | 16 | 4 | 484,47 |
| 15112500050 | 125 | 132.2 - 160.2 | 125 | 10 / 16 | 16 | 4 | 613,94 |
| 15115000060 | 150 | 158.2 - 192.2 | 150 | 10 / 16 | 16 | 4 | 734,01 |
| 15117500070 | 175 | 192.2 - 226.9 | 200 | 10 / 16 | 16 | 4 | 944,37 |
| 15120000080 | 200 | 218.1 - 256.0 | 200 | 10 / 16 | 16 | 4 | 1018,63 |
| 15125000090 | 250 | 266.2 - 310.0 | 250 | 10 / 16 | 16 | 4 | 1329,14 |
| 15130000100 | 300 | 315.0 - 356.0 | 300 | 10 / 16 | 16 | 4 | 1645,92 |
| 15135000110 | 350 | 352.2 - 396.0 | 350 | 10 / 16 | 10 | 4 | 2564,30 |
| 15140000120 | 400 | 398.2 - 442.0 | 400 | 10 / 16 | 10 | 4 | 2926,04 |
| 15140000121 | 450 | 448.0 - 492.0 | 400 | 10 / 16 | 10 | ** | 4426,26 |
| 15150000130 | 500 | 498.0 - 552.0 | 500 | 10 / 16 | 10 | ** | 5269,38 |
| 15150000131 | 500 | 558.0 - 608.0 | 500 | 10 / 16 | 10 | ** | 5659,72 |
| 15160000140 | 600 | 604.0 - 648.0 | 600 | 10 / 16 | 10 | ** | 6466,58 |
| 15160000141 | 600 | 676.0 - 726.0 | 600 | 10 / 16 | 10 | ** | 7356,93 |
| 15170000150 | 700 | 700-735 | 700 | 10 / 16 | 16 | ** | |
| 15170000151 | 700 | 727-762 | 700 | 10 / 16 | 16 | ** | |
| 15170000152 | 700 | 750-785 | 700 | 10 / 16 | 16 | ** | |
| 15180000160 | 800 | 789 - 824 | 800 | 10 / 16 | 16 | ** | |
| 15180000161 | 800 | 825 - 860 | 800 | 10 / 16 | 16 | ** | |
| 15180000162 | 800 | 853 - 888 | 800 | 10 / 16 | 16 | ** | |

* Precios con Junta de EPDM, para Nitrilo consultar.

** No apto para gas

Permite convertirla en no autoblocante.

Utiliza misma mordaza para todo tipo de materiales compatibles. Para aplicaciones en PE y PVC.

Material: Cuerpo de fundición revestido con Rilsan Nylon 11.

Revestimiento de tornillos: Capa de lubricante en seco.

Revestimiento de tuercas: Decromet.

Mordaza: Copolímero de Acetal.

Deflexión angular de hasta 8°.

Juntas: EPDM para Aplicaciones en Agua, Nitrilo para Aplicaciones en Gas.

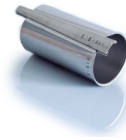

Aplicación



Válido para



ULTRAGRIP - CASQUILLOS ALINEADORES DE ACERO

SDR11

| Ref. | Ø | €/Ud. |
|--------------|-----|-------|
| 153040011100 | 40 | |
| 153050011100 | 50 | 35,89 |
| 153063011100 | 63 | |
| 153075011100 | 75 | |
| 153090011100 | 90 | |
| 153110011100 | 110 | |
| 153125011100 | 125 | |
| 153140011100 | 140 | |
| 153160011100 | 160 | |
| 153180011100 | 180 | |
| 153200011100 | 200 | |
| 153225011100 | 225 | |
| 153250011100 | 250 | |
| 153280011100 | 280 | |
| 153315011100 | 315 | |
| 153355011100 | 355 | |
| 153400011100 | 400 | |
| 153450011100 | 450 | |
| 153500011100 | 500 | |
| 153560011100 | 560 | |
| 153630011100 | 630 | |
| 156710011100 | 710 | |

SDR17

| Ref. | Ø | €/Ud. |
|--------------|-----|--------|
| 153063017100 | 63 | |
| 153075017100 | 75 | |
| 153090017100 | 90 | 115,91 |
| 153110017100 | 110 | 91,83 |
| 153125017100 | 125 | |
| 153140017100 | 140 | |
| 153160017100 | 160 | |
| 153180017100 | 180 | |
| 153200017100 | 200 | |
| 153225017100 | 225 | |
| 153250017100 | 250 | |
| 153280017100 | 280 | |
| 153315017100 | 315 | |
| 153355017100 | 355 | |
| 153400017100 | 400 | |
| 153450017100 | 450 | |
| 153500017100 | 500 | |
| 153560017100 | 560 | |
| 153630017100 | 630 | |
| 153710017100 | 710 | |

Para aplicaciones con PE y PVC es necesario el uso de casquillos alineadores en toda la gama ULTRAGRIP



Aplicación



Válido para



QUICKFIT - UNIONES

| Ref. | DN | Ø Tubo | Presión Máx. Trabajo (bar) | €/Ud.* |
|--------------|-----|---------------|----------------------------|--------|
| 720000040040 | 40 | 047.9 - 051.3 | 40 | 159,11 |
| 720000040050 | 50 | 059.5 - 063.3 | 40 | 203,51 |
| 720000040065 | 65 | 075.3 - 079.1 | 40 | 267,93 |
| 720000040080 | 80 | 088.1 - 091.9 | 40 | 292,02 |
| 721000040080 | 80 | 095.8 - 100.2 | 40 | 292,02 |
| 720000040100 | 100 | 107.2 - 111.0 | 40 | 353,78 |
| 721000040100 | 100 | 113.5 - 120.2 | 40 | 353,78 |
| 720000040125 | 125 | 138.9 - 142.7 | 40 | 453,81 |
| 720000025150 | 150 | 158.2 - 162.0 | 25 | 501,31 |
| 721000025150 | 150 | 167.5 - 172.3 | 25 | 501,31 |
| 720000025175 | 175 | 192.2 - 196.7 | 25 | 515,24 |
| 720000025200 | 200 | 218.3 - 224.4 | 25 | 587,83 |
| 720000025250 | 250 | 272.2 - 276.5 | 25 | 694,35 |
| 720000025300 | 300 | 323.1 - 328.6 | 25 | 848,33 |

* Precios con Junta de EPDM, para Nitrilo consultar.

Especialmente diseñados para grandes presiones (hasta 46 bar).

Material: Cuerpo de fundición revestido con Rilsan Nylon 11.

Revestimiento de tornillos y tuercas: Sheraplex.

Juntas: EPDM para Aplicaciones en Agua, Nitrilo para Aplicaciones en Gas.



Aplicación



Válido para



QUICKFIT - ADAPTADORES DE BRIDA

| Ref. | DN | Ø Tubo | Material | Brida | | €/Ud.* |
|--------------|-----|---------------|-------------------------|-------|-------------|---------|
| | | | | DN | Taladro PN | |
| 722000000050 | 50 | 059.5 - 063.3 | Acero/PVC /PVCu | 50 | 10/16/25/40 | 298,15 |
| 722000000065 | 65 | 075.3 - 079.1 | Acero | 65 | 10/16 | 387,03 |
| 722000000080 | 80 | 088.1 - 091.9 | Acero/PVC /PVCu | 80 | 10/16/25/40 | 446,05 |
| 723000000080 | 80 | 095.8 - 100.2 | Fund. Dúctil | 80 | 10/16/25/40 | 446,05 |
| 722000000100 | 100 | 107.2 - 111.0 | Acero/PVC | 100 | 10/16 | 474,55 |
| 723000000100 | 100 | 113.5 - 120.2 | Acero/PVCu/Fund. Dúctil | 100 | 10/16 | 474,55 |
| 722000000125 | 125 | 138.9 - 142.7 | Acero/PVC/PVCu | 125 | 10/16 | 531,22 |
| 722000000150 | 150 | 158.2 - 162.0 | Acero/PVC/PVCu | 150 | 10/16 | 605,14 |
| 723000000150 | 150 | 167.5 - 172.3 | Acero/Fund. Dúctil | 150 | 10/16 | 605,14 |
| 722000000200 | 200 | 192.2 - 196.7 | Acero/PVCu | 200 | 10/16 | 717,75 |
| 723000000200 | 200 | 218.3 - 224.4 | Acero/PVCu/Fund. Dúctil | 200 | 10/16 | 827,30 |
| 722000000250 | 250 | 272.2 - 276.5 | Acero/PVCu/Fund. Dúctil | 250 | 10/16 | 1091,52 |
| 722000000300 | 300 | 323.1 - 328.6 | Acero/PVCu/Fund. Dúctil | 300 | 10/16 | 1325,55 |

* Precios con Junta de EPDM, para Nitrilo consultar.

Especialmente diseñados para grandes presiones (hasta 46 bar).

Material: Cuerpo de fundición revestido con Rilsan Nylon 11.

Revestimiento de tornillos y tuercas: Sheraplex.

Juntas: EPDM para Aplicaciones en Agua, Nitrilo para Aplicaciones en Gas.



Aplicación



Válido para



CARRETES DE DESMONTAJE

| Ref. | DN | PN Brida | €/Ud.* |
|--------------|------|----------|----------|
| 17000050100 | 50 | 10 / 16 | 357,72 |
| 17000065100 | 65 | 10 / 16 | 372,53 |
| 17000080100 | 80 | 10 / 16 | 434,07 |
| 170000100100 | 100 | 10 / 16 | 478,14 |
| 170000125100 | 125 | 10 / 16 | 609,09 |
| 170000150100 | 150 | 10 / 16 | 716,14 |
| 170000200110 | 200 | 10 | 955,84 |
| 170000200116 | 200 | 16 | 1032,20 |
| 170000250110 | 250 | 10 | 1281,78 |
| 170000250116 | 250 | 16 | 1423,87 |
| 170000300110 | 300 | 10 | 1394,44 |
| 170000300116 | 300 | 16 | 1550,25 |
| 170000350110 | 350 | 10 | 1768,91 |
| 170000350116 | 350 | 16 | 1966,37 |
| 170000400110 | 400 | 10 | 2169,23 |
| 170000400116 | 400 | 16 | 2412,60 |
| 170000450110 | 450 | 10 | 2412,60 |
| 170000450116 | 450 | 16 | 2688,52 |
| 170000500110 | 500 | 10 | 2940,00 |
| 170000500116 | 500 | 16 | 3272,74 |
| 170000600110 | 600 | 10 | 3567,50 |
| 170000600116 | 600 | 16 | 3973,30 |
| 170000700110 | 700 | 10 | 4222,07 |
| 170000700116 | 700 | 16 | 4711,66 |
| 170000800110 | 800 | 10 | 5558,25 |
| 170000800116 | 800 | 16 | 6169,47 |
| 170000900110 | 900 | 10 | 6610,32 |
| 170000900116 | 900 | 16 | 7340,71 |
| 170001000110 | 1000 | 10 | 11775,23 |
| 170001000116 | 1000 | 16 | 13079,48 |
| 170001100110 | 1100 | 10 | 15821,34 |
| 170001100116 | 1100 | 16 | 20998,55 |
| 170001200110 | 1200 | 10 | 29797,87 |
| 170001200116 | 1200 | 16 | 35227,00 |
| 170001400110 | 1400 | 10 | 36747,13 |
| 170001400116 | 1400 | 16 | 39540,52 |
| 170001500110 | 1500 | 10 | 44139,52 |
| 170001500116 | 1500 | 16 | 47459,71 |
| 170001600110 | 1600 | 10 | 52166,22 |
| 170001600116 | 1600 | 16 | 56092,87 |
| 170001800110 | 1800 | 10 | 70201,82 |
| 170001800116 | 1800 | 16 | 75452,39 |
| 170002000110 | 2000 | 10 | 88365,77 |
| 170002000116 | 2000 | 16 | 95078,88 |

* Otras presiones consultar

Para válvulas, bombas y medidores.
Posibilidad de otras dimensiones y PN bajo petición.
Material: Acero revestido con Rilsan Nylon 11.



Aplicación



Válido para



HANDICLAMP - ABRAZADERAS SIMPLES DE REPARACIÓN EN ACERO INOXIDABLE

| DN | Tolerancia (mm) | Presión Máx. de Trabajo (bar) | | L-150 mm | | L-200 mm | |
|-----|-----------------|-------------------------------|-----|--------------|--------|--------------|--------|
| | | Agua | Gas | Ref. | €/Ud | Ref. | €/Ud |
| 32 | 044.0 - 048.0 | 24 | 6 | 706000000004 | 116,76 | 706000200004 | 100,94 |
| 32 | 048.0 - 052.0 | 24 | 6 | 706000000005 | 90,15 | 706000200005 | 101,83 |
| 40 | 054.0 - 058.0 | 24 | 6 | 706000000010 | 90,15 | 706000200010 | 101,83 |
| 40 | 058.0 - 064.0 | 24 | 6 | 706000000014 | 91,72 | 706000200014 | 106,52 |
| 50 | 060.0 - 067.0 | 24 | 6 | 706000000015 | 91,72 | 706000200015 | 106,52 |
| 50 | 063.0 - 070.0 | 24 | 6 | 706000000016 | 91,72 | 706000200016 | 106,52 |
| 50 | 068.0 - 076.0 | 24 | 6 | 706000000020 | 93,94 | 706000200020 | 108,73 |
| 65 | 075.0 - 083.0 | 24 | 6 | 706000000035 | 97,39 | 706000200035 | 112,83 |
| 65 | 082.0 - 089.0 | 20 | 5 | 706000000040 | 97,39 | 706000200040 | 112,83 |
| 80 | 087.0 - 096.0 | 20 | 5 | 706000000045 | 99,04 | 706000200045 | 113,88 |
| 80 | 095.0 - 105.0 | 20 | 5 | 706000000055 | 100,34 | 706000200055 | 115,00 |
| 90 | 102.0 - 112.0 | 20 | 5 | 706000150060 | 100,76 | 706000000060 | 128,99 |
| 100 | 113.0 - 123.0 | 20 | 5 | 706000150075 | 103,65 | 706000000075 | 132,24 |
| 100 | 120.0 - 130.0 | 16 | 4 | 706000150085 | 117,91 | 706000000085 | 135,77 |
| 125 | 132.0 - 142.0 | 16 | 4 | - | - | 706000000095 | 137,86 |
| 125 | 135.0 - 145.0 | 16 | 4 | - | - | 706000000100 | 137,86 |
| 125 | 147.0 - 157.0 | 16 | 4 | - | - | 706000000105 | 144,66 |
| 150 | 151.0 - 161.0 | 16 | 4 | - | - | 706000000110 | 145,84 |
| 150 | 160.0 - 170.0 | 16 | 4 | - | - | 706000000115 | 145,84 |
| 150 | 167.0 - 178.0 | 16 | 4 | - | - | 706000000125 | 148,52 |
| 150 | 176.0 - 187.0 | 16 | 4 | - | - | 706000000140 | 155,24 |
| 175 | 186.0 - 196.0 | 16 | 4 | - | - | 706000000150 | 165,06 |
| 175 | 193.0 - 203.0 | 16 | 4 | - | - | 706000000155 | 165,63 |
| 175 | 200.0 - 210.0 | 16 | 4 | - | - | 706000000160 | 165,63 |
| 200 | 215.0 - 225.0 | 16 | 4 | - | - | 706000000170 | 180,46 |
| 200 | 219.0 - 229.0 | 16 | 4 | - | - | 706000000175 | 180,46 |
| 225 | 230.0 - 240.0 | 10 | 2,5 | - | - | - | - |
| 225 | 237.0 - 247.0 | 10 | 2,5 | - | - | - | - |
| 225 | 240.0 - 250.0 | 10 | 2,5 | - | - | - | - |
| 225 | 250.0 - 260.0 | 10 | 2,5 | - | - | - | - |
| 225 | 257.0 - 267.0 | 10 | 2,5 | - | - | - | - |

También disponibles en L-300 mm y L-400 mm

| | | | | | | | |
|-----|---------------|----|-----|---|---|---|---|
| 225 | 261.0 - 271.0 | 10 | 2,5 | - | - | - | - |
| 250 | 270.0 - 280.0 | 10 | 2,5 | - | - | - | - |
| 250 | 280.0 - 291.0 | 6 | 1,5 | - | - | - | - |
| 250 | 290.0 - 300.0 | 6 | 1,5 | - | - | - | - |
| 300 | 300.0 - 310.0 | 6 | 1,5 | - | - | - | - |
| 300 | 310.0 - 320.0 | 6 | 1,5 | - | - | - | - |
| 300 | 315.0 - 325.0 | 6 | 1,5 | - | - | - | - |
| 300 | 320.0 - 330.0 | 6 | 1,5 | - | - | - | - |
| 300 | 330.0 - 340.0 | 6 | 1,5 | - | - | - | - |
| 300 | 340.0 - 350.0 | 6 | 1,5 | - | - | - | - |
| 300 | 350.0 - 360.0 | 6 | 1,5 | - | - | - | - |

También disponibles en L-300 mm y L-400 mm



Aplicación



Válido para



HANDICLAMP - ABRAZADERAS DOBLES DE REPARACIÓN EN ACERO INOXIDABLE

| DN | Tolerancia (mm) | Presión Máx. de Trabajo (bar) | | L-200 mm | | L-300 mm | |
|-----|-----------------|-------------------------------|-----|--------------|--------|--------------|--------|
| | | Agua | Gas | Ref. | €/Ud | Ref. | €/Ud |
| 80 | 088.0 - 110.0 | 20 | 5 | 706000000335 | 201,72 | 706000300335 | 298,77 |
| 100 | 108.0 - 128.0 | 20 | 5 | 706000000337 | 205,60 | 706000300337 | 326,32 |
| 100 | 113.0 - 133.0 | 20 | 5 | 706000000338 | 212,40 | 706000300338 | 318,22 |
| 100 | 120.0 - 140.0 | 20 | 5 | 706000000339 | 212,39 | 706000300339 | 312,12 |
| 125 | 130.0 - 150.0 | 16 | 4 | 706000000340 | 218,01 | 706000300340 | 318,04 |
| 125 | 140.0 - 160.0 | 16 | 4 | 706000000342 | 220,76 | 706000300342 | 327,00 |
| 150 | 150.0 - 170.0 | 16 | 4 | 706000000364 | 225,59 | 706000300364 | 335,81 |
| 150 | 159.0 - 180.0 | 16 | 4 | 706000000343 | 228,56 | 706000300343 | 339,41 |
| 150 | 168.0 - 189.0 | 16 | 4 | 706000000346 | 230,46 | 706000300346 | 343,43 |
| 150 | 170.0 - 190.0 | 16 | 4 | 706000000347 | 230,75 | 706000300347 | 342,48 |
| 150 | 175.0 - 195.0 | 16 | 4 | 706000000357 | 232,81 | 706000300357 | 344,28 |
| 175 | 190.0 - 210.0 | 16 | 4 | 706000000348 | 234,68 | 706000300348 | 389,36 |
| 200 | 205.0 - 225.0 | 16 | 4 | 706000000349 | 260,10 | 706000300349 | 346,47 |
| 200 | 210.0 - 230.0 | 16 | 4 | 706000000350 | 260,10 | 706000300350 | 353,29 |
| 200 | 216.0 - 238.0 | 16 | 4 | 706000000351 | 261,28 | 706000300351 | 357,32 |
| 200 | 220.0 - 242.0 | 10 | 2,5 | 706000000352 | 261,67 | 706000300352 | 360,76 |
| 225 | 240.0 - 260.0 | 10 | 2,5 | 706000000353 | 270,51 | 706000300353 | 388,22 |
| 225 | 243.0 - 263.0 | 10 | 2,5 | 706000000354 | 274,79 | 706000300354 | 396,78 |
| 225 | 255.0 - 275.0 | 10 | 2,5 | 706000200205 | 279,89 | 706000000205 | 394,46 |
| 250 | 272.0 - 292.0 | 10 | 2,5 | 706000200215 | 290,20 | 706000000215 | 391,03 |
| 250 | 282.0 - 302.0 | 6 | 1,5 | 706000200220 | 302,05 | 706000000220 | 470,08 |
| 250 | 295.0 - 315.0 | 6 | 1,5 | 706000200225 | 319,85 | 706000000225 | 393,53 |
| 300 | 307.0 - 327.0 | 6 | 1,5 | - | - | 706000000229 | 394,46 |
| 300 | 315.0 - 335.0 | 6 | 1,5 | - | - | 706000000230 | 428,50 |
| 300 | 319.0 - 339.0 | 6 | 1,5 | - | - | 706000000234 | 428,50 |
| 300 | 322.0 - 344.0 | 6 | 1,5 | - | - | 706000000235 | 449,63 |
| 300 | 333.0 - 353.0 | 6 | 1,5 | - | - | 706000000413 | 452,24 |
| 300 | 341.0 - 361.0 | 6 | 1,5 | - | - | 706000000362 | 478,75 |
| 350 | 365.0 - 385.0 | 5 | 1,3 | - | - | 706000000363 | 499,77 |

También disponibles en L-300 mm y L-400 mm



Aplicación



Válido para



HANDICLAMP - ABRAZADERAS TRIPLES DE REPARACIÓN EN ACERO INOXIDABLE (L-400)

| Ref. | Tolerancia | €/Ud.* |
|--------------|---------------|---------|
| 706000000240 | 340.0 - 370.0 | |
| 706000000423 | 385.0 - 415.0 | 747,30 |
| 706000000245 | 395.0 - 425.0 | 864,44 |
| 706000000250 | 440.0 - 470.0 | 888,32 |
| 706000000255 | 475.0 - 505.0 | 1432,79 |
| 706000000260 | 530.0 - 560.0 | 1719,35 |
| 706000000421 | 535.0 - 565.0 | 2736,28 |

Válvulas

Trampillones

Accesorios

Ventosas

Hidrantes y bocas de riego

Collarines, abrazaderas, tomas en carga

Bridas

Válvulas y accesorios de fundición

INFRAESTRUCTURA





Válvulas y accesorios de fundición

Válvulas de compuerta



* Para válvulas de cierre elástico
** ACS sólo para válvulas azules

NEXUS - VÁLVULAS DE COMPUERTA DE CIERRE ELÁSTICO CON BRIDAS CORTAS

Serie 14 - PN16

| Referencia | DN | PN | €/Ud. |
|------------|-----|-------|-----------|
| 10729010 | 50 | 10/16 | 139,88 |
| 10729015 | 65 | 10/16 | 174,66 |
| 10729020 | 80 | 10/16 | 181,95 |
| 10729025 | 100 | 10/16 | 225,50 |
| 10729030 | 125 | 10/16 | 330,61 |
| 10729035 | 150 | 10/16 | 369,21 |
| 10729040 | 200 | 10 | CONSULTAR |
| 10729045 | 200 | 16 | 630,65 |
| 10729050 | 250 | 10 | CONSULTAR |
| 10729055 | 250 | 16 | CONSULTAR |
| 10729060 | 300 | 10 | CONSULTAR |
| 10729065 | 300 | 16 | CONSULTAR |

Disponible en PN10 y PN16
Con eje en acero inoxidable AISI 316 L +10%
Juntas en EPDM
Bajo pedido juntas en NBR

También disponible en color rojo para saneamiento y aguas residuales.
PRECIOS CONSULTAR



* Para válvulas de cierre elástico
** ACS sólo para válvulas azules

NEXUS - VÁLVULAS DE COMPUERTA DE CIERRE ELÁSTICO CON BRIDAS LARGAS

Serie 15 - PN16

| Referencia | DN | PN | €/Ud. |
|------------|-----|-------|-----------|
| 10733010 | 50 | 10/16 | 158,24 |
| 10733015 | 65 | 10/16 | 180,02 |
| 10733020 | 80 | 10/16 | 202,95 |
| 10733025 | 100 | 10/16 | 246,16 |
| 10733030 | 125 | 10/16 | 370,76 |
| 10733035 | 150 | 10/16 | 436,10 |
| 10733040 | 200 | 10 | CONSULTAR |
| 10733045 | 200 | 16 | 720,49 |
| 10733050 | 250 | 10 | CONSULTAR |
| 10733055 | 250 | 16 | CONSULTAR |
| 10733060 | 300 | 10 | CONSULTAR |
| 10733065 | 300 | 16 | CONSULTAR |

Disponible en PN10 y PN16
Con eje en acero inoxidable AISI 316 L +10%
Juntas en EPDM
Bajo pedido juntas en NBR

También disponible en color rojo para saneamiento y aguas residuales.
PRECIOS CONSULTAR



* Para válvulas de cierre elástico
** ACS sólo para válvulas azules

MODELO 3000 - VÁLVULAS DE COMPUERTA DE CIERRE ELÁSTICO CON BRIDAS

Serie 14 - PN16

| Referencia | DN | €/Ud. |
|--------------|-----|--------|
| 666040000001 | 40 | 152,50 |
| 666050000001 | 50 | 152,50 |
| 666060000001 | 60 | 191,11 |
| 666065000001 | 65 | 191,11 |
| 666080000001 | 80 | 201,04 |
| 666100000001 | 100 | 245,00 |
| 666125000001 | 125 | 362,70 |
| 666150000001 | 150 | 405,14 |
| 666200000001 | 200 | 722,36 |



También disponible en color rojo para saneamiento y aguas residuales. **PRECIOS CONSULTAR**
Cierre izquierda disponible bajo pedido

| Referencia | DN | €/Ud. |
|--------------|-----|----------|
| 666250000001 | 250 | 1.100,76 |
| 666300000001 | 300 | 1.578,53 |
| 666350000001 | 350 | 3.783,88 |
| 666400000001 | 400 | 4.739,41 |
| 666450000001 | 450 | 7.911,74 |
| 666500000001 | 500 | 8.561,48 |

Disponible en PN10 y PN16
Con eje en acero inoxidable AISI 316 L +10%
Cierre izquierda disponible bajo pedido
Juntas en EPDM
Bajo pedido juntas en NBR



* Para válvulas de cierre elástico
** ACS sólo para válvulas azules

NEXUS BLOCKPLUS - VÁLVULAS DE COMPUERTA DE CIERRE ELÁSTICO CON EXTREMOS ANTITRACCIÓN PARA TUBOS DE PE/PVC

PN16

| Referencia | DN | DN ext. Tubo | €/Ud. |
|------------|-----|--------------|----------|
| 10720700 | 50 | 63 | 449,11 |
| 10720705 | 65 | 75 | 511,97 |
| 10720710 | 80 | 90 | 565,86 |
| 10720714 | 100 | 110 | 718,56 |
| 10720720 | 125 | 125 | 988,02 |
| 10720725 | 150 | 160 | 1.149,69 |
| 10720730 | 200 | 200 | 1.706,58 |

Con eje en acero inoxidable AISI 316 L +10%
Juntas en EPDM
Bajo pedido juntas en NBR



* Para válvulas de cierre elástico
** ACS sólo para válvulas azules

MODELO 3000 - VÁLVULAS DE COMPUERTA DE CIERRE ELÁSTICO CON BRIDAS

Serie 15 - PN25

| Referencia | DN | €/Ud. |
|--------------|-----|----------|
| 666040025001 | 40 | 317,23 |
| 666050025001 | 50 | 317,23 |
| 666060025001 | 60 | 359,27 |
| 666065025001 | 65 | 359,27 |
| 666080025001 | 80 | 428,08 |
| 666100025001 | 100 | 500,69 |
| 666125025001 | 125 | 722,36 |
| 666150025001 | 150 | 848,51 |
| 666200025001 | 200 | 1.230,71 |
| 666250025001 | 250 | 1.972,20 |
| 666300025001 | 300 | 2.870,39 |

Con eje en acero inoxidable AISI 316 L +10%
Cierre izquierda disponible bajo pedido
Juntas en EPDM
Bajo pedido juntas en NBR



* Para válvulas de cierre elástico
** ACS sólo para válvulas azules



También disponible en color rojo para saneamiento y aguas residuales. **PRECIOS CONSULTAR**
Cierre izquierda disponible bajo pedido

MODELO 3000 - VÁLVULAS DE COMPUERTA DE CIERRE ELÁSTICO CON BRIDAS

Serie 15 - PN16

| Referencia | DN | €/Ud. |
|--------------|-----|--------|
| 666040000002 | 40 | 173,89 |
| 666050000002 | 50 | 173,89 |
| 666060000002 | 60 | 198,75 |
| 666065000002 | 65 | 198,75 |
| 666080000002 | 80 | 223,58 |
| 666100000002 | 100 | 271,37 |
| 666125000002 | 125 | 408,96 |
| 666150000002 | 150 | 477,76 |
| 666200000002 | 200 | 795,00 |

| Referencia | DN | €/Ud. |
|--------------|-----|-----------|
| 666250000002 | 250 | 1.246,02 |
| 666300000002 | 300 | 2.048,64 |
| 666350000002 | 350 | 4.296,03 |
| 666400000002 | 400 | 4.968,72 |
| 666450000002 | 450 | 8.630,30 |
| 666500000002 | 500 | 9.306,79 |
| 666600000002 | 600 | 14.906,16 |

Disponible en PN10 y PN16
Con eje en acero inoxidable AISI 316 L +10%
Cierre izquierda disponible bajo pedido
Juntas en EPDM
Bajo pedido juntas en NBR

Válvulas y accesorios de fundición

Válvulas de compuerta / Válvulas de acometida



MODELO 3000 - VÁLVULAS DE COMPUERTA METÁLICA

PN40

| Referencia | DN | €/Ud. |
|--------------|-----|-----------|
| 666040040008 | 40 | 490,41 |
| 666050040008 | 50 | 556,85 |
| 666060040008 | 60 | 650,28 |
| 666065040008 | 65 | 650,28 |
| 666080040008 | 80 | 858,68 |
| 666100040008 | 100 | 1.185,62 |
| 666125040008 | 125 | 1.602,38 |
| 666150040008 | 150 | 2.073,01 |
| 666200040008 | 200 | 3.434,68 |
| 666250040008 | 250 | 5.205,92 |
| 666300040008 | 300 | 6.314,30 |
| 666350040008 | 350 | 11.365,72 |
| 666400040008 | 400 | 15.319,56 |
| 666450040008 | 450 | 16.817,74 |
| 666500040008 | 500 | 27.430,78 |
| 666600040008 | 600 | 32.889,99 |
| 666700040008 | 700 | 57.663,95 |



SÉCULO XXI - VÁLVULAS DE ACOMETIDA REGISTRO CON UNIONES ROSCADAS

PN10 - PN16

| Referencia | Ø x Rh | €/Ud. |
|--------------|-----------|--------|
| 666020025002 | 20 - ¾" | 75,30 |
| 666025032002 | 25 - 1" | 75,30 |
| 666032040002 | 32 - 1 ¼" | 113,50 |
| 666040050002 | 40 - 1 ½" | 113,50 |
| 666050063002 | 50 - 2" | 140,64 |

Con eje en acero inoxidable AISI 316 L +10%



SÉCULO XXI - VÁLVULAS DE ACOMETIDA REGISTRO CON UNIONES ROSCADAS

PN10 - PN16

| Referencia | Ø x Rh | €/Ud. |
|--------------|---------------|--------|
| 666025032003 | 25/ 1" - 1 ¼" | 152,71 |
| 666032040003 | 32/1 ¼" - 2" | 179,63 |
| 666040050003 | 40/ 1 ½" - 2" | 215,57 |
| 666050063003 | 50/ 2" - 2" | 269,46 |

Con eje en acero inoxidable AISI 316 L +10%



TRAMPILLONES MODELO TELESCÓPICO

| Referencia | Modelo | €/Ud. |
|------------|-----------------|-------|
| E139EBAREC | CUADRADO | 46,92 |
| E139EBARER | REDONDO | 46,92 |
| E139EBAREH | HEXAGONAL | 46,92 |
| E737CLEBAC | LLAVE DE CIERRE | 89,36 |

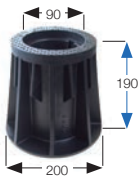

Un solo cuerpo



3 tapas diferentes = Reducción de stocks

TRAMPILLONES COMPOSITE

| Referencia | Modelo | €/Ud. |
|------------|-----------------|-------|
| E139EBA4ER | REDONDO | 25,46 |
| E139EBA4EC | CUADRADO | 25,46 |
| E139EBA4EE | HEXAGONAL | 25,46 |
| E737CLEBAC | LLAVE DE CIERRE | 89,36 |



CUADRADILLO

| Referencia | DN | €/Ud. |
|--------------|-----------------------------------|-------|
| 666020050027 | 20-¾"/25-1"/32 1 ¼"/40-1 ½"/50-2" | 16,17 |
| 666040050027 | 40-50 | 16,17 |
| 666060080027 | 60-65-80 | 16,17 |
| 666100150027 | 100-125-150 | 16,17 |
| 666200200027 | 200 | 19,77 |
| 666250300027 | 250-300 | 21,57 |
| 666350500027 | 350-400-450-500 | 41,31 |
| 666600600027 | 600 | 89,83 |



VOLANTE

| Referencia | DN | €/Ud. |
|--------------|-----------------------------------|--------|
| 666020050008 | 20-¾"/25-1"/32 1 ¼"/40-1 ½"/50-2" | 19,12 |
| 666040050006 | 40-50 | 19,12 |
| 666065080006 | 60-65-80 | 21,00 |
| 666100100006 | 100 | 21,00 |
| 666125150006 | 125-150 | 38,21 |
| 666200200006 | 200 | 76,45 |
| 666250250006 | 250 | 107,03 |
| 666300300006 | 300 | 126,11 |
| 666350400006 | 350-400 | 152,89 |
| 666450500006 | 450-500 | 191,11 |
| 666600600006 | 600 | 267,53 |



OBTURADOR ANTIRROBO

| Referencia | DN | €/Ud. |
|------------|--------------------------------------|-----------|
| 10720101 | 20-¼" / 25-1" /32-1 ¼"/40-1 ½"/50-2" | 89,82 |
| | Otros DN | CONSULTAR |



LLAVE PARA OBTURADOR ANTIRROBO

| Referencia | DN | €/Ud. |
|------------|--------------------------------------|-----------|
| 10720100 | 20-¼" / 25-1" /32-1 ¼"/40-1 ½"/50-2" | 574,84 |
| | Otros DN | CONSULTAR |



EJE TELESCÓPICO 1 METRO

| Referencia | DN | €/Ud. |
|--------------|----------------|--------|
| 666020050013 | 20-25-32-40-50 | 79,11 |
| 666040050013 | 40 - 50 | 79,11 |
| 666060080013 | 60-65-80 | 79,11 |
| 666100100013 | 100 | 79,11 |
| 666125150013 | 125-150 | 79,11 |
| 666200200013 | 200 | 79,11 |
| 666250300013 | 250-300 | 105,11 |
| 666350350013 | 350 | 105,11 |
| 666400400013 | 400 | 147,53 |
| 666450500013 | 450/500 | 147,93 |
| 666350500013 | 350 HASTA 500 | 147,93 |
| 666600600013 | 600 | 154,81 |



LLAVE DE M

| Referencia | €/Ud. |
|------------|--------|
| 10701005 | 179,63 |

JLAS



VÁLVULAS DE MARIPOSA MODELO DUPLEX 500

Serie 14 - PN10

| Referencia | DN | €/Ud. |
|--------------|------|-----------|
| 66615000012 | 150 | 1.770,63 |
| 666200010012 | 200 | 1.897,45 |
| 666250010012 | 250 | 2.176,75 |
| 666300010012 | 300 | 2.507,44 |
| 666350010012 | 350 | 3.340,59 |
| 666400010012 | 400 | 3.846,26 |
| 666450010012 | 450 | 5.514,13 |
| 666500010012 | 500 | 6.072,78 |
| 666600010012 | 600 | 7.671,63 |
| 666700010012 | 700 | 11.403,91 |
| 666800010012 | 800 | 15.831,29 |
| 666900010012 | 900 | 22.803,01 |
| 666100010012 | 1000 | 27.323,47 |
| 666110010012 | 1100 | 41.282,99 |

Serie 14 - PN16

| Referencia | DN | €/Ud. |
|--------------|------|-----------|
| 66615000012 | 150 | 1.770,63 |
| 666200016012 | 200 | 1.897,45 |
| 666250016012 | 250 | 2.176,75 |
| 666300016012 | 300 | 2.507,44 |
| 666350016012 | 350 | 3.340,59 |
| 666400016012 | 400 | 3.846,26 |
| 666450016012 | 450 | 5.514,13 |
| 666500016012 | 500 | 6.072,78 |
| 666600016012 | 600 | 9.204,70 |
| 666700016012 | 700 | 11.683,52 |
| 666800016012 | 800 | 16.304,84 |
| 666900016012 | 900 | 23.486,86 |
| 666100016012 | 1000 | 28.143,76 |
| 666110016012 | 1100 | 42.522,25 |

Con eje en acero inoxidable AISI 316 L +10%

Serie 14 - PN25

| Referencia | DN | €/Ud. |
|--------------|------|-----------|
| 666150025012 | 150 | 2.167,13 |
| 666200025012 | 200 | 2.321,25 |
| 666250025012 | 250 | 2.661,53 |
| 666300025012 | 300 | 3.066,09 |
| 666350025012 | 350 | 4.085,42 |
| 666400025012 | 400 | 4.703,47 |
| 666450025012 | 450 | 6.745,37 |
| 666500025012 | 500 | 7.427,62 |
| 666600025012 | 600 | 11.259,45 |
| 666700025012 | 700 | 19.130,13 |
| 666800025012 | 800 | 23.238,04 |
| 666900025012 | 900 | 29.289,95 |
| 666100025012 | 1000 | 38.285,91 |
| 666110025012 | 1100 | CONSULTAR |



VÁLVULAS DE COMPUERTA DE CIERRE ELÁSTICO MODELO 3000 PARA GAS

Serie 14 - PN10-16

| Referencia | Ø | €/Ud. |
|--------------|-----|----------|
| 666063G10020 | 63 | 808,37 |
| 666075G10020 | 75 | 898,18 |
| 666090G10020 | 90 | 1.077,83 |
| 666110G10020 | 110 | 1.257,48 |
| 666125G10020 | 125 | 1.616,75 |
| 666160G10020 | 160 | 2.065,85 |
| 666200G10020 | 200 | 3.592,76 |
| 666250G10020 | 250 | 4.311,32 |
| 666315G10020 | 315 | 8.981,92 |

Con extremos de PE SDR11-SDR17



VÁLVULAS DE RETENCIÓN DE CLAPETA
SERIE 48 - PN 16

| Referencia | DN | €/Ud. |
|--------------|-----|-----------|
| 666050000028 | 50 | 344,00 |
| 666060000028 | 60 | 429,99 |
| 666065000028 | 65 | 429,99 |
| 666080000028 | 80 | 481,60 |
| 666100000028 | 100 | 584,78 |
| 666125000028 | 125 | 872,03 |
| 666150000028 | 150 | 1.289,95 |
| 666200000028 | 200 | 1.931,51 |
| 666250000028 | 250 | 3.439,90 |
| 666300000028 | 300 | 4.299,85 |
| 666350000028 | 350 | 5.159,83 |
| 666400000028 | 400 | 7.223,76 |
| 666450000028 | 450 | 10.319,65 |
| 666500000028 | 500 | 13.415,55 |
| 666600000028 | 600 | 19.435,35 |

Con eje y asiento en acero inoxidable AISI 316 L +30%



VÁLVULAS DE RETENCIÓN DE CLAPETA CON CONTRAPESO

SERIE 48 - PN 16

| Referencia | DN | €/Ud. |
|--------------|-----|-----------|
| 666050016028 | 50 | 412,78 |
| 666060016028 | 60 | 515,99 |
| 666065016028 | 65 | 515,99 |
| 666080016028 | 80 | 584,78 |
| 666100016028 | 100 | 687,99 |
| 666125016028 | 125 | 1.031,96 |
| 666150016028 | 150 | 1.547,96 |
| 666200016028 | 200 | 2.321,92 |
| 666250016028 | 250 | 4.127,88 |
| 666300016028 | 300 | 5.159,83 |
| 666350016028 | 350 | 6.019,79 |
| 666400016028 | 400 | 8.599,72 |
| 666450016028 | 450 | 12.039,60 |
| 666500016028 | 500 | 14.619,51 |
| 666600016028 | 600 | 20.639,33 |

Con eje en acero inoxidable 316 L +30%
También disponible en color rojo para saneamiento y aguas residuales. **PRECIOS CONSULTAR**



FILTRO
PN16

| Referencia | DN | €/Ud. |
|--------------|-----|----------|
| 666040000032 | 40 | 235,33 |
| 666050000032 | 50 | 267,67 |
| 666060000032 | 60 | 362,87 |
| 666065000032 | 65 | 362,87 |
| 666080000032 | 80 | 393,41 |
| 666100000032 | 100 | 571,25 |
| 666125000032 | 125 | 704,19 |
| 666150000032 | 150 | 937,71 |
| 666200000032 | 200 | 1.564,63 |
| 666250000032 | 250 | 2.319,14 |
| 666300000032 | 300 | 3.111,34 |

También disponible en PN10 y PN25



VÁLVULAS DE RETENCIÓN DE BOLA
PN 16

| Referencia | Ø x Rh | €/Ud. |
|--------------|---------|--------|
| 666032001630 | 32-1 ¼" | 125,55 |
| 666040001630 | 40-1 ½" | 125,55 |
| 666050001630 | 50-2" | 151,36 |

Disponible también en PN10
También disponible en color rojo para saneamiento y aguas residuales. **PRECIOS CONSULTAR**



VÁLVULAS DE RETENCIÓN DE BOLA

PN 16

| Referencia | DN | €/Ud. |
|--------------|-----|----------|
| 666040016031 | 40 | 180,60 |
| 666050016031 | 50 | 180,60 |
| 666060016031 | 60 | 223,58 |
| 666065016031 | 65 | 223,58 |
| 666080016031 | 80 | 266,59 |
| 666100016031 | 100 | 378,40 |
| 666125016031 | 125 | 567,58 |
| 666150016031 | 150 | 705,18 |
| 666200016031 | 200 | 1.152,37 |
| 666250016031 | 250 | 2.476,73 |
| 666300016031 | 300 | 3.405,48 |
| 666350016031 | 350 | 5.331,84 |
| 666400016031 | 400 | 8.444,91 |

Disponible también en PN10

También disponible en color rojo para saneamiento y aguas residuales. **PRECIOS CONSULTAR**

HERRAMIENTA PARA EXTRACCIÓN DE BOLA

| Referencia | DN | €/Ud. |
|------------|---------|----------|
| 10763744 | 32-1 ¼" | 215,57 |
| 10763744 | 40-1 ½" | 215,57 |
| 10763754 | 50-2" | 215,57 |
| 10763744 | 40 | 215,57 |
| 10763754 | 50 | 215,57 |
| 10763764 | 60 | 359,27 |
| 10763764 | 65 | 359,27 |
| 10763784 | 80 | 359,27 |
| 10763794 | 100 | 413,17 |
| 10763804 | 125 | 413,17 |
| 10763814 | 150 | 467,06 |
| 10763824 | 200 | 556,85 |
| 10763834 | 250 | 682,62 |
| 10763844 | 300 | 898,18 |
| 10763854 | 350 | 1.257,48 |
| 10763864 | 400 | 1.616,75 |



BOLA DE RECAMBIO

| Referencia | DN | €/Ud. |
|------------------------------|----------|----------|
| BOLA DE RECAMBIO DE ALUMINIO | 32 / 1¼" | 64,52 |
| BOLA DE RECAMBIO DE ALUMINIO | 40 / 1½" | 64,52 |
| BOLA DE RECAMBIO DE ALUMINIO | 50 / 2" | 64,52 |
| BOLA DE RECAMBIO DE ALUMINIO | 40 | 64,52 |
| BOLA DE RECAMBIO DE ALUMINIO | 50 | 64,52 |
| BOLA DE RECAMBIO DE ALUMINIO | 60 | 69,78 |
| BOLA DE RECAMBIO DE ALUMINIO | 65 | 69,78 |
| BOLA DE RECAMBIO DE ALUMINIO | 80 | 81,97 |
| BOLA DE RECAMBIO DE ALUMINIO | 100 | 123,84 |
| BOLA DE RECAMBIO DE HIERRO | 125 | 176,15 |
| BOLA DE RECAMBIO DE HIERRO | 150 | 211,03 |
| BOLA DE RECAMBIO DE HIERRO | 200 | 385,42 |
| BOLA DE RECAMBIO DE HIERRO | 250 | 776,11 |
| BOLA DE RECAMBIO DE HIERRO | 300 | 1.130,14 |
| BOLA DE RECAMBIO DE HIERRO | 350 | 1.574,89 |
| BOLA DE RECAMBIO DE HIERRO | 400 | 2.799,23 |



VENTOSAS AUTOMÁTICAS DE DOBLE EFECTO

PN 16

| Referencia | DN | €/Ud. |
|--------------|-------------|--------|
| 666040065011 | 40-50-60-65 | 325,16 |
| 666080002111 | 80 | 384,42 |
| 666100002111 | 100 | 384,42 |
| 666025002111 | 1" | 282,02 |
| 666032002111 | 1 ¼" | 282,02 |

| Referencia | DN | €/Ud. |
|--------------|------|--------|
| 666040000111 | 1 ½" | 282,02 |
| 666200002111 | 2" | 282,02 |
| 666212002111 | 2 ½" | 296,40 |

Opcional con filtro. Consultar.



VENTOSAS AUTOMÁTICAS DE TRIPLE EFECTO SIN VÁLVULA PARA AGUAS LIMPIAS

PN 10

| Referencia | DN | €/Ud. |
|------------|-----|----------|
| 19908610 | 50 | 731,12 |
| 19908615 | 60 | 731,12 |
| 19908620 | 65 | 731,12 |
| 19908630 | 80 | 860,46 |
| 19908640 | 100 | 860,46 |
| 19908650 | 150 | 2.204,16 |
| 19908660 | 200 | 3.533,50 |

PN 16

| Referencia | DN | €/Ud. |
|------------|-----|----------|
| 19908610 | 50 | 731,12 |
| 19908615 | 60 | 731,12 |
| 19908620 | 65 | 731,12 |
| 19908630 | 80 | 860,46 |
| 19908640 | 100 | 860,46 |
| 19908650 | 150 | 2.204,16 |
| 19908661 | 200 | 3.533,50 |



VENTOSAS AUTOMÁTICAS DE TRIPLE EFECTO CON VÁLVULA PARA AGUAS LIMPIAS

PN 10

| Referencia | DN | €/Ud. |
|--------------|-----|----------|
| 666050003005 | 50 | 1.007,78 |
| 666060003005 | 60 | 1.007,78 |
| 666065003005 | 65 | 1.007,78 |
| 666080003005 | 80 | 1.230,52 |
| 666100003005 | 100 | 1.230,52 |
| 666150003005 | 150 | 2.759,25 |
| 666200013005 | 200 | 4.458,63 |

PN 16

| Referencia | DN | €/Ud. |
|--------------|-----|----------|
| 666050003005 | 50 | 1.007,78 |
| 666060003005 | 60 | 1.007,78 |
| 666065003005 | 65 | 1.007,78 |
| 666080003005 | 80 | 1.230,52 |
| 666100003005 | 100 | 1.230,52 |
| 666150003005 | 150 | 2.759,25 |
| 666200003005 | 200 | 4.458,63 |

PATROL
X-380



| Medida | Ref. | U/ | n.º | € |
|--------|---------------|----|------|--------------|
| ¾" BSP | 093108 | 10 | A-10 | 18,95 |
| 1" BSP | 093109 | 10 | A-10 | 18,95 |

Ventosa doble efecto, cierre a baja presión.

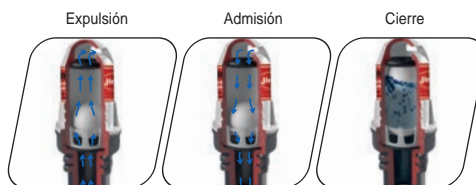

X-380 - Ventosa de Vacío/ Cierre a baja presión.

Expulsión: En el momento de llenado de la red, la ventosa permanece abierta expulsando todo el aire sobrante de la instalación, hasta que la red está llena de agua y la ventosa cierra de manera estanca.

Admisión: Bajo presiones negativas (vacío), la ventosa abre introduciendo aire en la red, evitando de esta forma deterioros en tuberías y accesorios.

Cierre: En el momento en que el agua toma contacto con el flotador, lo empuja hasta su cierre estanco con la junta torica.

X-294



| Medida | Ref. | U/ | n.º | € |
|----------|----------------|----|------|--------------|
| ¾" BSP | 093067 | 10 | A-10 | 19,86 |
| 1" BSP | 093068 | 10 | A-10 | 19,86 |
| 1 ½" BSP | 093082 | 4 | A-2 | 43,56 |
| 2" BSP | 093083 | 4 | A-2 | 43,56 |
| 1 ½" BSP | 193082* | 4 | A-2 | 45,74 |
| 2" BSP | 193083* | 4 | A-2 | 45,74 |

Ventosa doble efecto.

* Con filtro de toma.

X-295



| Medida | Ref. | U/ | n.º | € |
|----------|----------------|----|------|---------------|
| ¾" BSP | 093071 | 10 | A-10 | 38,99 |
| 1" BSP | 093072 | 10 | A-10 | 38,99 |
| 1 ½" BSP | 093086 | 1 | A-1 | 124,10 |
| 2" BSP | 093087 | 1 | A-1 | 124,10 |
| 1 ½" BSP | 193086* | 1 | A-1 | 130,50 |
| 2" BSP | 193087* | 1 | A-1 | 130,50 |

Ventosa triple efecto.

* Con cuna filtro.

| Medida | Ref. | U/ | n.º | € |
|---------|---------------|----|------|-------------|
| 1 ½"-2" | 093116 | 10 | A-10 | 6,20 |

Cuna filtro ventosa.



HIDRANTE DE SUPERFICIE COLUMNA SECA

| Referencia | DN | PN | €/Ud. |
|--------------|-----|------------|----------|
| 666045070036 | 100 | 2x45-1x70 | 1.719,94 |
| 666070100036 | 100 | 2x70-1x100 | 1.719,94 |



HIDRANTES DE ACERA

| Referencia | DN | Salidas DN | Con Arqueta | €/Ud. |
|--------------|-----|------------|-------------|--------|
| 666080070034 | 80 | BARNA 70 | SI | 649,77 |
| 666080070035 | 80 | BARNA 70 | NO | 489,23 |
| 666100100034 | 100 | 100 | SI | 783,53 |
| 666100100035 | 100 | 100 | NO | 623,01 |



BOCA DE RIEGO

| Referencia | DN | Salidas DN | €/Ud. |
|--------------|-------------|-------------------------------|--------|
| 666040065014 | 40-50-60-65 | Rosca 1 1/2" Racord Barcelona | 428,08 |



COLLARÍN DE TOMA PARA PVC Y PE
PN10 - PN16 - PN25

| Referencia | Ø x Rh | €/Ud. |
|--------------|----------|--------|
| 666050034004 | 50 ¾" | 30,57 |
| 666050100004 | 50 1" | 30,57 |
| 666050114004 | 50 1 ¼" | 30,57 |
| 666050112004 | 50 1 ½" | 30,57 |
| 666063034004 | 63 ¾" | 33,64 |
| 666063100004 | 63 1" | 33,64 |
| 666063114004 | 63 1 ¼" | 33,64 |
| 666063112004 | 63 1 ½" | 33,64 |
| 666063200004 | 63 2" | 33,64 |
| 666075034004 | 75 ¾" | 38,21 |
| 666075100004 | 75 1" | 38,21 |
| 666075114004 | 75 1 ¼" | 38,21 |
| 666075112004 | 75 1 ½" | 38,21 |
| 666075200004 | 75 2" | 38,21 |
| 666090034004 | 90 ¾" | 44,32 |
| 666090100004 | 90 1" | 44,32 |
| 666090114004 | 90 1 ¼" | 44,32 |
| 666090112004 | 90 1 ½" | 44,32 |
| 666090200004 | 90 2" | 44,32 |
| 666090212004 | 90 2 ½" | 53,52 |
| 666110034004 | 110 ¾" | 53,52 |
| 666110100004 | 110 1" | 53,52 |
| 666110114004 | 110 1 ¼" | 53,52 |
| 666110112004 | 110 1 ½" | 53,52 |
| 666110200004 | 110 2" | 53,52 |
| 666110212004 | 110 2 ½" | 64,22 |
| 666110300004 | 110 3" | 68,79 |
| 666125034004 | 125 ¾" | 82,56 |
| 666125100004 | 125 1" | 82,56 |
| 666125114004 | 125 1 ¼" | 82,56 |
| 666125112004 | 125 1 ½" | 82,56 |
| 666125200004 | 125 2" | 82,56 |
| 666125212004 | 125 2 ½" | 99,37 |
| 666125300004 | 125 3" | 107,03 |
| 666140034004 | 140 ¾" | 82,56 |
| 666140100004 | 140 1" | 82,56 |
| 666140114004 | 140 1 ¼" | 82,56 |
| 666140112004 | 140 1 ½" | 82,56 |
| 666140200004 | 140 2" | 82,56 |
| 666140212004 | 140 2 ½" | 99,37 |
| 666140300004 | 140 3" | 107,03 |
| 666160034004 | 160 ¾" | 85,61 |
| 666160100004 | 160 1" | 85,61 |

| Referencia | Ø x Rh | €/Ud. |
|--------------|----------|--------|
| 666160114004 | 160 1 ¼" | 85,61 |
| 666160112004 | 160 1 ½" | 85,61 |
| 666160200004 | 160 2" | 85,61 |
| 666160212004 | 160 2 ½" | 100,92 |
| 666160300004 | 160 3" | 110,08 |
| 666180034004 | 180 ¾" | 122,30 |
| 666180100004 | 180 1" | 122,30 |
| 666180114004 | 180 1 ¼" | 122,30 |
| 666180112004 | 180 1 ½" | 122,30 |
| 666180200004 | 180 2" | 122,30 |
| 666200034004 | 200 ¾" | 122,30 |
| 666200100004 | 200 1" | 122,30 |
| 666200114004 | 200 1 ¼" | 122,30 |
| 666200112004 | 200 1 ½" | 122,30 |
| 666200200004 | 200 2" | 122,30 |
| 666200212004 | 200 2 ½" | 152,89 |
| 666200300004 | 200 3" | 165,13 |
| 666225034004 | 225 ¾" | 152,85 |
| 666225100004 | 225 1" | 152,85 |
| 666225114004 | 225 1 ¼" | 152,85 |
| 666225112004 | 225 1 ½" | 152,85 |
| 666225200004 | 225 2" | 152,85 |
| 666225212004 | 225 2 ½" | 182,43 |
| 666225300004 | 225 3" | 182,43 |
| 666250034004 | 250 ¾" | 152,85 |
| 666250100004 | 250 1" | 152,85 |
| 666250114004 | 250 1 ¼" | 152,85 |
| 666250112004 | 250 1 ½" | 152,85 |
| 666250200004 | 250 2" | 152,85 |
| 666250212004 | 250 2 ½" | 198,84 |
| 666250300004 | 250 3" | 198,84 |
| 666280034004 | 280 ¾" | 177,49 |
| 666280100004 | 280 1" | 177,49 |
| 666280114004 | 280 1 ¼" | 177,49 |
| 666280112004 | 280 1 ½" | 177,49 |
| 666280200004 | 280 2" | 177,49 |
| 666280212004 | 280 2 ½" | 210,38 |
| 666280300004 | 280 3" | 210,38 |
| 666315034004 | 315 ¾" | 182,43 |
| 666315100004 | 315 1" | 182,43 |
| 666315114004 | 315 1 ¼" | 182,43 |
| 666315112004 | 315 1 ½" | 182,43 |
| 666315200004 | 315 2" | 182,43 |
| 666315212004 | 315 2 ½" | 182,43 |
| 666315300004 | 315 3" | 216,94 |
| 666400034004 | 400 ¾" | 221,87 |
| 666400100004 | 400 1" | 221,87 |
| 666400114004 | 400 1 ¼" | 221,87 |
| 666400112004 | 400 1 ½" | 221,87 |
| 666400200004 | 400 2" | 221,87 |
| 666400212004 | 400 2 ½" | 262,97 |
| 666400300004 | 400 3" | 282,67 |



ADAPTADOR DE TOMA EN CARGA

PN 10 - PN 16

| Referencia | Rm x Rh | €/Ud. |
|--------------|-----------|--------|
| 666212000000 | 2" 1/2" | 179,64 |
| 666234000000 | 2" 3/4" | 179,64 |
| 666210000000 | 2" 1" | 179,64 |
| 666211400000 | 2" 1 1/4" | 179,64 |
| 666211200000 | 2" 1 1/2" | 179,64 |
| 666220000000 | 2" 2" | 179,64 |



LAMINA DE CORTE

| Referencia | €/Ud. |
|--------------|-------|
| 666LAM000000 | 89,82 |



BRIDAS DE UNIÓN DE DOBLE CÁMARA PARA TUBO DE PVC

| Referencia | DN/DN Tubo | PN | €/Ud. |
|--------------|-------------|-------|----------|
| 666063000000 | 50-63 | 10/16 | 30,97 |
| 666050065000 | 50-60-65/63 | 10/16 | 30,97 |
| 666065000000 | 60-65/63 | 10/16 | 30,97 |
| 666075000000 | 60-65/75 | 10/16 | 32,66 |
| 666090000000 | 80/90 | 10/16 | 39,55 |
| 666100000000 | 100/90 | 10/16 | 44,72 |
| 666110000000 | 100/110 | 10/16 | 44,72 |
| 666125000000 | 125/125 | 10/16 | 53,33 |
| 666140000000 | 125/140 | 10/16 | 58,46 |
| 666160000000 | 150/160 | 10/16 | 80,83 |
| 666200000000 | 200/200 | 10/16 | 96,31 |
| 666225000000 | 200/225 | 10/16 | 201,25 |
| 666250000000 | 250/250 | 10/16 | 180,60 |
| 666280000000 | 250/280 | 10/16 | 330,23 |
| 666315000000 | 300/315 | 10/16 | 330,23 |
| 666400010000 | 400/400 | 10 | 662,18 |
| 666400000000 | 400/400 | 16 | 662,18 |
| 666500010000 | 500/500 | 10 | 1.023,37 |
| 666500000000 | 500/500 | 16 | 1.023,37 |

También disponible en color rojo para saneamiento y aguas residuales. **PRECIOS CONSULTAR**



También disponible en color rojo para saneamiento y aguas residuales. **PRECIOS CONSULTAR**

BRIDAS DE UNIÓN DE DOBLE CÁMARA CON ANILLO AUTOBLOCANTE PARA PVC Y PE

| Referencia | DN/DN Tubo | PN | €/Ud. |
|--------------|------------|-------|----------|
| 666063000003 | 50/63 | 10/16 | 51,60 |
| 666065000003 | 60-65/63 | 10/16 | 56,75 |
| 666075000003 | 60-65/75 | 10/16 | 61,90 |
| 666090000003 | 80/90 | 10/16 | 70,52 |
| 666100000003 | 100/90 | 10/16 | 77,40 |
| 666110000003 | 100/110 | 10/16 | 77,40 |
| 666125000003 | 125/125 | 10/16 | 108,36 |
| 666140000003 | 125/140 | 10/16 | 113,50 |
| 666160000003 | 150/160 | 10/16 | 144,47 |
| 666200000003 | 200/200 | 10/16 | 185,76 |
| 666225000003 | 200/225 | 10/16 | 481,60 |
| 666250000003 | 250/250 | 10/16 | 423,09 |
| 666280000003 | 250/280 | 10/16 | 791,19 |
| 666315000003 | 300/315 | 10/16 | 589,93 |
| 666400010003 | 400/400 | 10 | 1.147,19 |
| 666400000003 | 400/400 | 16 | 1.147,19 |
| 666500010003 | 500/500 | 10 | 1.761,22 |
| 666500000003 | 500/500 | 16 | 1.761,22 |

| Referencia | DN/DN Tubo | PN | €/Ud. |
|--------------|------------|----|-----------|
| 666063025003 | 50/63 | 25 | 63,64 |
| 666065025003 | 60-65/63 | 25 | 70,52 |
| 666075025003 | 60-65/75 | 25 | 79,11 |
| 666090025003 | 80/90 | 25 | 87,71 |
| 666100025003 | 100/90 | 25 | 98,03 |
| 666110025003 | 100/110 | 25 | 98,03 |
| 666125025003 | 125/125 | 25 | 132,43 |
| 666140025003 | 125/140 | 25 | 142,74 |
| 666160025003 | 150/160 | 25 | 180,60 |
| 666200025003 | 200/200 | 25 | 232,19 |
| 666225025003 | 200/225 | 25 | 605,42 |
| 666250025003 | 250/250 | 25 | 531,47 |
| 666280025003 | 250/280 | 25 | CONSULTAR |
| 666315025003 | 300/315 | 25 | 741,29 |
| 666400025003 | 400/400 | 25 | 1.499,79 |
| 666500025003 | 500/500 | 25 | 2.289,25 |



CINTAS DE SEÑALIZACIÓN

| Referencia | Descripción | €/rollo |
|------------------------------|------------------------------------|---------|
| Rollo: A=15 cm, L=500 | | |
| CSA000500015 | ¡ATENCIÓN! Tubería de Agua Potable | 128,75 |
| CSG000500015 | Canalización de Gas | 128,75 |
| CST000500015 | Servicios de Telecomunicaciones | 128,75 |

REDI

Accesorios para saneamiento enterrado PVC

INFRAESTRUCTURA





Accesorios para saneamiento enterrado PVC

Color Gris / Cór Cinza: Ral 7037 • Color Teja / Cór Telha: Ral 8023

CON JUNTA / COM JUNTA FACETADA



45°

| Medida | Ref. | U/ | U/Pallet | € |
|--------|--------------------|----|----------|-----------------|
| 110 | SN8 030115E | 15 | 120 | 15,96 |
| 125 | 080125E | 10 | 80 | 19,48 |
| 160 | 030165E | 4 | 32 | 43,41 |
| 200 | 0302051 | 1 | 20 | 104,91 |
| 250 | 0302591 | 1 | 12 | 294,39 |
| 315 | 1303091 | 1 | 5 | 707,07 |
| 400 | o N304091 | 1 | 2 | 870,47 |
| 500 | *o N305091 | 1 | 1 | 1.592,89 |
| 630 | *o N306391 | 1 | 1 | 2.833,85 |

Derivación 45° macho/hembra, **con junta labiada**. Color Teja.
Forquilha 45° macho/fêmea, com o-ring labial. Cór Telha.



45°

| Medida | Ref. | U/ | U/Pallet | € |
|--------|----------------|----|----------|---------------|
| 110 | 044115E | 12 | 96 | 16,52 |
| 160 | 0441641 | 4 | 32 | 51,45 |
| 200 | 1442041 | 1 | 20 | 161,57 |
| 315 | 1443041 | 1 | 4 | 810,07 |

Derivación 45° hembra/hembra, **con junta labiada**. Color Teja.
Forquilha 45° fêmea/fêmea, com o-ring labial. Cór Telha.



45°

| Medida | Ref. | U/ | U/Pallet | € |
|---------|-------------------|----|----------|-----------------|
| 125-110 | 031925E | 10 | 80 | 14,00 |
| 160-110 | 031165E | 7 | 56 | 46,14 |
| 160-125 | 031365E | 6 | 48 | 52,66 |
| 200-110 | 031355E | 4 | 32 | 96,15 |
| 200-125 | 031375E | 4 | 32 | 101,88 |
| 200-160 | 031205E | 3 | 24 | 104,16 |
| 250-110 | o 0313391 | 1 | 20 | 287,58 |
| 250-125 | o D313491 | 1 | 16 | 287,58 |
| 250-160 | o 0314091 | 1 | 20 | 304,72 |
| 250-200 | o 0314191 | 1 | 14 | 309,42 |
| 315-110 | o 1318051 | 1 | 10 | 573,66 |
| 315-125 | o 1318151 | 1 | 9 | 573,66 |
| 315-160 | o 0314291 | 1 | 12 | 684,10 |
| 315-200 | o 0314391 | 1 | 10 | 716,04 |
| 315-250 | o D314491 | 1 | 5 | 797,93 |
| 400-110 | o 1314451 | 1 | 4 | 878,47 |
| 400-160 | o 1316651 | 1 | 4 | 958,71 |
| 400-200 | o 1317751 | 1 | 4 | 982,96 |
| 400-250 | o D314691 | 1 | 3 | 1.057,71 |
| 400-315 | o D314791 | 1 | 3 | 1.057,71 |
| 500-110 | *o 1315051 | 1 | 2 | 899,35 |
| 500-160 | *o 1315351 | 1 | 2 | 1.509,36 |
| 500-200 | *o 1315451 | 1 | 2 | 1.509,36 |
| 500-250 | *o D314991 | 1 | 3 | 1.743,78 |
| 500-315 | *o D315091 | 1 | 1 | 1.743,78 |
| 500-400 | *o D315191 | 1 | 1 | 1.872,26 |

Derivación 45° macho/hembra, reducida al centro, **con junta labiada**. Color Teja.

Forquilha 45° macho/fêmea, redução ao centro, com o-ring labial. Cór Telha.



45°

| Medida | Ref. | U/ | U/Pallet | € |
|----------------|--------------------|----|----------|---------------|
| 160-110 | 0311741 | 6 | 48 | 57,42 |
| 160-125 | + 0311832 | 6 | 48 | 59,15 |
| 200-125 | + 0313832 | 4 | 32 | 107,03 |
| 200-160 | 0312151 | 1 | 25 | 111,42 |
| 250-160 | 1444041 | 1 | 16 | 322,15 |
| 315-110 | 1443451 | 1 | 10 | 573,66 |
| 315-125 | o+ 1443542 | 1 | 10 | 573,66 |
| 315-250 | * 1444551 | 1 | 6 | 836,39 |
| 400-110 | *o 1444441 | 1 | 5 | 878,47 |
| 400-160 | o+ 1446642 | 1 | 5 | 878,47 |
| 400-200 | *o+ 1447742 | 1 | 4 | 878,47 |

Derivación 45° hembra/hembra, reducida al centro, **con junta labiada**. Color Teja.

Forquilha 45° fêmea/fêmea, redução ao centro, com o-ring labial. Cór Telha.



87°-30'

| Medida | Ref. | U/ | U/Pallet | € |
|--------|--------------------|----|----------|----------|
| 110 | SN8 034115E | 20 | 160 | 13,55 |
| 125 | 081125E | 12 | 96 | 16,45 |
| 160 | 081165E | 5 | 40 | 40,83 |
| 200 | 081205E | 1 | 30 | 87,57 |
| 250 | 0342591 | 1 | 18 | 243,39 |
| 315 | 1343091 | 1 | 8 | 579,50 |
| 400 | *o 1344051 | 1 | 2 | 870,47 |
| 500 | *o N345091 | 1 | 1 | 1.980,47 |
| 630 | *o N346391 | 1 | 1 | 2.964,75 |

Derivación 87° - 30' macho/hembra, con junta labiada. Color Teja.
Forquilha 87° - 30' macho/fêmea, com o-ring labial. Côr Telha.



87°-30'

| Medida | Ref. | U/ | U/Pallet | € |
|--------|-----------|----|----------|----------|
| 160 | 0451641 | 5 | 40 | 42,85 |
| 200 | 1452041 | 1 | 28 | 151,20 |
| 315 | 1453041 | 1 | 6 | 675,74 |
| 400 | o 1454051 | 1 | 2 | 1.169,21 |

Derivación 87°-30', hembra/hembra, con junta labiada. Color Teja.
Forquilha 87°-30', fêmea/fêmea, com o-ring labial. Côr Telha.



87°-30'

| Medida | Ref. | U/ | U/Pallet | € |
|---------|-------------|----|----------|--------|
| 160-110 | 0351741 | 8 | 64 | 52,79 |
| 200-110 | 0460141 | 1 | 33 | 138,25 |
| 200-160 | * 0460641 | 1 | 30 | 139,63 |
| 250-125 | * 1461241 | 1 | 18 | 287,99 |
| 250-160 | * 1461641 | 1 | 18 | 323,27 |
| 315-125 | 1464341 | 1 | 10 | 384,84 |
| 315-160 | 1464251 | 1 | 10 | 384,84 |
| 315-200 | *o 1464451 | 1 | 10 | 392,50 |
| 400-110 | *o 1465541 | 1 | 5 | 568,65 |
| 400-125 | *o 1463341 | 1 | 9 | 568,65 |
| 400-160 | 1466641 | 1 | 5 | 663,32 |
| 400-200 | o*+ 1467741 | 1 | 4 | 637,84 |
| 400-250 | o*+ 1468842 | 1 | 4 | 722,65 |
| 400-315 | 1469942 | 1 | 3 | 748,98 |

Derivación 87°-30', hembra/hembra, reducida al centro, con junta labiada. Color Teja.
Forquilha 87°-30', fêmea/fêmea, redução ao centro, com o-ring labial. Côr Telha.



87°-30'

| Medida | Ref. | U/ | U/Pallet | € |
|---------|-------------|----|----------|----------|
| 125-110 | 0357251 | 12 | 96 | 38,36 |
| 160-110 | 035165E | 10 | 80 | 47,00 |
| 160-125 | 0353651 | 1 | 70 | 48,96 |
| 200-110 | 035015E | 4 | 32 | 78,56 |
| 200-125 | 035025E | 4 | 32 | 67,22 |
| 200-160 | o 035205E | 4 | 32 | 72,62 |
| 250-110 | o 0353551 | 1 | 20 | 139,63 |
| 250-125 | 0353451 | 1 | 18 | 153,03 |
| 250-160 | o 0354051 | 1 | 18 | 233,13 |
| 250-200 | o 0353851 | 1 | 18 | 255,28 |
| 315-110 | o 1352251 | 1 | 10 | 384,84 |
| 315-125 | o 1353351 | 1 | 10 | 384,84 |
| 315-160 | o 1354451 | 1 | 12 | 373,70 |
| 315-200 | o 1355551 | 1 | 12 | 384,84 |
| 315-250 | o D354691 | 1 | 6 | 598,20 |
| 400-110 | *o 1354151 | 1 | 5 | 568,65 |
| 400-125 | *o+ 1354252 | 1 | 5 | 568,65 |
| 400-160 | o 1356651 | 1 | 4 | 597,57 |
| 400-200 | o 1357751 | 1 | 4 | 625,31 |
| 400-250 | o 1358851 | 1 | 4 | 663,32 |
| 400-315 | o 1359951 | 1 | 4 | 681,28 |
| 500-110 | *o 1355051 | 1 | 2 | 907,38 |
| 500-125 | *o 1355251 | 1 | 2 | 912,78 |
| 500-200 | *o 1355451 | 1 | 2 | 1.119,52 |
| 500-250 | *o D354991 | 1 | 3 | 1.778,55 |
| 500-315 | *o D355091 | 1 | 2 | 2.238,51 |
| 500-400 | *o D355191 | 1 | 1 | 2.406,83 |

Derivación 87°-30', macho/hembra, reducida al centro, con junta labiada. Color Teja.

Forquilha 87°-30', macho/fêmea, redução ao centro, com o-ring labial. Côr Telha.

SN8: Rigidez anular. / Rigidez anular.

o : Producto manipulado. / Produto manipulado.

+ : Color gris. / Côr Cinza.

* : Bajo pedido. / Sob pedido.



87°-30'

| Medida | Ref. | U/ | U/Pallet | € |
|--------|---------|----|----------|--------|
| 250 | 1402591 | 1 | 16 | 265,04 |
| 315 | 1403091 | 1 | 8 | 642,61 |

Te macho/hembra 87°-30' con boca de registro, con junta labiada.
Color Teja.

Forquilha macho/fêmea 87°-30' com boca de registro, com o-ring labial.
Côr Telha.



| Medida | Ref. | U/ | U/Pallet | € |
|--------|---------|----|----------|----------|
| 110 | 061115E | 45 | 360 | 7,66 |
| 125 | 061125E | 30 | 240 | 11,16 |
| 160 | 061165E | 18 | 144 | 24,37 |
| 200 | 061205E | 8 | 64 | 47,68 |
| 250 | 0612591 | 1 | 36 | 132,62 |
| 315 | 0613091 | 1 | 20 | 212,21 |
| 400 | 0614091 | 1 | 12 | 339,58 |
| 500 | 1615051 | 1 | 4 | 738,26 |
| 630 | D616391 | 1 | 3 | 2.279,41 |

Manguito dilatación hembra-hembra, con junta labiada.
Color Teja. SIN tope.

União dilatação fêmea-fêmea, com o-ring labial. Côr Telha.
SEM topo.



| Medida | Ref. | U/ | U/Pallet | € |
|--------|---------|----|----------|--------|
| 110 | 063115E | 45 | 360 | 9,60 |
| 125 | 063125E | 30 | 240 | 12,10 |
| 160 | 063165E | 18 | 144 | 24,37 |
| 200 | 063205E | 8 | 64 | 47,68 |
| 250 | 0632591 | 1 | 36 | 132,62 |
| 315 | 0633091 | 1 | 20 | 212,21 |
| 400 | 0634091 | 1 | 12 | 339,58 |
| 500 | 1635051 | 1 | 4 | 738,26 |

Manguito dilatación hembra-hembra, con junta labiada.
Color Teja. CON tope.

União dilatação fêmea-fêmea, com o-ring labial. Côr Telha.
COM topo.



| Ángulo - Medida | Ref. | U/ | U/Pallet | € |
|-----------------|---------|----|----------|----------|
| 15° 110 SN8 | 010115E | 40 | 320 | 5,43 |
| 15° 125 | 010125E | 25 | 200 | 9,30 |
| 15° 160 | 010165E | 13 | 104 | 18,46 |
| 15° 200 | 010205E | 8 | 64 | 38,64 |
| 15° 250 | 0102591 | 1 | 36 | 103,71 |
| 15° 315 | 0103091 | 1 | 18 | 163,32 |
| 15° 400 | 1104091 | 1 | 10 | 492,54 |
| 15° 500 *o | N105091 | 1 | 2 | 841,73 |
| 15° 630 *o | N106391 | 1 | 1 | 1.595,58 |
| 30° 110 SN8 | 011115E | 40 | 320 | 5,02 |
| 30° 125 | 011125E | 25 | 200 | 9,02 |
| 30° 160 | 011165E | 13 | 104 | 21,45 |
| 30° 200 | 011205E | 1 | 60 | 42,85 |
| 30° 250 | 0112591 | 1 | 33 | 114,82 |
| 30° 315 | 0113091 | 1 | 18 | 180,84 |
| 30° 400 | 1114091 | 1 | 8 | 553,22 |
| 30° 500 *o | N115091 | 1 | 2 | 1.102,61 |
| 30° 630 *o | N116391 | 1 | 1 | 1.595,58 |
| 45° 110 SN8 | 012115E | 35 | 280 | 6,97 |
| 45° 125 | 070125E | 23 | 184 | 8,36 |
| 45° 160 | 070165E | 10 | 80 | 22,79 |
| 45° 200 | 070205E | 5 | 40 | 53,22 |
| 45° 250 | 0122591 | 1 | 27 | 141,42 |
| 45° 315 | 0123091 | 1 | 14 | 204,71 |
| 45° 400 | 1124091 | 1 | 7 | 611,93 |
| 45° 500 | 1125091 | 1 | 4 | 914,46 |
| 45° 630 *o | N126391 | 1 | 1 | 1.595,58 |
| 67°-30' 110 SN8 | 013115E | 30 | 240 | 6,77 |
| 67°-30' 125 | 013125E | 20 | 160 | 11,20 |
| 67°-30' 160 | 013165E | 10 | 80 | 25,86 |
| 67°-30' 200 | 013205E | 5 | 40 | 56,43 |
| 87°-30' 110 SN8 | 071115E | 25 | 200 | 8,42 |
| 87°-30' 125 | 071125E | 20 | 160 | 13,94 |
| 87°-30' 160 | 071165E | 10 | 80 | 24,95 |
| 87°-30' 200 | 071205E | 1 | 40 | 56,75 |
| 87°-30' 250 | 0142591 | 1 | 20 | 177,32 |
| 87°-30' 315 | 0143091 | 1 | 10 | 294,98 |
| 87°-30' 400 | 1144091 | 1 | 6 | 817,83 |
| 87°-30' 500 *o | N145091 | 1 | 2 | 1.831,01 |
| 87°-30' 630 *o | N146391 | 1 | 1 | 2.041,96 |

Codo macho/hembra, con junta labiada. Color Teja
Curva macho/fêmea, com o-ring labial. Côr Telha.



| Ángulo - Medida | Ref. | U/ | U/Pallet | € |
|-----------------|---------|----|----------|--------|
| 45° 110 | 023115E | 30 | 240 | 18,77 |
| 45° 125 + | 0231242 | 20 | 160 | 21,40 |
| 45° 160 | 0231641 | 10 | 80 | 32,22 |
| 45° 200 | 0232041 | 5 | 40 | 63,84 |
| 45° 250 | 1232541 | 1 | 27 | 190,39 |
| 45° 315 | 1233041 | 1 | 12 | 275,64 |
| 45° 400 | 1234051 | 1 | 6 | 698,52 |
| 87°-30' 110 | 024135E | 25 | 200 | 19,17 |
| 87°-30' 125 + | 0241242 | 18 | 144 | 21,40 |
| 87°-30' 160 | 0241641 | 8 | 64 | 35,79 |
| 87°-30' 200 | 0242141 | 4 | 32 | 76,38 |
| 87°-30' 250 | 1242541 | 1 | 20 | 238,71 |
| 87°-30' 315 | 1243041 | 1 | 10 | 397,08 |
| 87°-30' 400 | 1244051 | 1 | 5 | 951,58 |

Codo hembra/hembra, con junta labiada. Color Teja
 Curva fêmea/fêmea, com o-ring labial. Cór Telha.



| Medida H / M | Ref. | U/ | U/Pallet | € |
|--------------|---------|----|----------|--------|
| A 110-125 | 051325E | 35 | 280 | 8,12 |
| A 110-160 | 051165E | 30 | 240 | 12,87 |
| B 110-200 o | 1533551 | 15 | 120 | 59,50 |
| B 110-250 | 0534151 | 10 | 80 | 90,96 |
| A 125-160 | 051365E | 30 | 240 | 12,87 |
| A 125-200 | 051205E | 15 | 120 | 32,18 |
| B 125-250 | 0534251 | 10 | 80 | 168,22 |
| A 160-200 | 051405E | 15 | 120 | 44,51 |
| A 160-250 | 0514651 | 1 | 85 | 56,13 |
| B 160-315 | 0534851 | 5 | 40 | 63,32 |
| A 200-250 | 051255E | 5 | 60 | 74,29 |
| A 200-315 | 051335E | 4 | 32 | 103,56 |
| B 200-400 o | 1536551 | 1 | 26 | 262,45 |
| A 250-315 | 0513091 | 1 | 32 | 119,80 |
| B 250-400 | 1537091 | 1 | 24 | 358,91 |
| A 315-400 | 0519291 | 1 | 18 | 272,47 |
| C 400-500 o | D519491 | 1 | 4 | 707,25 |

Ampliación excéntrica hembra-macho, con junta labiada. Color Teja.
 Ampliação excêntrica fêmez-macho, com o-ring labial. Cór Telha.
 H = Hembra-fêmea - M = Macho-macho.

SN8 : Rigidez anular. / Rigidez anular.

* : Consultar plazo de entrega. / Consultar prazo de entrega.

o : Producto manipulado. / Produto manipulado.

+ : Color gris. / Cór Cinza.



| Medida | Ref. | U/ | U/Pallet | € |
|--------|---------|-----|----------|--------|
| 110 | 066110E | 150 | 1200 | 4,21 |
| 125 | 066120E | 100 | 800 | 5,34 |
| 160 | 066160E | 55 | 440 | 11,82 |
| 200 | 066200E | 25 | 200 | 19,45 |
| 250 | 0662501 | 1 | 114 | 61,78 |
| 315 | 0663001 | 1 | 67 | 115,11 |
| 400 | 06640M1 | 1 | 50 | 175,59 |
| 500 | D665001 | 1 | 18 | 597,70 |

Tapón macho ciego para encolar. Color Teja.
 Tampão macho cego. Cór Telha.



| Medida | Ref. | U/ | U/Pallet | € |
|--------|---------|----|----------|--------|
| 110 | 0651101 | 70 | 560 | 8,97 |
| 125 | 0651201 | 50 | 400 | 11,23 |
| 160 | 1651601 | 30 | 240 | 19,13 |
| 200 | 1652001 | 15 | 120 | 32,18 |
| 250 | 1652501 | 10 | 100 | 83,37 |
| 315 | 1653001 | 5 | 50 | 122,46 |

Tapón macho con registro, para encolar. Color Teja.
 Tampão macho com registro, para colar. Cór Telha.



| Medida | Ref. | U/ | U/Pallet | € |
|--------|---------|----|----------|--------|
| 110 | 06613F1 | 30 | 1560 | 2,63 |
| 125 | 06615F1 | 20 | 1040 | 2,82 |
| 160 | 06617F1 | 30 | 720 | 9,72 |
| 200 | 06621F1 | 60 | 480 | 12,60 |
| 250 | 06628F1 | 30 | 240 | 27,40 |
| 315 | 06634F1 | 15 | 120 | 45,67 |
| 400 | 06640F1 | 1 | 50 | 140,53 |

Tapón hembra para encolar. Color Teja.
 Tampão fêmea. Cór Telha.



S-197

| Medida | Ref. | U/ | n.º | € |
|--------|--------|----|------|-------|
| 250 | 027004 | 12 | A-61 | 40,98 |
| 315 | 027028 | 4 | A-4 | 74,55 |

Tapón base, para encolar. Color Teja.
 Tampão base, para colar. Cór Telha.



90°

| Medida | Ref. | U/ | U/Pallet | € |
|---------|---------|----|----------|-------|
| 200-160 | 0434351 | 10 | 80 | 35,34 |
| 250-160 | 1424251 | 8 | 64 | 46,04 |
| 315-160 | 142525E | 8 | 64 | 81,85 |

Toma injerto 90°, con junta labiada. Color Teja.

Forquilha 90°, com o-ring labial. Cór Telha.



45°

| Medida | Ref. | U/ | U/Pallet | € |
|---------|---------|----|----------|--------|
| 160-125 | 0438091 | 15 | 120 | 29,46 |
| 200-125 | 0438291 | 10 | 80 | 32,95 |
| 200-160 | 0438491 | 10 | 60 | 42,55 |
| 250-125 | 0438691 | 10 | 70 | 43,58 |
| 250-160 | 0438891 | 6 | 48 | 56,67 |
| 315-125 | 1439091 | 5 | 40 | 69,50 |
| 315-160 | 0439491 | 5 | 30 | 84,21 |
| 400-125 | 1439191 | 5 | 40 | 83,66 |
| 400-160 | 1439591 | 3 | 24 | 96,82 |
| 400-200 | D434291 | 1 | 1 | 94,00 |
| 500-125 | 1439291 | 5 | 100 | 94,74 |
| 500-160 | 1439691 | 3 | 24 | 136,69 |

Toma injerto 45°, con junta labiada. Color Teja.

Forquilha 45°, com o-ring labial. Cór Telha.



| Medida | Ref. | U/ | U/Pallet | € |
|---------|---------|----|----------|--------|
| 136-110 | 0621191 | 30 | 240 | 26,49 |
| 160-125 | 0621291 | 18 | 144 | 39,94 |
| 190-160 | 0621691 | 10 | 80 | 63,05 |
| 242-200 | 0622091 | 1 | 60 | 144,75 |

Enlace mixto gres-PVC. Color Teja (unión a PVC, Macho Encolar).

União mista granito-PVC. Cór Telha (união PVC, Macho colar).



| Medida | Ref. | U/ | U/Pallet | € |
|--------|---------|----|----------|-------|
| 110 | 0641191 | 10 | 520 | 19,19 |
| 125 | 0641291 | 18 | 432 | 20,70 |
| 160 | 0641642 | 12 | 168 | 36,60 |
| 200 | 0642042 | 12 | 96 | 70,72 |

Manguito pasamuros, Superficie granulada, para mejor agarrar al cemento.

União passamuros. Superfície granulada, para melhor aderência do cimento.



Tubería de PVC-U presión



0802

Tubería PVC-U

INDUSTRIA



Más información



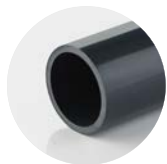

INDUSTRIA

Tubería de PVC-U presión

Tubería de PVC-U presión



UN EN 1452-2
PN 6 - 10 - 12,5 - 16 - 20
ø 16 ÷ 500 mm



NF EN 1452
PN 6 - 10 - 16 - 25
ø 16 ÷ 315 mm



DN-8061 - 62
Reihe 4, Reihe 5
PN 10 - 16



CARACTERÍSTICAS PRINCIPALES DE LAS TUBERÍAS DE PVC-U

Gama

PN 6 : desde d.63 hasta d400 mm
PN 10 : desde d 63 hasta d 315 mm
PN16 : desde d 20 hasta d.225 mm

La tubería cumple con la norma EN ISO 1452 para el transporte de fluidos bajo presión (agua potable, riego y aguas residuales). Tiene la marca de calidad IIP conforme a D.M. 174 DD. (agua para consumo humano), y según norma EN 1622, análisis de agua, determinación del umbral de olor (TON) y sabor (TFN).

Requisitos higiénicos

Los tubos Lareter U-PVC para conductos de presión cumplen requisitos higiénicos según el "Ministerio de Salud italiano" D.M.21.03.1973 y D.M. 174/2004.

Francia: certificación A.C.S.

(Atestación de Conformité Sanitaire)

Gran Bretaña: aprobado por WRAS (Water Regulations Advisory Scheme) producto.

Alemania: potabilidad publicada por Hygiene-Institut en nombre de DVGW

PN6

| Ø | Ref. | Espesor | Longitud (m) | Tubos/pallet | m (pallet completo) | € |
|-----|------------|---------|--------------|--------------|---------------------|--------|
| 63 | PIPEV33063 | 2 | 5 | 123 | 615 | 6,82 |
| 75 | PIPEV33075 | 2,2 | 5 | 87 | 435 | 9,47 |
| 90 | PIPEV33090 | 2,8 | 5 | 96 | 480 | 13,14 |
| 110 | PIPEV41110 | 2,7 | 5 | 57 | 285 | 15,63 |
| 125 | PIPEV41125 | 3,1 | 5 | 51 | 255 | 20,47 |
| 140 | PIPEV41140 | 3,5 | 5 | 45 | 225 | 25,61 |
| 160 | PIPEV41160 | 4 | 5 | 33 | 165 | 33,17 |
| 200 | PIPEV41200 | 4,9 | 5 | 20 | 100 | 50,86 |
| 225 | PIPEV41225 | 5,5 | 5 | 18 | 90 | 64,29 |
| 250 | PIPEV41250 | 6,2 | 5 | 12 | 60 | 80,64 |
| 280 | PIPEV41280 | 6,9 | 5 | 11 | 55 | 100,16 |
| 315 | PIPEV41315 | 7,7 | 5 | 9 | 45 | 126,06 |
| 400 | PIPEV41400 | 9,8 | 5 | 5 | 25 | 211,98 |

PN10

| | | | | | | |
|-----|------------|------|---|-----|-----|--------|
| 63 | PIPEV21063 | 3 | 5 | 123 | 615 | 9,26 |
| 75 | PIPEV21075 | 3,6 | 5 | 87 | 435 | 12,97 |
| 90 | PIPEV21090 | 4,3 | 5 | 96 | 480 | 18,65 |
| 110 | PIPEV26110 | 4,2 | 5 | 57 | 285 | 22,53 |
| 125 | PIPEV26125 | 4,8 | 5 | 51 | 255 | 29,00 |
| 140 | PIPEV26140 | 5,4 | 5 | 45 | 225 | 37,09 |
| 160 | PIPEV26160 | 6,2 | 5 | 33 | 165 | 48,24 |
| 180 | PIPEV26180 | 6,9 | 5 | 28 | 140 | 64,47 |
| 200 | PIPEV26200 | 7,7 | 5 | 20 | 100 | 74,91 |
| 225 | PIPEV26225 | 8,6 | 5 | 18 | 90 | 94,07 |
| 250 | PIPEV26250 | 9,6 | 5 | 12 | 60 | 116,49 |
| 280 | PIPEV26280 | 10,7 | 5 | 11 | 55 | 145,05 |
| 315 | PIPEV26315 | 12,1 | 5 | 9 | 45 | 185,12 |

PN16

| | | | | | | |
|-----|------------|------|---|------|------|--------|
| 20 | PIPEV13020 | 1,5 | 5 | 1166 | 5830 | 2,42 |
| 25 | PIPEV13025 | 1,9 | 5 | 757 | 3785 | 3,74 |
| 32 | PIPEV13032 | 2,4 | 5 | 449 | 2245 | 4,30 |
| 40 | PIPEV13040 | 3 | 5 | 275 | 1375 | 5,60 |
| 50 | PIPEV13050 | 3,7 | 5 | 194 | 970 | 8,64 |
| 63 | PIPEV13063 | 4,7 | 5 | 123 | 615 | 13,74 |
| 75 | PIPEV13075 | 5,6 | 5 | 87 | 435 | 19,44 |
| 90 | PIPEV13090 | 6,7 | 5 | 96 | 480 | 27,87 |
| 110 | PIPEV17110 | 6,6 | 5 | 57 | 285 | 34,20 |
| 125 | PIPEV17125 | 7,4 | 5 | 51 | 255 | 43,59 |
| 140 | PIPEV17140 | 8,3 | 5 | 45 | 225 | 55,30 |
| 160 | PIPEV17160 | 9,5 | 5 | 33 | 165 | 72,12 |
| 180 | PIPEV17180 | 10,7 | 5 | 28 | 140 | 91,18 |
| 200 | PIPEV17200 | 11,9 | 5 | 20 | 100 | 112,48 |
| 225 | PIPEV17225 | 13,4 | 5 | 20 | 100 | 142,59 |

Tubería PVC-U extremo plano.

Accesorios encolados, mixtos y roscados

Bridas y adaptadores

Uniones 3 piezas

Soportes y abrazaderas

Adhesivos y disolventes



0801

Accesorios de PVC-U presión

INDUSTRIA



Roscas

Perfectas, bien inyectadas y con exactitud milimétrica, ayudan a una perfecta unión suave y fiable con profesionalidad y calidad.



Nervios de tope

Permiten que el tubo sólo penetre hasta el tope.
El pegamento sobrante en su interior se escurre por dentro de la pieza sin cerrar el diámetro interior.

Lineas cada 45°

Ayudan en el montaje para encarar perfectamente los codos y las tes. Con ellas podemos hacer premontajes exactos fuera del lugar donde finalmente se va a colocar, cuando el acceso es complicado.

PVC-U

Packs

Material embolsado hasta diámetro 63 mm. Permite tener las piezas limpias y ordenadas en todo momento. Facilita el contar los stocks así como los inventarios.

Bocas achaflanadas

Ayudan que el tubo entre más fácilmente.
El pegamento sobrante se queda depositado en la zona, cerrando y sellando la unión aún con poco pegamento.



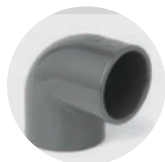

INDUSTRIA

Accesorios de PVC-U presión

Codos



GIV

| d | Ref. | PN | Pack | U/ | € |
|--------|-----------------|----|------|-------|---------------------------------|
| 12 | GIV012 | 16 | 10 | 1.000 | 1,10 |
| 16 | GIV016 ● | 16 | 10 | 500 | 0,57 |
| 20 | GIV020 ● | 16 | 10 | 260 | 0,57 |
| 25 | GIV025 ● | 16 | 10 | 150 | 0,68 |
| 32 | GIV032 ● | 16 | 10 | 120 | 1,05 |
| 40 | GIV040 ● | 16 | 10 | 80 | 1,49 |
| 50 | GIV050 ● | 16 | - | 60 | 2,19 |
| 63 | GIV063 ● | 16 | - | 50 | 3,29 |
| 75 | GIV075 ● | 16 | - | 16 | 6,17 |
| 90 | GIV090 ● | 16 | - | 20 | 10,41 |
| 110 | GIV110 ● | 16 | - | 10 | 19,35 |
| 125 | GIV125 ● | 16 | - | 6 | 27,86 |
| 140 | GIV140 ● | 16 | - | 5 | 47,67 |
| 160 | GIV160 ● | 16 | - | 4 | 55,60 |
| 180*A) | GIV180 ● | 10 | - | 4 | 81,92 |
| 200*A) | GIV200 ● | 16 | - | 2 | 87,20 |
| 225*A) | GIV225 ● | 16 | - | 2 | 126,90 |
| 250 | GIV250 ● | 10 | - | 1 | 304,28 |
| 280 | GIV280 ● | 10 | - | 1 | 566,70 |
| 315 | GIV315 ● | 10 | - | 1 | 532,44 |
| 400* | GIV400 ● | 5 | - | 1 | 1.096,35 |
| 500* | SIV500 | | | | Sólo se fabrica en curva |

Codo 90° encolar.
H-H encolar.

A) Factor de seguridad reducido



GIMV

| d x Rh | Ref. | PN | Pack | U/ | € |
|-------------|-------------------|----|------|-----|-------------|
| 16 x 3/8" | GIMV016038 | 16 | 10 | 500 | 2,14 |
| 20 x 1/2" | GIMV020012 | 16 | 10 | 260 | 2,31 |
| 25 x 3/4" | GIMV025034 | 16 | 10 | 150 | 2,72 |
| 32 x 1" | GIMV032100 | 16 | 10 | 80 | 3,45 |
| 40 x 1 1/4" | GIMV040114 | 16 | 10 | 40 | 4,45 |
| 50 x 1 1/2" | GIMV050112 | 16 | 10 | 30 | 6,35 |
| 63 x 2" | GIMV063200 | 16 | 5 | 45 | 8,39 |

Codo 90° mixto reforzado inox.
H-H encolar-rosacar.



GFV

| Rh | Ref. | PN | Pack | U/ | € |
|--------|-----------------|----|------|-----|--------------|
| 3/8" | GFV038 | 16 | 10 | 400 | 1,34 |
| 1/2" | GFV012 | 16 | 10 | 260 | 1,34 |
| 3/4" | GFV034 | 16 | 10 | 150 | 1,57 |
| 1" | GFV100 | 16 | 10 | 150 | 2,12 |
| 1 1/4" | GFV114 | 16 | 10 | 40 | 3,03 |
| 1 1/2" | GFV112 | 16 | 10 | 40 | 4,29 |
| 2" | GFV200 ● | 16 | - | 50 | 5,94 |
| 2 1/2" | GFV212 | 16 | - | 16 | 16,14 |
| 3" | GFV300 | 16 | - | 9 | 23,91 |
| 4" | GFV400 | 16 | - | 10 | 39,28 |

Codo 90° roscado.
H-H rosacar.

















GIFV

| d x Rh | Ref. | PN | Pack | U/ | € |
|-------------|---------------------|----|------|-----|--------------|
| 16 x 3/8" | GIFV016038 | 16 | 10 | 400 | 1,12 |
| 20 x 1/2" | GIFV020012 ● | 16 | 10 | 260 | 1,15 |
| 25 x 3/4" | GIFV025034 ● | 16 | 10 | 150 | 1,34 |
| 32 x 1" | GIFV032100 ● | 16 | 10 | 120 | 1,77 |
| 40 x 1 1/4" | GIFV040114 ● | 16 | 10 | 40 | 2,33 |
| 50 x 1 1/2" | GIFV050112 ● | 16 | 10 | 40 | 3,45 |
| 63 x 2" | GIFV063200 ● | 16 | - | 50 | 4,89 |
| 75 x 2 1/2" | GIFV075212 ● | 16 | - | 16 | 15,09 |
| 90 x 3" | GIFV090300 ● | 16 | - | 9 | 22,65 |
| 110 x 4" | GIFV110400 ● | 16 | - | 10 | 34,89 |

Codo 90° mixto.
H-H encolar-rosacar.

**HIV**

| d | Ref. | PN | Pack | U/  | € |
|------|--|----|------|--|--------|
| 12 | HIV012 | 16 | 10 | 800 | 1,86 |
| 16 | HIV016  | 16 | 250 | 1.000 | 0,75 |
| 20 | HIV020  | 16 | 10 | 360 | 0,75 |
| 25 | HIV025  | 16 | 10 | 200 | 0,99 |
| 32 | HIV032  | 16 | 10 | 100 | 1,34 |
| 40 | HIV040  | 16 | 10 | 50 | 1,77 |
| 50 | HIV050  | 16 | - | 40 | 2,41 |
| 63 | HIV063  | 16 | - | 30 | 3,45 |
| 75 | HIV075  | 16 | - | 12 | 6,85 |
| 90 | HIV090  | 16 | - | 6 | 10,17 |
| 110 | HIV110  | 16 | - | 6 | 17,19 |
| 125 | HIV125  | 16 | - | 10 | 24,98 |
| 140 | HIV140 | 16 | - | 6 | 40,25 |
| 160 | HIV160  | 16 | - | 4 | 49,17 |
| 180* | HIV180 | 10 | - | 1 | 153,75 |
| 200 | HIV200  | 10 | - | 2 | 72,84 |
| 225 | HIV225 | 10 | - | 2 | 143,61 |
| 250 | HIV250 | 10 | - | 1 | 249,01 |
| 280 | HIV280 | 10 | - | 1 | 494,57 |
| 315 | HIV315 | 10 | - | 1 | 469,93 |
| 400* | HIV400 | 5 | - | 1 | 920,43 |

Codo 45° encolar.

H-H encolar.



**HFV**

| Rh | Ref. | PN | Pack | U/  | € |
|--------|--------|----|------|--|-------|
| 1/2" | HFV012 | 16 | 10 | 300 | 1,62 |
| 3/4" | HFV034 | 16 | 10 | 200 | 1,89 |
| 1" | HFV100 | 16 | 10 | 120 | 2,46 |
| 1 1/4" | HFV114 | 16 | 5 | 60 | 3,11 |
| 1 1/2" | HFV112 | 16 | 5 | 30 | 4,73 |
| 2" | HFV200 | 16 | - | 30 | 6,72 |
| 2 1/2" | HFV212 | 16 | - | 12 | 24,25 |
| 3" | HFV300 | 16 | - | 6 | 32,07 |

Codo 45° roscado.

H-H roscar.

**SIV**

| d | Ref. | PN | Pack | U/  | € |
|--------|--|----|------|--|----------|
| 20 | SIV020 | 16 | 5 | 140 | 1,83 |
| 25 | SIV025 | 16 | 5 | 80 | 2,27 |
| 32 | SIV032 | 16 | 5 | 45 | 3,27 |
| 40 | SIV040  | 16 | - | 20 | 4,31 |
| 50 | SIV050 | 16 | - | 40 | 6,54 |
| 63 | SIV063 | 16 | - | 24 | 10,54 |
| 75 | SIV075 | 16 | - | 15 | 18,81 |
| 90 | SIV090  | 16 | - | 8 | 41,82 |
| 110 | SIV110 | 16 | - | 5 | 74,51 |
| 160 A) | SIV160 | 16 | - | 4 | 178,35 |
| 180* | SIV180 | 4 | - | 1 | 371,13 |
| 200* | SIV200 | 4 | - | 1 | 388,96 |
| 225*A) | SIV225 | 4 | - | 1 | 426,33 |
| 250* | SIV250 | 4 | - | 1 | 455,37 |
| 280* | SIV280 | 4 | - | 1 | 610,33 |
| 315* | SIV315 | 4 | - | 1 | 939,71 |
| 355* | SIV355 | 4 | - | 1 | 1.136,05 |
| 400* | SIV400 | 4 | - | 1 | 1.278,27 |
| 500* | SIV500 | 4 | - | 1 | 4.486,06 |

Curva a 90° encolar.

H-H encolar. R=2d

A) Factor de seguridad reducido

**SIHV***

| d | Ref. | PN | U/  | € |
|-----|---------|----|---|----------|
| 315 | SIHV315 | 4 | 1 | 1.097,57 |
| 355 | SIHV355 | 4 | 1 | 1.393,21 |
| 400 | SIHV400 | 4 | 1 | 1.685,95 |
| 500 | SIHV500 | 4 | 1 | 5.308,65 |

Curva a 45° encolar.

H-H encolar.

**XIV**

| d | Ref. | PN | Pack | U/ | € |
|----|--------|----|------|----|------|
| 25 | XIV025 | 16 | 10 | 80 | 1,89 |
| 32 | XIV032 | 16 | 10 | 50 | 2,72 |
| 40 | XIV040 | 16 | 10 | 40 | 4,45 |
| 50 | XIV050 | 16 | 10 | 20 | 5,99 |
| 63 | XIV063 | 16 | - | 12 | 8,50 |

Cruz 90° encolar.

H-H-H encolar.

**YIV**

| d | Ref. | PN | U/ | € |
|------|--------|----|-----|--------|
| 20 | YIV020 | 16 | 200 | 3,29 |
| 25 | YIV025 | 16 | 100 | 3,81 |
| 32 | YIV032 | 16 | 60 | 4,29 |
| 40 | YIV040 | 16 | 50 | 5,83 |
| 50 | YIV050 | 16 | 20 | 6,12 |
| 63 | YIV063 | 16 | 15 | 8,73 |
| 75* | YIV075 | 10 | 12 | 40,20 |
| 90* | YIV090 | 10 | 12 | 60,15 |
| 110* | YIV110 | 10 | 8 | 123,24 |
| 160* | YIV160 | 4 | 1 | 192,55 |

Te a 45° encolar.

H-H-H encolar.

**TIV**

| d | Ref. | PN | Pack | U/ | € |
|--------|--------|----|------|-----|----------|
| 12 | TIV012 | 16 | 10 | 500 | 1,31 |
| 16 | TIV016 | 16 | 10 | 300 | 0,68 |
| 20 | TIV020 | 16 | 10 | 200 | 0,68 |
| 25 | TIV025 | 16 | 10 | 100 | 0,89 |
| 32 | TIV032 | 16 | 10 | 100 | 1,29 |
| 40 | TIV040 | 16 | 10 | 60 | 2,09 |
| 50 | TIV050 | 16 | 5 | 60 | 3,01 |
| 63 | TIV063 | 16 | - | 30 | 4,29 |
| 75 | TIV075 | 16 | - | 22 | 8,97 |
| 90 | TIV090 | 16 | - | 12 | 16,47 |
| 110 | TIV110 | 16 | - | 8 | 24,11 |
| 125 | TIV125 | 16 | - | 6 | 39,51 |
| 140 | TIV140 | 16 | - | 6 | 60,03 |
| 160 | TIV160 | 16 | - | 5 | 70,90 |
| 180* | TIV180 | 10 | - | 3 | 98,26 |
| 200 A) | TIV200 | 10 | - | 2 | 113,64 |
| 225 A) | TIV225 | 10 | - | 1 | 157,87 |
| 250 | TIV250 | 10 | - | 1 | 348,63 |
| 280 | TIV280 | 10 | - | 1 | 698,47 |
| 315 | TIV315 | 10 | - | 1 | 629,29 |
| 400* | TIV400 | 4 | - | 1 | 1.557,86 |
| 500* | TIV500 | 4 | - | 1 | 4.736,23 |

Te a 90° encolar.

H-H-H encolar.

**TIFV**

| d x Rh | Ref. | PN | Pack | U/ | € |
|-------------|------------|----|------|-----|-------|
| 16 x 3/8" | TIFV016038 | 16 | 10 | 300 | 1,36 |
| 20 x 1/2" | TIFV020012 | 16 | 10 | 180 | 1,47 |
| 25 x 3/4" | TIFV025034 | 16 | 10 | 100 | 1,65 |
| 32 x 1/2" | TIFV032012 | 16 | 10 | 100 | 2,12 |
| 32 x 1" | TIFV032100 | 16 | 10 | 80 | 2,09 |
| 40 x 1 1/4" | TIFV040114 | 16 | 10 | 60 | 3,40 |
| 50 x 1/2" | TIFV050012 | 16 | 5 | 40 | 4,87 |
| 50 x 1 1/2" | TIFV050112 | 16 | 5 | 60 | 4,65 |
| 63 x 1/2" | TIFV063012 | 16 | - | 45 | 7,56 |
| 63 x 2" | TIFV063200 | 16 | - | 35 | 7,59 |
| 75 x 2 1/2" | TIFV075212 | 16 | - | 12 | 17,42 |
| 90 x 3" | TIFV090300 | 16 | - | 12 | 26,10 |
| 110 x 4" | TIFV110400 | 16 | - | 8 | 43,21 |

Te a 90° mixta.

H-H-H encolar-rosocar.



TIMV

| d x Rh | Ref. | PN | Pack | U/ | € |
|-------------|------------|----|------|-----|-------|
| 16 x 3/8" | TIMV016038 | 16 | 10 | 180 | 2,36 |
| 20 x 1/2" | TIMV020012 | 16 | 10 | 180 | 2,64 |
| 25 x 3/4" | TIMV025034 | 16 | 10 | 100 | 3,03 |
| 32 x 1" | TIMV032100 | 16 | 10 | 60 | 3,79 |
| 40 x 1 1/4" | TIMV040114 | 16 | 10 | 30 | 5,44 |
| 50 x 1 1/2" | TIMV050112 | 16 | 5 | 20 | 7,56 |
| 63 x 2" | TIMV063200 | 16 | - | 10 | 10,99 |

Te a 90° mixta reforzada inox.
H-H-H encolar-rosocar.



TFV

| Rh | Ref. | PN | Pack | U/ | € |
|--------|--------|----|------|-----|-------|
| 3/8" | TFV038 | 16 | 10 | 300 | 1,75 |
| 1/2" | TFV012 | 16 | 10 | 180 | 2,09 |
| 3/4" | TFV034 | 16 | 10 | 90 | 2,27 |
| 1" | TFV100 | 16 | 10 | 80 | 2,83 |
| 1 1/4" | TFV114 | 16 | 10 | 60 | 4,45 |
| 1 1/2" | TFV112 | 16 | 5 | 60 | 6,20 |
| 2" | TFV200 | 16 | - | 30 | 9,88 |
| 2 1/2" | TFV212 | 16 | - | 12 | 20,08 |
| 3" | TFV300 | 16 | - | 12 | 26,62 |
| 4" | TFV400 | 16 | - | 8 | 48,73 |

Te a 90° roscada.
H-H-H rosocar.



TRIV

| d x Rh | Ref. | PN | Pack | U/ | € |
|---------|------------|----|------|-----|-------|
| 25 x 20 | TRIV025020 | 16 | 10 | 120 | 1,12 |
| 32 x 20 | TRIV032020 | 16 | 10 | 100 | 1,54 |
| 32 x 25 | TRIV032025 | 16 | 10 | 90 | 1,54 |
| 40 x 20 | TRIV040020 | 16 | 10 | 60 | 2,64 |
| 40 x 25 | TRIV040025 | 16 | 10 | 60 | 2,64 |
| 40 x 32 | TRIV040032 | 16 | 10 | 60 | 2,64 |
| 50 x 20 | TRIV050020 | 16 | 5 | 40 | 3,43 |
| 50 x 25 | TRIV050025 | 16 | 5 | 70 | 3,43 |
| 50 x 32 | TRIV050032 | 16 | 5 | 60 | 3,43 |
| 50 x 40 | TRIV050040 | 16 | 5 | 30 | 3,43 |
| 63 x 25 | TRIV063025 | 16 | - | 45 | 5,70 |
| 63 x 32 | TRIV063032 | 16 | - | 45 | 5,70 |
| 63 x 40 | TRIV063040 | 16 | - | 45 | 5,70 |
| 63 x 50 | TRIV063050 | 16 | - | 40 | 5,70 |
| 75 x 32 | TRIV075032 | 16 | - | 18 | 9,68 |
| 75 x 40 | TRIV075040 | 16 | - | 16 | 9,68 |
| 75 x 50 | TRIV075050 | 16 | - | 13 | 9,68 |
| 75 x 63 | TRIV075063 | 16 | - | 12 | 9,68 |
| 90 x 40 | TRIV090040 | 16 | - | 15 | 17,13 |
| 90 x 50 | TRIV090050 | 16 | - | 15 | 17,13 |
| 90 x 63 | TRIV090063 | 16 | - | 12 | 17,13 |
| 90 x 75 | TRIV090075 | 16 | - | 12 | 17,13 |

Te a 90° reducida encolar.
H-H-H encolar.

| d x Rh | Ref. | PN | Pack | U/ | € |
|------------|------------|----|------|----|----------|
| 110 x 50 | TRIV110050 | 16 | - | 10 | 24,53 |
| 110 x 63 | TRIV110063 | 16 | - | 8 | 24,53 |
| 110 x 75 | TRIV110075 | 16 | - | 8 | 24,53 |
| 110 x 90 | TRIV110090 | 16 | - | 8 | 24,53 |
| 125 x 50* | TRIV125050 | 16 | - | 1 | 82,72 |
| 125 x 63* | TRIV125063 | 16 | - | 1 | 82,72 |
| 125 x 75* | TRIV125075 | 16 | - | 1 | 82,72 |
| 125 x 90* | TRIV125090 | 16 | - | 1 | 82,72 |
| 125 x 110* | TRIV125110 | 16 | - | 1 | 82,72 |
| 160 x 110 | TRIV160110 | 16 | - | 3 | 72,34 |
| 200 x 90* | TRIV200090 | 10 | - | 1 | 238,16 |
| 200 x 110* | TRIV200110 | 10 | - | 1 | 238,16 |
| 200 x 160* | TRIV200160 | 10 | - | 1 | 238,16 |
| 250 x 110* | TRIV250110 | 10 | - | 1 | 394,29 |
| 250 x 160* | TRIV250160 | 10 | - | 1 | 394,29 |
| 250 x 200* | TRIV250200 | 10 | - | 1 | 394,29 |
| 280 x 225* | TRIV280225 | 10 | - | 1 | 597,57 |
| 315 x 200* | TRIV315200 | 8 | - | 1 | 733,09 |
| 315 x 250* | TRIV315250 | 8 | - | 1 | 733,09 |
| 400 x 110* | TRIV400110 | 5 | - | 1 | 1.053,79 |
| 400 x 315* | TRIV400315 | 4 | - | 1 | 1.557,86 |
| 400 x 355* | TRIV400355 | 4 | - | 1 | 1.557,86 |



MIV

| d | Ref. | PN | Pack | U/ | € |
|--------|--------|----|------|-------|--------|
| 12 | MIV012 | 16 | 10 | 1.000 | 1,10 |
| 16 | MIV016 | 16 | 10 | 600 | 0,65 |
| 20 | MIV020 | 16 | 10 | 360 | 0,63 |
| 25 | MIV025 | 16 | 10 | 270 | 0,75 |
| 32 | MIV032 | 16 | 10 | 150 | 0,89 |
| 40 | MIV040 | 16 | 10 | 80 | 1,34 |
| 50 | MIV050 | 16 | 10 | 40 | 1,72 |
| 63 | MIV063 | 16 | - | 40 | 2,54 |
| 75 | MIV075 | 16 | - | 24 | 5,23 |
| 90 | MIV090 | 16 | - | 28 | 6,75 |
| 110 | MIV110 | 16 | - | 24 | 11,17 |
| 125 | MIV125 | 16 | - | 14 | 17,19 |
| 140 | MIV140 | 16 | - | 8 | 25,42 |
| 160 | MIV160 | 16 | - | 6 | 34,39 |
| 180* | MIV180 | 10 | - | 1 | 112,25 |
| 200 A) | MIV200 | 16 | - | 6 | 51,45 |
| 225 A) | MIV225 | 16 | - | 2 | 84,01 |
| 250 | MIV250 | 10 | - | 2 | 171,15 |
| 280 | MIV280 | 10 | - | 2 | 277,49 |
| 315 | MIV315 | 10 | - | 1 | 239,97 |
| 355* | MIV355 | 5 | - | 1 | 370,29 |
| 400* | MIV400 | 5 | - | 1 | 411,66 |
| 500* | MIV500 | 4 | - | 1 | 520,72 |

Manguito encolar.

H-H encolar.



MIMV

| d x Rh | Ref. | PN | Pack | U/ | € |
|-------------|------------|----|------|-----|------|
| 16 x 3/8" | MIMV016038 | 16 | 10 | 600 | 1,91 |
| 20 x 1/2" | MIMV020012 | 16 | 10 | 400 | 2,07 |
| 25 x 3/4" | MIMV025034 | 16 | 10 | 240 | 2,38 |
| 32 x 1" | MIMV032100 | 16 | 10 | 120 | 2,77 |
| 40 x 1 1/4" | MIMV040114 | 16 | 10 | 80 | 3,51 |
| 50 x 1 1/2" | MIMV050112 | 16 | 10 | 40 | 4,58 |
| 63 x 2" | MIMV063200 | 16 | 5 | 25 | 6,07 |

Manguito mixto reforzado inox.

H-H encolar-rosacar.



MIFV

| d x Rh | Ref. | PN | Pack | U/ | € |
|--------------|------------|----|------|-----|-------|
| 16 x 3/8" | MIFV016038 | 16 | 10 | 600 | 1,15 |
| 20 x 1/2" | MIFV020012 | 16 | 10 | 300 | 1,15 |
| 25 x 3/4" | MIFV025034 | 16 | 10 | 200 | 1,34 |
| 32 x 1" | MIFV032100 | 16 | 10 | 100 | 1,47 |
| 40 x 1 1/4" | MIFV040114 | 16 | 10 | 80 | 1,94 |
| 50 x 1 1/2" | MIFV050112 | 16 | 10 | 50 | 2,51 |
| 63 x 2" | MIFV063200 | 16 | - | 25 | 3,58 |
| 75 x 2 1/2** | 1RMA375H00 | 16 | - | 75 | 15,07 |
| 90 x 3** | 1RMA390I00 | 16 | - | 40 | 16,66 |
| 110 x 4** | 1RMA311L00 | 16 | - | 25 | 37,91 |

Manguito mixto.

H-H encolar-rosacar.



MFV

| Rh | Ref. | PN | Pack | U/ | € |
|--------|--------|----|------|-----|-------|
| 3/8" | MFV038 | 16 | 10 | 600 | 1,39 |
| 1/2" | MFV012 | 16 | 10 | 300 | 1,36 |
| 3/4" | MFV034 | 16 | 10 | 240 | 1,59 |
| 1" | MFV100 | 16 | 10 | 100 | 1,94 |
| 1 1/4" | MFV114 | 16 | 10 | 80 | 2,51 |
| 1 1/2" | MFV112 | 16 | 10 | 40 | 3,40 |
| 2" | MFV200 | 16 | - | 25 | 4,55 |
| 2 1/2" | MFV212 | 16 | - | 20 | 10,99 |
| 3" | MFV300 | 16 | - | 8 | 15,45 |
| 4" | MFV400 | 16 | - | 10 | 24,03 |

Manguito roscado.

H-H rosacar.



DIMV

| dm x dh x Rh | Ref. | PN | Pack | U/ | € |
|------------------|--------------|----|------|-----|-------|
| 20 x 16 x 3/8" | DIMV20016038 | 16 | 10 | 500 | 3,24 |
| 20 x 16 x 1/2" | DIMV20016012 | 16 | 10 | 250 | 4,29 |
| 25 x 20 x 1/2" | DIMV25020012 | 16 | 10 | 300 | 4,29 |
| 25 x 20 x 3/4" | DIMV25020034 | 16 | 10 | 100 | 5,07 |
| 32 x 25 x 3/4" | DIMV32025034 | 16 | 10 | 160 | 5,13 |
| 32 x 25 x 1" | DIMV32025100 | 16 | 10 | 120 | 5,39 |
| 40 x 32 x 1" | DIMV40032100 | 16 | 10 | 100 | 5,42 |
| 40 x 32 x 1 1/4" | DIMV40032114 | 16 | 10 | 40 | 9,60 |
| 50 x 40 x 1 1/4" | DIMV50040114 | 16 | 10 | 40 | 9,60 |
| 50 x 40 x 1 1/2" | DIMV50040112 | 16 | 5 | 30 | 10,83 |
| 63 x 50 x 1 1/2" | DIMV63050112 | 16 | 5 | 30 | 10,83 |
| 63 x 50 x 2" | DIMV63050200 | 16 | 5 | 30 | 14,73 |
| 75 x 63 x 2" | DIMV75063200 | 16 | - | 45 | 14,73 |

Doble adaptador mixto M/H-H reforzado inox.

M-H encolar - H rosacar.

dm = diám.macho

dh = diám.hembra

Rh = diám.hembra

**DIFV**

| dm x dh x Rh | Ref. | PN | Pack | U/  | € |
|------------------|--------------|----|------|--|-------|
| 20 x 16 x 3/8" | DIFV20016038 | 16 | 10 | 500 | 1,23 |
| 20 x 16 x 1/2" | DIFV20016012 | 16 | 10 | 400 | 1,23 |
| 25 x 20 x 1/2" | DIFV25020012 | 16 | 10 | 300 | 1,47 |
| 25 x 20 x 3/4" | DIFV25020034 | 16 | 10 | 200 | 1,47 |
| 32 x 25 x 3/4" | DIFV32025034 | 16 | 10 | 130 | 1,94 |
| 32 x 25 x 1" | DIFV32025100 | 16 | 10 | 120 | 1,94 |
| 40 x 32 x 1" | DIFV40032100 | 16 | 10 | 100 | 2,51 |
| 40 x 32 x 1 1/4" | DIFV40032114 | 16 | 10 | 80 | 2,51 |
| 50 x 40 x 1 1/4" | DIFV50040114 | 16 | 10 | 60 | 3,56 |
| 50 x 40 x 1 1/2" | DIFV50040112 | 16 | 10 | 40 | 3,56 |
| 63 x 50 x 1 1/2" | DIFV63050112 | 16 | - | 30 | 5,33 |
| 63 x 50 x 2" | DIFV63050200 | 16 | - | 24 | 5,33 |
| 75 x 63 x 2" | DIFV75063200 | 16 | - | 45 | 7,48 |
| 75 x 63 x 2 1/2" | DIFV75063212 | 16 | - | 24 | 7,48 |
| 90 x 75 x 2 1/2" | DIFV90075212 | 16 | - | 20 | 13,29 |
| 90 x 75 x 3" | DIFV90075300 | 16 | - | 8 | 13,29 |
| 110 x 90 x 3" | DIFV11090300 | 16 | - | 6 | 18,15 |
| 110 x 90 x 4" | DIFV11090400 | 16 | - | 5 | 18,15 |
| 125 x 110 x 4" | DIFV12110400 | 16 | - | 6 | 33,76 |

Doble adaptador mixto M/H-H

dm = diám.macho
dh = diám.hembra
Rh = diám.hembra

M-H encolar - H rosacar.

**QPV PLANO**
QRV ESTRIADO

| d | Ref. | PN | Pack | U/  | € |
|-----------|--------|----|------|--|--------|
| 20 + | QPV020 | 16 | 10 | 500 | 1,20 |
| 25 + | QPV025 | 16 | 10 | 340 | 1,44 |
| 32 + | QPV032 | 16 | 10 | 200 | 1,54 |
| 40 | QPV040 | 16 | 10 | 110 | 1,99 |
| 50 | QPV050 | 16 | 10 | 80 | 2,49 |
| 63 | QPV063 | 16 | - | 48 | 3,03 |
| 75 | QPV075 | 16 | - | 20 | 6,57 |
| 90 | QPV090 | 16 | - | 48 | 6,27 |
| 110 | QPV110 | 16 | - | 32 | 7,84 |
| 125 | QPV125 | 16 | - | 7 | 10,35 |
| 140 | QPV140 | 16 | - | 8 | 26,25 |
| 160 | QPV160 | 16 | - | 10 | 19,09 |
| 180* | QPV180 | 16 | - | 1 | 73,47 |
| 200 A) | QPV200 | 16 | - | 6 | 34,91 |
| 225 -- A) | QRV225 | 16 | - | 6 | 58,06 |
| 250 -- A) | QRV250 | 10 | - | 6 | 93,27 |
| 280* -- | QRV280 | 10 | - | 4 | 154,72 |
| 315 -- | QRV315 | 10 | - | 3 | 144,89 |
| 355*+ | QPV355 | 5 | - | 1 | 253,43 |
| 400* | QRV400 | 5 | - | 1 | 304,17 |
| 500*+ | QPV500 | 4 | - | 1 | 376,75 |

Manguito portabridas encolar. +Sólo QPV -- Sólo QRV
H encolar (junta no incluida). A) Factor de seguridad reducido.
Código portabridas plano, para estriado cambiar QPV por QRV



FDV

| d | Ref. | DN | T PN | U/  | € |
|-----|--------|----|------|--|-------|
| 25 | FDV025 | 20 | 10 | 80 | 5,42 |
| 32 | FDV032 | 25 | 10 | 48 | 6,51 |
| 40 | FDV040 | 32 | 10 | 24 | 8,50 |
| 50 | FDV050 | 40 | 10 | 20 | 9,97 |
| 63 | FDV063 | 50 | 10 | 14 | 12,39 |
| 75 | FDV075 | 65 | 10 | 12 | 13,03 |
| 90 | FDV090 | 75 | 10 | 12 | 15,07 |
| 110 | FDV110 | 90 | 10 | 6 | 18,41 |

Brida con manguito encolar.

T = Taladros

H encolar (junta no incluida).



QPV FK/FE

| d | Ref. | DN | PN | € |
|---------|-----------|-----|----|--------|
| 125 (2) | QPV125FKE | 125 | 16 | 43,02 |
| 200 (3) | QPV200FKE | 200 | 16 | 108,17 |

Portabridas especial para válvula de mariposa FE/FK. (2) Convierte la válvula de mariposa de 140 en 125. Usar con brida ODV 140 PVC-U.

Para rebajar el diámetro. (3) Convierte la válvula de mariposa de 225 en 200. Usar con brida ODV 225 PVC-U.



ODB

| d | Ref. | DN | € |
|-------|--------------|-----|--------|
| 20 | ODB020 | 15 | 8,85 |
| 25 | ODB025 | 20 | 9,72 |
| 32 | ODB032 | 25 | 12,51 |
| 40 | ODB040 | 32 | 15,18 |
| 50 | ODB050 | 40 | 17,75 |
| 63 | ODB063 | 50 | 22,08 |
| 75 | ODB075 | 65 | 24,40 |
| 90 | ODB090 | 80 | 29,06 |
| 125* | ODB125 | 100 | 35,07 |
| 140 | ODBD140DN125 | 125 | 55,06 |
| 180** | ODB180 | 150 | 61,24 |
| 200 | ODB200 | 200 | 80,21 |
| 225 | ODBD225DN200 | 200 | 113,15 |
| 280 | ODBD280DN250 | 250 | 117,15 |
| 315 | ODBD315DN300 | 300 | 171,56 |

Brida loca PP negro con alma de acero.

EN ISO/DIN - PN 10 / 16 hasta PN 150 - PN 10 DN 200

* Para QPV 110, QRV 110. ** Para QPV 160, QRV 160.

Ver descuentos aplicables según "Familia PP"



ODV

| d | Ref. | T PN | Pack | U/  | € |
|------|--------|------|------|--|--------|
| 20 | ODV020 | 10 | - | 250 | 3,14 |
| 25 | ODV025 | 10 | - | 200 | 3,58 |
| 32 | ODV032 | 10 | - | 120 | 4,00 |
| 40 | ODV040 | 10 | - | 60 | 4,63 |
| 50 | ODV050 | 10 | - | 65 | 6,76 |
| 63 | ODV063 | 10 | 2 | 30 | 7,30 |
| 75 | ODV075 | 10 | 2 | 16 | 7,43 |
| 90 | ODV090 | 10 | 2 | 24 | 7,93 |
| 110 | ODV110 | 10 | 2 | 20 | 10,75 |
| 125 | ODV125 | 10 | - | 16 | 15,45 |
| 140 | ODV140 | 10 | - | 16 | 17,57 |
| 160 | ODV160 | 10 | - | 18 | 21,24 |
| 180* | ODV180 | 10 | - | - | 67,89 |
| 200 | ODV200 | 10 | - | 9 | 25,63 |
| 225 | ODV225 | 10 | - | 10 | 29,16 |
| 250 | ODV250 | 10 | - | 11 | 83,30 |
| 280 | ODV280 | 10 | - | 12 | 121,65 |
| 315 | ODV315 | 10 | - | 8 | 126,80 |
| 355* | ODV355 | 4 | - | 1 | 204,13 |
| 400* | ODV400 | 4 | - | 1 | 219,69 |
| 500* | ODV500 | 6 | - | 1 | 329,38 |
| 500* | ODV510 | 10 | - | 1 | 363,69 |

Brida loca PVC-U para manguito portabridas. T = Taladros



FCV

| d | Ref. | T | PN | Pack | U/  | € |
|------|--------|----|----|------|--|--------|
| 25 | FCV025 | 10 | 2 | 40 | | 5,18 |
| 32 | FCV032 | 10 | 2 | 60 | | 6,91 |
| 40 | FCV040 | 10 | 2 | 50 | | 9,00 |
| 50 | FCV050 | 10 | - | 30 | | 10,99 |
| 63 | FCV063 | ● | 10 | - | 30 | 13,53 |
| 75 | FCV075 | 10 | 2 | 26 | | 17,76 |
| 90 | FCV090 | ● | 10 | 2 | 24 | 20,48 |
| 110 | FCV110 | ● | 10 | 2 | 18 | 26,91 |
| 140* | FCV140 | 10 | - | 1 | | 57,96 |
| 160* | FCV160 | 10 | - | 1 | | 84,69 |
| 180* | FCV180 | 10 | - | 1 | | 108,12 |
| 200* | FCV200 | 10 | - | 1 | | 107,00 |
| 225* | FCV225 | 10 | - | 1 | | 107,00 |
| 250* | FCV250 | 8 | - | 1 | | 217,94 |
| 280* | FCV280 | 8 | - | 1 | | 217,94 |
| 315* | FCV315 | 6 | - | 1 | | 434,00 |

Brida Ciega.

T = Taladros



LIFV

| d x Rm x Rh | Ref. | PN | Junta | Pack | U/  | € |
|------------------|------------|----|-------|------|--|-------|
| 16 x 3/4" x 3/8" | 1RAS316B00 | 16 | EPDM | 5 | 125 | 19,01 |
| 20 x 1" x 3/4" | 1RAS320C00 | 16 | EPDM | 5 | 125 | 23,96 |
| 25 x 1 1/4" x 1" | 1RAS325D00 | 16 | EPDM | 5 | 90 | 27,33 |
| 32 x 1 1/2" x 1" | 1RAS332D00 | 16 | EPDM | - | 60 | 34,08 |
| 40 x 2" x 1 1/2" | 1RAS340F00 | 16 | EPDM | - | 35 | 51,29 |
| 16 x 3/4" x 1/2" | 1RAS316B10 | 16 | FKM | 5 | 125 | 21,24 |
| 20 x 1" x 3/4" | 1RAS320C10 | 16 | FKM | 5 | 125 | 28,01 |
| 25 x 1 1/4" x 1" | 1RAS325D10 | 16 | FKM | 5 | 90 | 31,70 |
| 32 x 1 1/2" x 1" | 1RAS332D10 | 16 | FKM | - | 60 | 42,79 |
| 40 x 2" x 1 1/2" | 1RAS340F10 | 16 | FKM | - | 35 | 60,88 |

Adaptador depósito.

H encolar - M-H roscar. Junta plana iuncluida.



LIV

| d x Rm | Ref. | PN | Pack | U/  | € EPDM |
|-------------|-----------|----|------|--|--------|
| 25 x 1" | LIV025100 | 16 | 10 | 100 | 11,40 |
| 32 x 1 1/4" | LIV032114 | 16 | 10 | 40 | 13,29 |

Adaptador depósito.

M-M encolar - roscar. Junta plana incluida.



LIFV-J

| d x Rm x Rh | Ref. | € EPDM | € FKM |
|------------------|---------|--------|-------|
| 16 x 3/4" x 1/2" | GP0195E | 1,36 | 5,31 |
| 20 x 1" x 3/4" | GP2299E | 2,56 | 14,83 |
| 25 x 1 1/4" x 1" | GP0200E | 2,98 | 15,90 |
| 32 x 1 1/2" x 1" | GP0201E | 3,76 | 22,91 |
| 40 x 2" x 1 1/2" | GP0202E | 5,37 | 37,32 |

Junta plana para adaptador depósito.

Código en FKM termina en "F"

en lugar de "E"



LIV-J

| d x Rm | Ref. | € EPDM |
|-------------|---------|--------|
| 25 x 1" | GP1205E | 0,79 |
| 32 x 1 1/4" | GP1206E | 1,10 |

Junta plana para adaptador depósito.

Junta en EPDM.



DIV

| d x d1 | Ref. | PN | Pack | U/  | € |
|-----------|------------------|------|------|--|--------------|
| 16 x 12 | DIV016012 | ● 16 | 10 | 1.000 | 1,59 |
| 20 x 16 | DIV020016 | ● 16 | 10 | 1.000 | 0,47 |
| 25 x 20 | DIV025020 | ● 16 | 10 | 600 | 0,57 |
| 32 x 20 | DIV032020 | ● 16 | 10 | 400 | 0,68 |
| 32 x 25 | DIV032025 | ● 16 | 10 | 400 | 0,63 |
| 40 x 20 | DIV040020 | ● 16 | 10 | 240 | 0,99 |
| 40 x 25 | DIV040025 | ● 16 | 10 | 240 | 0,99 |
| 40 x 32 | DIV040032 | ● 16 | 10 | 240 | 0,79 |
| 50 x 32 | DIV050032 | ● 16 | 10 | 120 | 1,36 |
| 50 x 40 | DIV050040 | ● 16 | 10 | 120 | 0,97 |
| 63 x 32 | DIV063032 | ● 16 | - | 70 | 1,81 |
| 63 x 40 | DIV063040 | ● 16 | - | 70 | 1,81 |
| 63 x 50 | DIV063050 | ● 16 | - | 60 | 1,29 |
| 75 x 50 | DIV075050 | ● 16 | - | 56 | 2,72 |
| 75 x 63 | DIV075063 | ● 16 | - | 56 | 2,31 |
| 90 x 50 | DIV090050 | ● 16 | - | 100 | 4,35 |
| 90 x 63 | DIV090063 | ● 16 | - | 100 | 4,35 |
| 90 x 75 | DIV090075 | ● 16 | - | 100 | 3,76 |
| 110 x 63 | DIV110063 | ● 16 | - | 60 | 8,34 |
| 110 x 75 | DIV110075 | ● 16 | - | 60 | 8,26 |
| 110 x 90 | DIV110090 | ● 16 | - | 60 | 7,27 |
| 125 x 110 | DIV125110 | ● 16 | - | 12 | 9,47 |
| 140 x 90 | DIV140090 | ● 16 | - | 16 | 13,49 |
| 140 x 110 | DIV140110 | ● 16 | - | 16 | 14,41 |

Casquillo reducción encolar.

M-H encolar.

d = diám.macho

d1 = diám.hembra

| d x d1 | Ref. | PN | Pack | U/  | € |
|---------------|-------------------|------|------|--|---------------|
| 140 x 125 | DIV140125 | ● 16 | - | 16 | 12,84 |
| 160 x 90 | DIV160090 | ● 16 | - | 9 | 18,26 |
| 160 x 110 | DIV160110 | ● 16 | - | 9 | 19,01 |
| 160 x 140 | DIV160140 | ● 16 | - | 9 | 16,79 |
| 180 x 160* | DIV180160 | ● 10 | - | 1 | 52,54 |
| 200 x 160* | 1RRC121O00 | ● 16 | - | 10 | 45,14 |
| 200 x 180* | DIV200180 | ● 10 | - | 1 | 52,83 |
| 225 x 160 A) | DIV225160 | ● 16 | - | 6 | 43,76 |
| 225 x 200 A)* | DIV225200 | ● 16 | - | 6 | 35,60 |
| 250 x 160 | DIV250160 | ● 10 | - | 6 | 76,13 |
| 250 x 180* | DIV250180 | ● 10 | - | 1 | 158,18 |
| 250 x 200 | DIV250200 | ● 10 | - | 6 | 65,18 |
| 250 x 225 | DIV250225 | ● 10 | - | 6 | 63,87 |
| 280 x 200* | DIV280200 | ● 10 | - | 1 | 178,58 |
| 280 x 225* | DIV280225 | ● 10 | - | 4 | 178,58 |
| 280 x 250* | DIV280250 | ● 10 | - | 1 | 178,58 |
| 315 x 200 | DIV315200 | ● 10 | - | 3 | 192,68 |
| 315 x 225 | DIV315225 | ● 10 | - | 3 | 195,50 |
| 315 x 250 | DIV315250 | ● 10 | - | 4 | 191,19 |
| 315 x 280 | DIV315280 | ● 10 | - | 4 | 190,97 |
| 400 x 280* | DIV400280 | ● 5 | - | 1 | 315,36 |
| 400 x 315* | DIV400315 | ● 5 | - | 1 | 273,18 |
| 400 x 355* | DIV400355 | ● 5 | - | 1 | 273,18 |

A) Factor de seguridad reducido



RIV

| d x d2 x d1 | Ref. | PN | Pack | U/ | € |
|--------------|--------------|----|------|-----|------|
| 16 x 12 | RIV016012 | 16 | 10 | 800 | 0,73 |
| 20 x 16 | RIV020016 | 16 | 10 | 500 | 0,73 |
| 25 x 20 x 16 | RIV025020016 | 16 | 10 | 400 | 0,79 |
| 25 x 20 x 20 | RIV025020020 | 16 | 10 | 340 | 0,79 |
| 32 x 25 x 16 | RIV032025016 | 16 | 10 | 280 | 0,79 |
| 32 x 25 x 20 | RIV032025020 | 16 | 10 | 240 | 0,87 |
| 32 x 25 x 25 | RIV032025025 | 16 | 10 | 200 | 0,87 |
| 40 x 32 x 20 | RIV040032020 | 16 | 10 | 120 | 1,07 |
| 40 x 32 x 25 | RIV040032025 | 16 | 10 | 120 | 1,07 |
| 40 x 32 x 32 | RIV040032032 | 16 | 10 | 120 | 1,07 |
| 50 x 40 x 20 | RIV050040020 | 16 | 10 | 80 | 1,54 |
| 50 x 40 x 25 | RIV050040025 | 16 | 10 | 80 | 1,54 |
| 50 x 40 x 32 | RIV050040032 | 16 | 10 | 80 | 1,54 |
| 50 x 40 x 40 | RIV050040040 | 16 | 10 | 60 | 1,54 |
| 63 x 50 x 25 | RIV063050025 | 16 | - | 40 | 2,49 |
| 63 x 50 x 32 | RIV063050032 | 16 | - | 40 | 2,49 |
| 63 x 50 x 40 | RIV063050040 | 16 | - | 40 | 2,49 |
| 63 x 50 x 50 | RIV063050050 | 16 | - | 35 | 2,49 |

Reducción cónica encolar.

M-H encolar.

d = diámetro macho

d2 y d1 = diámetros hembra



MRIV*

| d2 x d1 | Ref. | PN | U/ | € |
|-----------|------------|----|----|--------|
| 125 x 110 | MRIV125110 | 10 | 1 | 57,51 |
| 140 x 110 | MRIV140110 | 10 | 1 | 76,71 |
| 140 x 125 | MRIV140125 | 10 | 1 | 76,71 |
| 160 x 110 | MRIV160110 | 10 | 1 | 78,77 |
| 160 x 125 | MRIV160125 | 10 | 1 | 81,63 |
| 160 x 140 | MRIV160140 | 10 | 1 | 78,77 |
| 200 x 110 | MRIV200110 | 10 | 1 | 152,19 |
| 200 x 125 | MRIV200125 | 10 | 1 | 152,19 |
| 200 x 140 | MRIV200140 | 10 | 1 | 152,19 |
| 200 x 160 | MRIV200160 | 10 | 1 | 152,19 |
| 200 x 180 | MRIV200180 | 10 | 1 | 152,19 |
| 225 x 110 | MRIV225110 | 10 | 1 | 195,69 |
| 225 x 125 | MRIV225125 | 10 | 1 | 195,69 |
| 225 x 140 | MRIV225140 | 10 | 1 | 190,11 |
| 225 x 160 | MRIV225160 | 10 | 1 | 190,11 |
| 225 x 200 | MRIV225200 | 10 | 1 | 190,11 |
| 250 x 110 | MRIV250110 | 10 | 1 | 245,92 |
| 250 x 125 | MRIV250125 | 10 | 1 | 245,92 |
| 250 x 140 | MRIV250140 | 10 | 1 | 245,92 |
| 250 x 160 | MRIV250160 | 10 | 1 | 238,97 |
| 250 x 180 | MRIV250180 | 10 | 1 | 238,97 |
| 250 x 200 | MRIV250200 | 10 | 1 | 238,97 |

Manguito reducido encolar.

H-H encolar.

| d x d1 | Ref. | PN | Pack | U/ | € |
|----------------------|--------------|----|------|----|--------|
| 75 x 63 x 50 | RIV075063050 | 16 | - | 24 | 3,98 |
| 75 x 63 x 63 | RIV075063063 | 16 | - | 24 | 3,98 |
| 90 x 75 x 50 x 40 B) | RIV090075040 | 16 | - | 24 | 5,18 |
| 90 x 75 x 63 x 50 B) | RIV090075050 | 16 | - | 16 | 5,18 |
| 90 x 75 x 75 x 63 B) | RIV090075063 | 16 | - | 24 | 5,18 |
| 90 x 75 x 90 x 75 B) | RIV090075075 | 16 | - | 12 | 5,18 |
| 110 x 90 x 50 | RIV110090050 | 16 | - | 15 | 9,45 |
| 110 x 90 x 63 | RIV110090063 | 16 | - | 12 | 9,45 |
| 110 x 90 x 75 | RIV110090075 | 16 | - | 12 | 9,45 |
| 110 x 90 x 90 | RIV110090090 | 16 | - | 10 | 9,45 |
| 125 x 110 x 63* | RIV125063 | 16 | - | 1 | 40,83 |
| 125 x 110 x 75* | RIV125075 | 16 | - | 1 | 34,68 |
| 125 x 110 x 90* | RIV125090 | 16 | - | 1 | 34,68 |
| 140 x 125 x 75* | RIV140075 | 16 | - | 1 | 57,80 |
| 140 x 125 x 90* | RIV140090 | 16 | - | 1 | 52,05 |
| 140 x 125 x 110* | RIV140110 | 16 | - | 1 | 52,05 |
| 160 x 140 x 90* | RIV160090 | 16 | - | 1 | 104,94 |
| 160 x x 110 | RIV160110 | 16 | - | 12 | 22,54 |
| 200 x x 160 | RIV200160 | 16 | - | 8 | 49,33 |

B) 4 diámetros M-H / M-H

d2 y d1 = diámetros hembra

**CIV**

| d | Ref. | PN | Pack | U/  | € |
|------|-----------------|----|------|--|---------------|
| 12 | CIV012 | 16 | 10 | 1.000 | 1,10 |
| 16 | CIV016 | 16 | 10 | 1.000 | 0,57 |
| 20 | CIV020 ● | 16 | 10 | 600 | 0,57 |
| 25 | CIV025 ● | 16 | 10 | 400 | 0,60 |
| 32 | CIV032 ● | 16 | 10 | 240 | 0,81 |
| 40 | CIV040 ● | 16 | 10 | 140 | 1,23 |
| 50 | CIV050 ● | 16 | 10 | 80 | 1,77 |
| 63 | CIV063 ● | 16 | - | 60 | 2,49 |
| 75 | CIV075 ● | 16 | - | 28 | 4,68 |
| 90 | CIV090 ● | 16 | - | 15 | 7,64 |
| 110 | CIV110 ● | 16 | - | 10 | 15,45 |
| 125 | CIV125 | 16 | - | 6 | 21,65 |
| 140 | CIV140 | 16 | - | 4 | 28,29 |
| 160 | CIV160 ● | 16 | - | 4 | 32,72 |
| 200* | CIV200 ● | 10 | - | 7 | 47,07 |
| 225 | CIV225 | 10 | - | 2 | 76,47 |
| 250* | CIV250 | 10 | - | 1 | 162,47 |

Tapón encolar hembra.
H encolar.

**CFV**

| Rh | Ref. | PN | Pack | U/  | € |
|--------|-------------------|----|------|---|--------------|
| 3/8" | 1RCA216000 | 16 | 10 | 1.000 | 1,77 |
| 1/2" | CFV012 ● | 16 | 10 | 500 | 1,10 |
| 3/4" | CFV034 | 16 | 10 | 400 | 1,20 |
| 1" | CFV100 | 16 | 10 | 200 | 1,49 |
| 1 1/4" | CFV114 | 16 | 10 | 140 | 2,09 |
| 1 1/2" | CFV112 | 16 | 10 | 90 | 2,72 |
| 2" | CFV200 | 16 | - | 50 | 3,61 |
| 2 1/2" | CFV212 | 16 | - | 70 | 13,47 |
| 3" | CFV300 | 16 | - | 20 | 13,81 |
| 4" | CFV400 | 16 | - | 60 | 23,80 |

Tapón rosca hembra.
H roscar.

**PFV**

| Rm | Ref. | PN | Pack | U/  | € |
|--------|-----------------|----|------|--|--------------|
| 3/8" | PFV038 | 16 | 10 | 1.000 | 0,65 |
| 1/2" | PFV012 ● | 16 | 10 | 300 | 0,79 |
| 3/4" | PFV034 | 16 | 10 | 400 | 0,94 |
| 1" | PFV100 ● | 16 | 10 | 260 | 1,34 |
| 1 1/4" | PFV114 | 16 | 10 | 120 | 1,77 |
| 1 1/2" | PFV112 | 16 | 10 | 100 | 2,31 |
| 2" | PFV200 | 16 | - | 60 | 2,72 |
| 2 1/2" | PFV212 | 16 | - | 36 | 4,83 |
| 3" | PFV300 | 16 | - | 20 | 7,79 |
| 4" | PFV400 | 16 | - | 8 | 15,25 |

Tapón rosca macho.
M roscar.

**DFV**

| Rm x Rh | Ref. | PN | Pack | U/  | € |
|-----------------|--------------------|----|------|---|-------------|
| 1/2" x 3/8" | DFV012038 ● | 16 | 10 | 600 | 1,34 |
| 3/4" x 1/2" | DFV034012 ● | 16 | 10 | 400 | 1,20 |
| 1" x 3/4" | DFV100034 ● | 16 | 10 | 280 | 1,47 |
| 1 1/4" x 1" | DFV114100 ● | 16 | 10 | 160 | 1,75 |
| 1 1/2" x 1 1/4" | DFV112114 ● | 16 | 10 | 100 | 2,07 |
| 2" x 1 1/2" | DFV200112 | 16 | - | 60 | 3,14 |

Reducción roscada corta.
M-H roscar.



KIFV

| dm x dh x Rm | Ref. | PN | Pack | U/ | € |
|------------------|--------------|----|------|-----|-------------|
| 16 x 12 x 3/8" | KIFV16012038 | 16 | 10 | 700 | 2,19 |
| 20 x 16 x 3/4" | KIFV20016038 | 16 | 10 | 700 | 0,75 |
| 20 x 16 x 1/2" | KIFV20016012 | 16 | 10 | 700 | 0,75 |
| 25 x 20 x 1/2" | KIFV25020012 | 16 | 10 | 350 | 0,89 |
| 25 x 20 x 3/4" | KIFV25020034 | 16 | 10 | 300 | 0,89 |
| 32 x 25 x 1/2" | KIFV32025012 | 16 | 10 | 220 | 0,99 |
| 32 x 25 x 3/4" | KIFV32025034 | 16 | 10 | 200 | 0,99 |
| 32 x 25 x 1" | KIFV32025100 | 16 | 10 | 180 | 0,99 |
| 40 x 32 x 3/4" | KIFV40032034 | 16 | 10 | 120 | 1,34 |
| 40 x 32 x 1" | KIFV40032100 | 16 | 10 | 120 | 1,34 |
| 40 x 32 x 1 1/4" | KIFV40032114 | 16 | 10 | 100 | 1,34 |
| 50 x 40 x 1" | KIFV50040100 | 16 | 10 | 100 | 1,72 |
| 50 x 40 x 1 1/4" | KIFV50040114 | 16 | 10 | 100 | 1,72 |
| 50 x 40 x 1 1/2" | KIFV50040112 | 16 | 10 | 100 | 1,70 |

Terminal rosca macho.

M/H encolar - M roscar



NFV

| Rm | Ref. | PN | Pack | U/ | € |
|-----------|--------|----|------|-----|--------------|
| 3/8" | NFV038 | 16 | 10 | 800 | 0,89 |
| 1/2" | NFV012 | 16 | 10 | 500 | 0,94 |
| 3/4" | NFV034 | 16 | 10 | 260 | 1,10 |
| 1" | NFV100 | 16 | 10 | 160 | 1,34 |
| 1 1/4" | NFV114 | 16 | 10 | 80 | 1,65 |
| 1 1/2" | NFV112 | 16 | 10 | 70 | 2,17 |
| 2" | NFV200 | 16 | - | 30 | 2,77 |
| 2 1/2" A) | NFV212 | 16 | - | 24 | 4,89 |
| 3" A) | NFV300 | 16 | - | 16 | 7,64 |
| 4" A) | NFV400 | 16 | - | 6 | 17,99 |

Machón doble rosca.

A) Factor de seguridad reducido

M-M roscar.



RFV

| Rm x Rh | Ref. | PN | Pack | U/ | € |
|-----------------|-----------|----|------|-----|--------------|
| 1/2" x 3/8" | RFV012038 | 16 | 10 | 500 | 1,29 |
| 3/4" x 3/8" | RFV034038 | 16 | 10 | 400 | 1,41 |
| 3/4" x 1/2" | RFV034012 | 16 | 10 | 320 | 1,39 |
| 1" x 3/8" | RFV100038 | 16 | 10 | 240 | 1,67 |
| 1" x 1/2" | RFV100012 | 16 | 10 | 200 | 1,57 |
| 1" x 3/4" | RFV100034 | 16 | 10 | 200 | 1,57 |
| 1 1/4" x 1/2" | RFV114012 | 16 | 10 | 100 | 1,99 |
| 1 1/4" x 3/4" | RFV114034 | 16 | 10 | 80 | 1,99 |
| 1 1/4" x 1" | RFV114100 | 16 | 10 | 80 | 1,94 |
| 1 1/2" x 1/2" | RFV112012 | 16 | 10 | 80 | 2,25 |
| 1 1/2" x 3/4" | RFV112034 | 16 | 10 | 80 | 2,27 |
| 1 1/2" x 1" | RFV112100 | 16 | 10 | 80 | 2,25 |
| 1 1/2" x 1 1/4" | RFV112114 | 16 | 10 | 80 | 2,25 |
| 2" x 3/4" | RFV200034 | 16 | - | 50 | 3,35 |
| 2" x 1" | RFV200100 | 16 | - | 40 | 3,35 |
| 2" x 1 1/4" | RFV200114 | 16 | - | 40 | 3,40 |
| 2" x 1 1/2" | RFV200112 | 16 | - | 40 | 3,29 |
| 2 1/2" x 2" | RFV212200 | 16 | - | 36 | 4,47 |
| 3" x 2" | RFV300200 | 16 | - | 20 | 5,60 |
| 3" x 2 1/2" | RFV300212 | 16 | - | 20 | 7,77 |
| 4" x 3" | RFV400300 | 16 | - | 8 | 17,86 |

Reducción roscada.

M-H roscar

dm = diámetro macho dh = diámetro hembra

Rm = rosca macho



NRFV

| Rm x Rm | Ref. | PN | Pack | U/  | € |
|-----------|---------------------|----|------|--|--------------|
| ¾" x ½" | NRFV034012 ● | 16 | 10 | 300 | 0,97 |
| 1" x ¾" | NRFV100034 ● | 16 | 10 | 200 | 1,29 |
| 1¼" x 1" | NRFV114100 ● | 16 | 10 | 120 | 1,57 |
| 1½" x 1¼" | NRFV112114 ● | 16 | 10 | 80 | 1,91 |
| 2" x 1½" | NRFV200112 ● | 16 | - | 40 | 2,41 |
| 2½" x 2" | NRFV212200 | 16 | - | 24 | 4,47 |
| 3" x 2½" | NRFV300212 | 16 | - | 16 | 7,24 |
| 4" x 3" | NRFV400300 | 16 | - | 8 | 16,66 |

Machón reducido roscado.

M-M roscar.



NRIV

| d x Rh | Ref. | Pack | U/  | € |
|----------|-------------------|------|--|-------------|
| 25 x 1" | NRIV025100 | 10 | 120 | 3,51 |
| 32 x 1¼" | NRIV032114 | 10 | 60 | 4,53 |

Adaptador M-M.

M encolar - roscar.



IFFV

| Rh x Rm | Ref. | PN | Pack | U/  | € |
|-----------|---------------------|----|------|--|--------------|
| ¾" x ½" | IFFV034012 ● | 16 | 10 | 280 | 1,39 |
| 1" x ½" | IFFV100012 | 16 | 10 | 140 | 5,65 |
| 1" x ¾" | IFFV100034 | 16 | 10 | 140 | 1,62 |
| 1¼" x 1" | IFFV114100 | 16 | 10 | 80 | 1,94 |
| 1½" x 1¼" | IFFV112114 | 16 | 10 | 40 | 2,33 |
| 2" x 1½" | IFFV200112 | 16 | - | 30 | 3,11 |
| 2½" x 2" | IFFV212200 | 16 | - | 20 | 20,58 |
| 3" x 2½" | IFFV300212 | 16 | - | 16 | 12,19 |
| 4" x 3" | IFFV400300 | 16 | - | 8 | 60,13 |

Reducción roscada.

H-M roscar.



JFV

| Rh | Ref. | PN | Pack | U/  | € |
|-----|---------------|----|------|--|------------------|
| ½" | JFV012 | 16 | 25 | 1.000 | 6,75 |
| ¾" | JFV034 | 16 | 25 | 750 | 7,19 |
| 1" | JFV100 | 16 | 25 | 400 | 7,84 |
| 1¼" | JFV114 | 16 | 10 | 300 | 8,63 |
| 1½" | JFV112 | 16 | 10 | 200 | Consultar |
| 2" | JFV200 | 16 | 10 | 120 | Consultar |

Tuerca fina.

H roscar. Para adaptador depósito LIV y LIFV.

**BIV**

| d | Ref. | PN | Pack | U/ | € EPDM |
|-----|----------------|----|------|-----|--------------|
| 16 | BIV016E | 16 | 10 | 300 | 2,14 |
| 20 | BIV020E | 16 | 10 | 180 | 2,09 |
| 25 | BIV025E | 16 | 10 | 100 | 2,41 |
| 32 | BIV032E | 16 | 10 | 70 | 3,43 |
| 40 | BIV040E | 16 | 10 | 40 | 4,13 |
| 50 | BIV050E | 16 | 10 | 90 | 5,05 |
| 63 | BIV063E | 16 | 5 | 45 | 7,37 |
| 75 | BIV075E | 10 | - | 28 | 21,39 |
| 90 | BIV090E | 10 | - | 22 | 28,29 |
| 110 | BIV110E | 10 | - | 12 | 41,40 |

Unión 3 piezas encolar.
H-H encolar. Junta en EPDM.

Para recambios consultar
el apartado "Recambios"
de esta misma tarifa

**BIFV**

| d x Rh | Ref. | PN | Pack | U/ | € EPDM |
|-------------|--------------------|----|------|-----|--------------|
| 16 x 3/8" | BIFV016038E | 16 | 10 | 300 | 2,41 |
| 20 x 1/2" | BIFV020012E | 16 | 10 | 180 | 2,46 |
| 25 x 3/4" | BIFV025034E | 16 | 10 | 100 | 2,88 |
| 32 x 1" | BIFV032100E | 16 | 10 | 60 | 3,87 |
| 40 x 1 1/4" | BIFV040114E | 16 | 10 | 40 | 4,87 |
| 50 x 1 1/2" | BIFV050112E | 16 | 10 | 90 | 5,83 |
| 63 x 2" | BIFV063200E | 16 | 5 | 60 | 8,50 |
| 75 x 2 1/2" | BIFV075212E | 10 | - | 28 | 23,75 |
| 90 x 3" | BIFV090300E | 10 | - | 22 | 30,31 |
| 110 x 4" | BIFV110400E | 10 | - | 12 | 48,15 |

Unión 3 piezas mixto.
H-H encolar - rosca. Junta en EPDM.

Para recambios consultar
el apartado "Recambios"
de esta misma tarifa

**BIRV**

| d x Rm | Ref. | PN | Pack | U/ | € EPDM |
|---------------|--------------------|----|------|----|--------------|
| 20 x 1/2" * | BIRV020012E | 16 | - | 25 | 3,09 |
| 25 x 3/4" * | BIRV025034E | 16 | - | 30 | 3,43 |
| 32 x 1" * | BIRV032100E | 16 | - | 50 | 4,42 |
| 40 x 1 1/4" * | BIRV040114E | 16 | - | 36 | 5,13 |
| 50 x 1 1/2" * | BIRV050112E | 16 | 10 | 80 | 6,12 |
| 50 x 2" * | BIRV050200E | 16 | 10 | 80 | 9,26 |
| 63 x 2" * | BIRV063200E | 16 | 5 | 35 | 8,48 |
| 75 x 2 1/2" * | BIRV075212E | 16 | - | 12 | 25,92 |
| 90 x 3" * | BIRV090300E | 16 | - | 18 | 33,95 |

Unión 3 piezas mixto.
H-M encolar - rosca. Junta en EPDM.

Para recambios consultar
el apartado "Recambios"
de esta misma tarifa

**BFV**

| Rh | Ref. | PN | Pack | U/ | € EPDM |
|-----------|-------------------|----|------|-----|--------------|
| 3/8" | BFV038E | 16 | 10 | 300 | 2,74 |
| 1/2" | BFV012E | 16 | 10 | 180 | 2,96 |
| 3/4" | BFV034E | 16 | 10 | 100 | 3,48 |
| 1" | BFV100E | 16 | 10 | 60 | 4,65 |
| 1 1/4" | BFV114E | 16 | 10 | 40 | 5,83 |
| 1 1/2" | BFV112E | 16 | 10 | 90 | 6,87 |
| 2" | BFV200E | 16 | 5 | 60 | 9,78 |
| 2 1/2" ** | 1RBO275000 | 10 | - | 15 | 42,84 |
| 3" ** | 1RBO290000 | 6 | - | 12 | 73,27 |
| 4" ** | 1RBO211000 | 6 | - | 12 | 83,41 |

Unión 3 piezas roscado.
H-H rosca. Junta en EPDM.

Para recambios consultar
el apartado "Recambios"
de esta misma tarifa

**BIFOV**

| d x Rh | Ref. | PN | Pack | U/ | € EPDM |
|-------------|---------------------|----|------|-----|--------------|
| 16 x 3/8" | BIFOV016038E | 16 | 50 | 100 | 8,86 |
| 20 x 1/2" | BIFOV020012E | 16 | 40 | 80 | 11,49 |
| 25 x 3/4" | BIFOV025034E | 16 | 20 | 40 | 14,65 |
| 32 x 1" | BIFOV032100E | 16 | 14 | 28 | 18,41 |
| 40 x 1 1/4" | BIFOV040114E | 16 | 8 | 16 | 25,89 |
| 50 x 1 1/2" | BIFOV050112E | 16 | 4 | 8 | 32,32 |
| 63 x 2" | BIFOV063200E | 16 | - | 12 | 52,62 |

Unión 3 piezas mixto PVC-U / Latón.
H-H encolar - rosca latón. Junta en EPDM.

Para recambios consultar
el apartado "Recambios"
de esta misma tarifa

**BIROV**

| d x Rm | Ref. | PN | Pack | U/ | € EPDM |
|-------------|---------------------|----|------|-----|--------------|
| 16 x 3/8" | BIROV016038E | 16 | 50 | 100 | 10,65 |
| 20 x 1/2" | BIROV020012E | 16 | 35 | 70 | 12,39 |
| 25 x 3/4" | BIROV025034E | 16 | 15 | 30 | 16,24 |
| 32 x 1" | BIROV032100E | 16 | 12 | 24 | 20,87 |
| 40 x 1 1/4" | BIROV040114E | 16 | 8 | 16 | 30,28 |
| 50 x 1 1/2" | BIROV050112E | 16 | 4 | 8 | 36,09 |
| 63 x 2" | BIROV063200E | 16 | - | 10 | 62,40 |

Unión 3 piezas mixto PVC-U / Latón.
H-M encolar - rosca latón. Junta en EPDM.

Para recambios consultar
el apartado "Recambios"
de esta misma tarifa

**BIFXV**

| d x Rh | Ref. | PN | Pack | € EPDM | € FKM |
|-------------|--------------|----|------|--------|-------|
| 16 x 3/8" | BIFXV016038E | 16 | 50 | 30,92 | 32,79 |
| 20 x 1/2" | BIFXV020012E | 16 | 40 | 33,01 | 35,00 |
| 25 x 3/4" | BIFXV025034E | 16 | 20 | 37,84 | 39,65 |
| 32 x 1" | BIFXV032100E | 16 | 14 | 43,63 | 45,98 |
| 40 x 1 1/4" | BIFXV040114E | 16 | 8 | 61,83 | 64,03 |
| 50 x 1 1/2" | BIFXV050112E | 16 | 4 | 68,13 | 72,10 |
| 63 x 2" | BIFXV063200E | 16 | - | 86,67 | 90,68 |

Unión 3 piezas mixto
PVC-U / Inox A316L.
H-H encolar - roscar inox.
Junta en EPDM o FKM.

Código en FKM termina en "F"
en lugar de "E"
Para recambios consultar
el apartado "Recambios"
de esta misma tarifa

**BIRXV**

| d x Rm | Ref. | PN | Pack | € EPDM | € FKM |
|-------------|--------------|----|------|--------|--------|
| 16 x 3/8" | BIRXV016038E | 16 | 50 | 33,16 | 34,86 |
| 20 x 1/2" | BIRXV020012E | 16 | 35 | 35,13 | 36,95 |
| 25 x 3/4" | BIRXV025034E | 16 | 15 | 39,51 | 41,22 |
| 32 x 1" | BIRXV032100E | 16 | 12 | 44,56 | 47,21 |
| 40 x 1 1/4" | BIRXV040114E | 16 | 8 | 61,83 | 66,43 |
| 50 x 1 1/2" | BIRXV050112E | 16 | 4 | 73,44 | 77,05 |
| 63 x 2" | BIRXV063200E | 16 | - | 101,43 | 110,73 |

Unión 3 piezas mixto
PVC-U / Inox A316L.
H-M encolar - roscar inox.
Junta en EPDM o FKM.

Código en FKM termina en "F"
en lugar de "E"
Para recambios consultar
el apartado "Recambios"
de esta misma tarifa

**ADV**

| Rh x P1 x P2 | Ref. | PN | Pack | U/ | € EPDM |
|------------------|--------------|----|------|-----|--------|
| 1/2" x 12 x 14 | ADV012012014 | 16 | 5 | 300 | 1,89 |
| 3/4" x 16 x 18 | ADV034016018 | 16 | 5 | 200 | 2,31 |
| 1" x 20 x 22 | ADV100020022 | 16 | 5 | 160 | 2,61 |
| 1 1/4" x 25 x 27 | ADV114025027 | 16 | 5 | 80 | 2,98 |
| 1 1/2" x 30 x 32 | ADV112030032 | 16 | 5 | 50 | 3,85 |
| 2" x 40 x 42 | ADV200040042 | 16 | 5 | 30 | 3,76 |
| 2" x 50 x 52 | ADV200050052 | 16 | 5 | 25 | 4,63 |
| 2 1/4" x 50 x 52 | ADV214050052 | 16 | 5 | 20 | 11,27 |
| 2 3/4" x 60 x 64 | ADV234060064 | 16 | 3 | 21 | 5,55 |

Espiga con tuerca.
H-M roscar - presión. Junta en EPDM.

**ADV-J**

| R x P1 x P2 | Ref. | € EPDM |
|------------------|----------|--------|
| 1/2" x 12 x 14 | GP1210E | 0,39 |
| 3/4" x 16 x 18 | GP0193E | 0,45 |
| 1" x 20 x 22 | GP1212E | 0,45 |
| 1 1/4" x 25 x 27 | QHVX025E | 0,73 |
| 1 1/2" x 30 x 32 | GP0196E | 0,63 |
| 2" x 40 x 42 | GP0197E | 0,89 |
| 2" x 50 x 52 | GP0197E | 0,89 |
| 2 1/4" x 50 x 52 | GP0198E | 1,15 |
| 2 3/4" x 60 x 64 | QHVX050E | 1,54 |
| 3 3/4" x 60 x 64 | GPO0199E | 2,79 |

Junta plana EPDM
Para espiga con tuerca ADV

**AFV**

| d x P2 x P1 | Ref. | PN | Pack | U/ | € EPDM |
|--------------|--------------|----|------|-------|--------|
| 12 x 14 x 12 | AIV012014012 | 16 | 10 | 1.000 | 0,68 |
| 16 x 18 x 16 | AIV016018016 | 16 | 10 | 600 | 0,68 |
| 20 x 22 x 20 | AIV020022020 | 16 | 10 | 500 | 0,87 |
| 25 x 27 x 25 | AIV025027025 | 16 | 10 | 200 | 1,05 |
| 32 x 32 x 30 | AIV032032030 | 16 | 10 | 100 | 1,31 |
| 40 x 42 x 40 | AIV040042040 | 16 | 5 | 100 | 1,54 |
| 50 x 52 x 50 | AIV050052050 | 16 | 5 | 40 | 2,19 |
| 63 x 64 x 60 | AIV063064060 | 16 | - | 40 | 2,79 |

Espiga encolar macho.
M-M encolar - presión.

**AFV**

| Rm x P1 x P2 | Ref. | PN | Pack | U/ | € |
|------------------|--------------|----|------|-------|------|
| 1/4" x 12 x 14 | AFV014012014 | 16 | 10 | 1.000 | 0,68 |
| 3/8" x 16 x 18 | AFV038016018 | 16 | 10 | 600 | 0,65 |
| 1/2" x 20 x 22 | AFV012020022 | 16 | 10 | 300 | 0,87 |
| 3/4" x 25 x 27 | AFV034025027 | 16 | 10 | 160 | 1,02 |
| 1" x 30 x 32 | AFV100030032 | 16 | 10 | 100 | 1,31 |
| 1 1/4" x 40 x 42 | AFV114040042 | 16 | 5 | 50 | 1,57 |
| 1 1/2" x 50 x 52 | AFV112050052 | 16 | 5 | 30 | 2,25 |
| 2" x 60 x 64 | AFV200060064 | 16 | - | 20 | 2,83 |

Espiga rosca macho.
M-M roscar - presión.



PINZA*

| d | Ref. | Pack | € |
|------|--------------|------|------|
| 16** | 1RST116000 | 10 | 0,57 |
| 20** | 1RST120000 ● | 10 | 0,52 |
| 25** | 1RST125000 ● | 10 | 0,65 |
| 32** | 1RST132000 ● | 10 | 0,75 |
| 40 | 1RST140000 ● | 10 | 1,52 |
| 50 | 1RST150000 ● | 10 | 1,91 |
| 63 | 1RST163000 ● | 10 | 2,22 |
| 75 | 1RST175000 | 10 | 2,96 |
| 90 | 1RST190000 | 10 | 3,90 |
| 110 | 1RST111000 | 10 | 4,55 |

Abrazadera para tubería PP gris.
Marca ASTORE.

** En estos diámetros
sin cierre superior



ZIKM

| d | Ref. | Pack | U/☐ | € |
|-----|-----------|------|-----|-------|
| 16 | ZIKM016 | 10 | 800 | 1,47 |
| 20 | ZIKM020 ● | 10 | 600 | 1,57 |
| 25 | ZIKM025 ● | 10 | 160 | 1,62 |
| 32 | ZIKM032 ● | 10 | 240 | 1,94 |
| 40 | ZIKM040 ● | 10 | 160 | 2,38 |
| 50 | ZIKM050 ● | 10 | 100 | 2,74 |
| 63 | ZIKM063 ● | 10 | 80 | 3,40 |
| 75 | ZIKM075 ● | - | 80 | 4,81 |
| 90 | ZIKM090 | - | 40 | 5,85 |
| 110 | ZIKM110 | - | 30 | 8,19 |
| 125 | ZIKM125 | - | 20 | 11,09 |
| 140 | ZIKM140 | - | 20 | 11,59 |
| 160 | ZIKM160 | - | 10 | 13,34 |
| 180 | ZIKM180 | - | 10 | 12,19 |

Abrazadera para tubería PP gris.



| | Ref. | U/☐ | ☐ n.º | €/Unid. |
|---------------|--------|-----|-------|---------|
| 125 ml | 035001 | 96 | A-8 | 6,28 |
| Bote 250 ml | 035008 | 24 | A-11 | 13,76 |
| Bote 500 ml | 035002 | 20 | A-8 | 19,11 |
| Bote 1.000 ml | 035003 | 12 | A-8 | 31,76 |

Adhesivo NEW GENERATION.

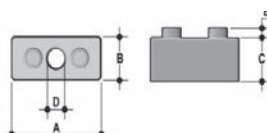

DSM

| d | Ref. | A | B | C | D | E | € |
|----|--------|----|----|------|---|---|------|
| 32 | DSM032 | 33 | 16 | 14 | 8 | 4 | 1,05 |
| 40 | DSM040 | 41 | 17 | 17 | 8 | 4 | 1,41 |
| 50 | DSM050 | 51 | 18 | 17 | 8 | 4 | 1,91 |
| 63 | DSM063 | 64 | 19 | 22,5 | 8 | 4 | 2,51 |
| 75 | DSM075 | 76 | 20 | 34,5 | 8 | 4 | 3,45 |

Soporte en PP para abrazadera ZIKM.



COBRA*

| d | Ref. | Pack | U/☐ | € |
|------|------------|------|-----|-------|
| 16** | COBRA016 ● | 10 | 50 | 0,56 |
| 20** | COBRA020 ● | 10 | 50 | 1,10 |
| 25** | COBRA025 ● | 10 | 50 | 1,38 |
| 32 | COBRA032 ● | 10 | 10 | 2,80 |
| 40 | COBRA040 ● | 10 | 10 | 3,48 |
| 50 | COBRA050 ● | 10 | 10 | 3,62 |
| 63 | COBRA063 ● | 10 | 10 | 5,58 |
| 75 | COBRA075 | 10 | 10 | 11,45 |
| 90 | COBRA090 | 10 | 10 | 13,66 |
| 110 | COBRA110 | 10 | 10 | 18,95 |
| 125 | COBRA125 | 10 | 10 | 37,39 |
| 140 | COBRA140 | - | 10 | 39,98 |
| 160 | COBRA160 | - | 10 | 45,57 |

Abrazadera para tubería PP negro.
Marca DURAPIPE

** En estos diámetros sin
cierre superior



| | Ref. | U/☐ | ☐ n.º | €/Unid. |
|-------------|--------|-----|-------|---------|
| Bote 500 ml | 035007 | 24 | A-8 | 11,46 |

Limpiador.
Desengordurante.

Lleva el agua y la energía de forma sostenible sin límites

Sistemas de conducción de fluidos

Infraestructura



Comunicaciones



Protección contra incendios



Suministro de agua



Suministro de gas e hidrógeno

Industria



Procesos industriales



Medición y control



Prefabricado industrial



Tratamiento de agua

 Seguridad  Calidad  Durabilidad  Fácil instalación

Descarga nuestro catálogo de soluciones



Grupo internacional con dos plantas de fabricación en España
Alicante Okondo
+ 45 países

Válvulas de bola 2 y 3 vías
Válvulas de mariposa
Válvulas y grifos de membrana
Válvulas de retención
Filtros inclinados



0802

Válvulas manuales en PVC-U presión

INDUSTRIA



Más información



Bloqueo de las tuercas

Para asegurar la PN y aflojes por vibraciones elevadas



Válvulas de bola

Tapón portaetiqueta

Tapón para personalizar o señalar la válvula.



Bidireccional.
Sin dirección de montaje.
Sin flecha en el cuerpo

Plena libertad y seguridad a la hora del montaje. Se pueden instalar sin necesidad de seguir la dirección de montaje. Mucho más fácil y sin riesgo de que se desmonte o bloquee la bola por la presión del fluido al desmontar el extremo que da acceso a la misma. Tampoco se bloquea la bola si nos excedemos al apretar los extremos. Por tanto el eje no sufre ni se rompe.

Tapón de protección transparente con porta etiqueta para el sistema de Labelling Easyfit (opcional)

Optional transparent service plug with tag holder for Easyfit Labelling system



Tapón de protección estándar
Grey standard service plug

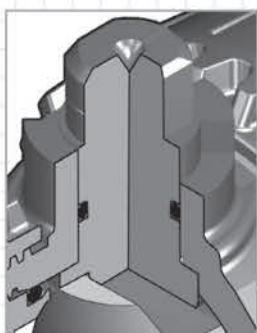

Eje y esfera de tipo flotante de alta finura superficial

High finishing stem and floating ball

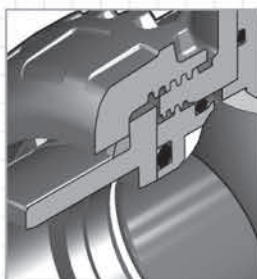

Casquillo roscado de seguridad

Safe blocked carrier



Montaje radial según norma EN 1452 "short"

True union installation according to EN 1452 "short"





Gama VEE

Maneta multifunción Easyfit
Easyfit multifunctional handle

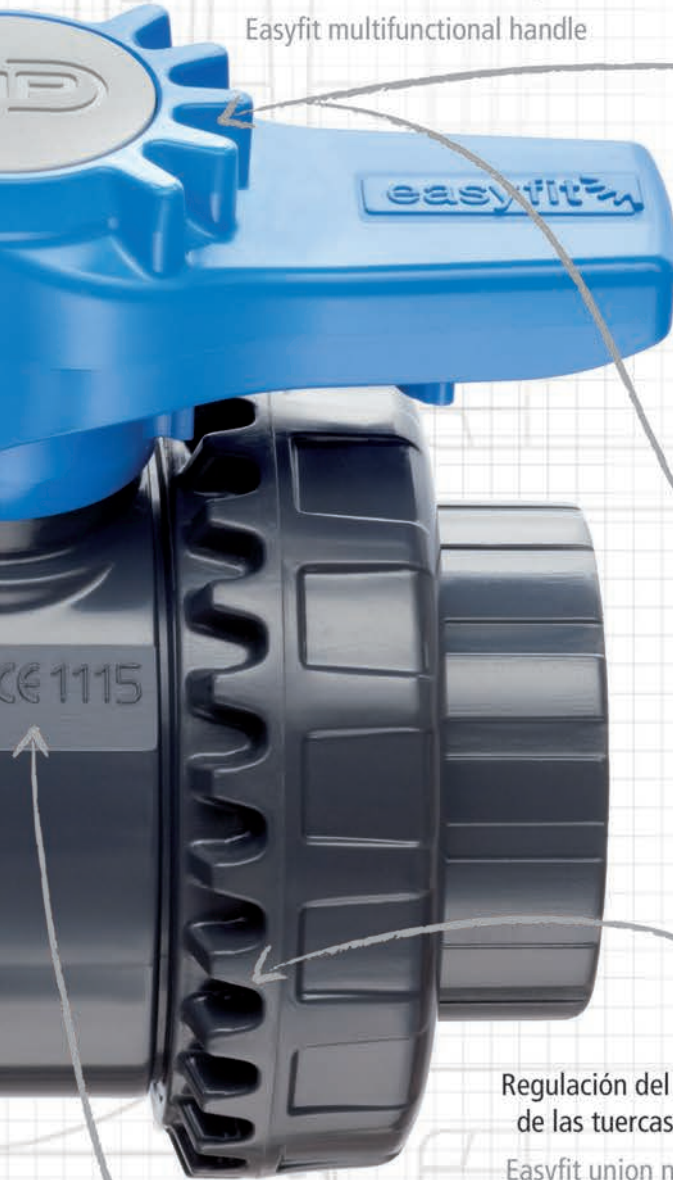

Control rotación tuercas
Union nut rotation control



Regulación casquillo estanco y bola
Ball seat carrier adjustment



Regulación del apriete
de las tuercas Easyfit
Easyfit union nut gear
tightening



Cuerpo de la válvula PN16
Certificado 97/23/CE

Valve body PN16
97/23/CE Certified



Sistema de etiquetado:

sistema completo de etiquetado que identifica la válvula según necesidades específicas.

Labelling System:

complete tagging system that allows the identification of the valve according to specific needs.



Rendimiento y seguridad:

válvula ligera y compacta con cuerpo PN16 en PVC-U K62 o PVC-C Corzan y doble junta tórica en el eje de la válvula. El acabado de gran calidad de la bola, el asiento de bola y el disco anti-fricción en PTFE situado en la base del eje minimizan las fricciones logrando un excelente funcionamiento de par de torsión.



The high surface finished ball, the PTFE ball seat and the PTFE anti-friction disc located at the base of the stem minimize the frictions achieving excellent operating torque.

Performance and safety:

light and compact valve with PN16 body in PVC-U K62 or PVC-C Corzan™ and double O-ring seal on the valve stem.

The high surface finished ball, the PTFE ball

Cerradura a prueba de manipulaciones:

la válvula está equipada con un sistema simple que evita la rotación de la maneta tanto de apertura como de cierre mediante un candado.

Fácil accionamiento:

el cuerpo de la válvula tiene una estructura integrada para fijar el kit de actuación PowerQuick, específico para la instalación de actuadores neumáticos y eléctricos.

Easy

actuation:

the valve body has an integrated structure for anchoring the special PowerQuick module, dedicated to the installation of pneumatic and electric actuators.

Tamper-proof lock:

the valve is equipped with a simple system that avoid the handle rotation both for opening and closing operations inputting a padlock.





Gama VXE

Maneta multifuncional Easyfit
Easyfit multifunctional handle

Maneta multifunción Easyfit de rápida extracción:
para usar la maneta como herramienta multifuncional para apretar las tuercas de unión y ajustar el soporte de asiento de bola se puede extraer del dedo con una simple maniobra permaneciendo firme al eje que se está maniobrando.



Easyfit Quick-release multifunctional handle:
the handle, to be used as multifunction tool for union nuts tightening and ball seat carrier adjustment can be removed with a simple operation from the hub which remains firmly coupled to the maneuvering stem.



Bisel giratorio con la maneta multifuncional Easyfit:

el uso del gancho alojado en el interior de la maneta permite crear una llave para el ajuste de las tuercas de unión que asegura un acoplamiento seguro y sólido.



Ajuste del casquillo de la bola de apoyo con la maneta multifuncional Easyfit.

Ball seat carrier adjustment with Easyfit multifunctional handle.



Union nut tightening with Easyfit multifunctional handle:
the use of the hooked insert housed inside the handle allows to realize a key for the union nuts rotation that ensures a secure and solid engagement.



Maneta multifunción
Multi functional handle



Kit de montaje para actuadores
Mounting flange

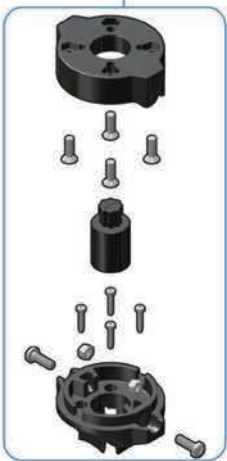

Soporte de fijación
Bracketing



Gama VKD

Válvula industrial



Conexión eje y bola
Stem-ball connection

Soporte del asiento de la bola
Safe blocked carrier

Dual Block
Dual Block

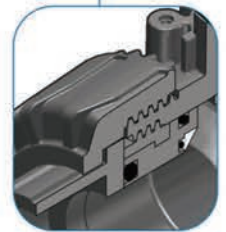

Cuerpo
Body





INDUSTRIA

Válvulas manuales de PVC-U presión

Válvulas de bola 2 vías



VEEIV

| d | Ref. | DN | PN | U/ | € EPDM |
|----|-----------|----|----|----|--------|
| 16 | VEEIV016E | 10 | 16 | 90 | 10,95 |
| 20 | VEEIV020E | 15 | 16 | 90 | 10,95 |
| 25 | VEEIV025E | 20 | 16 | 55 | 12,11 |
| 32 | VEEIV032E | 25 | 16 | 35 | 15,90 |
| 40 | VEEIV040E | 32 | 16 | 20 | 18,51 |
| 50 | VEEIV050E | 40 | 16 | 15 | 25,32 |
| 63 | VEEIV063E | 50 | 16 | 8 | 34,47 |

Válvula de bola maneta azul.

H-H encolar. Junta EPDM - Asiento PE. Bidireccional.



VEEFV

| Rh | Ref. | DN | PN | U/ | € EPDM |
|--------|-----------|----|----|----|--------|
| 3/8" | VEEFV038E | 10 | 16 | 90 | 11,51 |
| 1/2" | VEEFV012E | 15 | 16 | 90 | 11,51 |
| 3/4" | VEEFV034E | 20 | 16 | 55 | 12,69 |
| 1" | VEEFV100E | 25 | 16 | 35 | 16,84 |
| 1 1/4" | VEEFV114E | 32 | 16 | 20 | 19,77 |
| 1 1/2" | VEEFV112E | 40 | 16 | 15 | 26,99 |
| 2" | VEEFV200E | 50 | 16 | 8 | 36,64 |

Válvula de bola maneta azul.

H-H roscar. Junta EPDM - Asiento PE. Bidireccional.



VEEIV

| d | Ref. | DN | PN | U/ | € EPDM |
|-----|-----------|-----|----|----|--------|
| 75 | VEEIV075E | 65 | 16 | 2 | 102,37 |
| 90 | VEEIV090E | 80 | 16 | 2 | 139,35 |
| 110 | VEEIV110E | 100 | 16 | 1 | 249,09 |

Válvula de bola maneta azul.

H-H encolar. Junta EPDM - Asiento PE. Bidireccional.



VEEFV

| Rh | Ref. | DN | PN | U/ | € EPDM |
|--------|-----------|-----|----|----|--------|
| 2 1/2" | VEEFV212E | 65 | 16 | 2 | 107,60 |
| 3" | VEEFV300E | 80 | 16 | 2 | 144,84 |
| 4" | VEEFV400E | 100 | 16 | 1 | 262,82 |

Válvula de bola maneta azul.

H-H roscar. Junta EPDM - Asiento PE. Bidireccional.

Para recambios de las válvulas consultar el último apartado "Recambios" de esta misma tarifa.

**VXEIV**

| d | Ref. EPDM | DN | PN | U/ | € EPDM | € FKM |
|----|-----------|----|----|----|--------|-------|
| 16 | VXEIV016E | 10 | 16 | 30 | 14,07 | 16,84 |
| 20 | VXEIV020E | 15 | 16 | 30 | 14,13 | 16,89 |
| 25 | VXEIV025E | 20 | 16 | 30 | 16,69 | 20,22 |
| 32 | VXEIV032E | 25 | 16 | 20 | 19,61 | 23,75 |
| 40 | VXEIV040E | 32 | 16 | 14 | 25,53 | 30,18 |
| 50 | VXEIV050E | 40 | 16 | 6 | 31,41 | 36,99 |
| 63 | VXEIV063E | 50 | 16 | 6 | 41,82 | 53,59 |

Válvula de bola maneta naranja.

H-H encolar. Asiento PTFE (teflón).

Bidireccional.

Código en FKM termina en "F" en lugar de "E"

**VXEFV**

| Rh | Ref. EPDM | DN | PN | U/ | € EPDM | € FKM |
|--------|-----------|----|----|----|--------|-------|
| 3/8" | VXEFV038E | 10 | 16 | 30 | 15,48 | 18,46 |
| 1/2" | VXEFV012E | 15 | 16 | 30 | 15,53 | 18,46 |
| 3/4" | VXEFV034E | 20 | 16 | 30 | 18,33 | 21,89 |
| 1" | VXEFV100E | 25 | 16 | 20 | 21,99 | 26,10 |
| 1 1/4" | VXEFV114E | 32 | 16 | 14 | 28,59 | 33,21 |
| 1 1/2" | VXEFV112E | 40 | 16 | 6 | 34,55 | 40,10 |
| 2" | VXEFV200E | 50 | 16 | 6 | 51,03 | 62,77 |

Válvula de bola maneta naranja.

H-H roscar. Asiento PTFE (teflón).

Bidireccional.

Código en FKM termina en "F" en lugar de "E"

**VXEIV**

| d | Ref. EPDM | DN | PN | € EPDM | € FKM |
|-----|-----------|-----|----|--------|--------|
| 75 | VXEIV075E | 65 | 16 | 110,76 | 121,85 |
| 90 | VXEIV090E | 80 | 16 | 150,83 | 165,92 |
| 110 | VXEIV110E | 100 | 16 | 309,85 | 340,81 |

Válvula de bola maneta naranja.

H-H encolar. Asiento PTFE (teflón).

Bidireccional.

Código en FKM termina en "F" en lugar de "E"

**VXEFV**

| Rh | Ref. EPDM | DN | PN | € EPDM | € FKM |
|--------|-----------|-----|----|--------|--------|
| 2 1/2" | VXEFV212E | 65 | 16 | 124,34 | 240,62 |
| 3" | VXEFV300E | 80 | 16 | 164,72 | 299,70 |
| 4" | VXEFV400E | 100 | 16 | 346,10 | 381,56 |

Válvula de bola maneta naranja.

H-H roscar. Asiento PTFE (teflón).

Bidireccional.

Código en FKM termina en "F" en lugar de "E"

Para recambios de las válvulas consultar el último apartado "Recambios" de esta misma tarifa.

**VPE***

| Rh x d | Ref. EPDM | PN | U/ | € EPDM |
|-------------|-----------|----|-----|--------|
| 3/8" x 16 | VPE038016 | 16 | 120 | 18,07 |
| 1/2" x 20 | VPE012020 | 16 | 100 | 18,07 |
| 3/4" x 25 | VPE034025 | 16 | 60 | 20,82 |
| 1" x 32 | VPE100032 | 16 | 40 | 23,01 |
| 1 1/4" x 40 | VPE114040 | 16 | 20 | 35,55 |
| 1 1/2" x 50 | VPE112050 | 16 | 15 | 40,85 |
| 2" x 63 | VPE200063 | 16 | 8 | 61,65 |

Válvula de bola.

PVC roscar hembra. Enlace PE H.

**VKDFV**

| Rh | Ref. EPDM | DN | PN | € EPDM | € FKM |
|--------|-----------|----|----|--------|--------|
| 3/8" | VKDFV038E | 10 | 16 | 42,79 | 51,75 |
| 1/2" | VKDFV012E | 15 | 16 | 44,83 | 53,64 |
| 3/4" | VKDFV034E | 20 | 16 | 53,64 | 62,22 |
| 1" | VKDFV100E | 25 | 16 | 65,85 | 82,94 |
| 1 1/4" | VKDFV114E | 32 | 16 | 83,67 | 97,79 |
| 1 1/2" | VKDFV112E | 40 | 16 | 109,69 | 127,53 |
| 2" | VKDFV200E | 50 | 16 | 138,15 | 173,55 |

Válvula de bola DUAL BLOCK®.

H-H roscar. Asiento PTFE (teflón).

Bidireccional.

Código en FKM termina en "F" en lugar de "E"

**VKDIV**

| d | Ref. EPDM | DN | PN | € EPDM | € FKM |
|----|-----------|----|----|--------|--------|
| 16 | VKDIV016E | 10 | 16 | 39,68 | 48,09 |
| 20 | VKDIV020E | 15 | 16 | 41,30 | 49,41 |
| 25 | VKDIV025E | 20 | 16 | 48,86 | 59,24 |
| 32 | VKDIV032E | 25 | 16 | 60,83 | 73,57 |
| 40 | VKDIV040E | 32 | 16 | 75,77 | 89,61 |
| 50 | VKDIV050E | 40 | 16 | 97,65 | 114,97 |
| 63 | VKDIV063E | 50 | 16 | 121,61 | 155,79 |

Válvula de bola DUAL BLOCK®.

H-H encolar. Asiento PTFE (teflón).

Bidireccional.

Código en FKM termina en "F" en lugar de "E"

**VKDFV**

| Rh | Ref. EPDM | DN | PN | € EPDM | € FKM |
|--------|-----------|-----|----|--------|--------|
| 2 1/2" | VKDFV212E | 65 | 16 | 395,63 | 467,81 |
| 3" | VKDFV300E | 80 | 16 | 504,03 | 592,10 |
| 4" | VKDFV400E | 100 | 16 | 566,83 | 688,32 |

Válvula de bola DUAL BLOCK®.

H-H roscar. Asiento PTFE (teflón).

Bidireccional.

Código en FKM termina en "F" en lugar de "E"

**VKDIV**

| d | Ref. EPDM | DN | PN | € EPDM | € FKM |
|-----|-----------|-----|----|--------|--------|
| 75 | VKDIV075E | 65 | 16 | 366,31 | 438,50 |
| 90 | VKDIV090E | 80 | 16 | 466,71 | 554,75 |
| 110 | VKDIV110E | 100 | 16 | 524,83 | 646,31 |

Válvula de bola DUAL BLOCK®.

H-H encolar. Asiento PTFE (teflón).

Bidireccional.

Código en FKM termina en "F" en lugar de "E"



| d | Ref. | DN | PN | € |
|-----|--------|-----|----|--------|
| 140 | 052322 | 125 | 10 | 753,48 |

Válvula de bola PASO TOTAL con bridas

Sugerencia tornillería M6x100

Para recambios de las válvulas consultar el último apartado "Recambios" de esta misma tarifa.

**VKDDV**

| d | Ref. EPDM | DN | PN | € EPDM | € FKM |
|----|-----------|----|----|--------|--------|
| 16 | VKDDV016E | 10 | 16 | 39,68 | 48,09 |
| 20 | VKDDV020E | 15 | 16 | 41,30 | 49,41 |
| 25 | VKDDV025E | 20 | 16 | 48,86 | 59,24 |
| 32 | VKDDV032E | 25 | 16 | 60,83 | 73,57 |
| 40 | VKDDV040E | 32 | 16 | 75,77 | 89,61 |
| 50 | VKDDV050E | 40 | 16 | 97,65 | 114,97 |
| 63 | VKDDV063E | 50 | 16 | 121,61 | 155,79 |

Válvula de bola DUAL BLOCK®.
M-M encolar. Asiento PTFE (teflón).
Bidireccional.

Código en FKM termina en "F"
en lugar de "E"

**VKDBEV**

| d | Ref. EPDM | DN | PN | € EPDM | € FKM |
|----|------------|----|----|--------|--------|
| 20 | VKDBEV020E | 15 | 16 | 49,83 | 68,26 |
| 25 | VKDBEV025E | 20 | 16 | 50,11 | 65,15 |
| 32 | VKDBEV032E | 25 | 16 | 57,82 | 77,67 |
| 40 | VKDBEV040E | 32 | 16 | 74,88 | 98,05 |
| 50 | VKDBEV050E | 40 | 16 | 92,45 | 120,63 |
| 63 | VKDBEV063E | 50 | 16 | 121,33 | 161,61 |

Válvula de bola DUAL BLOCK®.
Long spigot PE100 SDR11.
Asiento PTFE (teflón). Bidireccional.

Código en FKM termina en "F"
en lugar de "E"

**VKDDV**

| d | Ref. EPDM | DN | PN | € EPDM | € FKM |
|-----|-----------|-----|----|--------|--------|
| 75 | VKDDV075E | 65 | 16 | 366,31 | 438,50 |
| 90 | VKDDV090E | 80 | 16 | 466,71 | 554,75 |
| 110 | VKDDV110E | 100 | 16 | 524,83 | 646,31 |

Válvula de bola DUAL BLOCK®.
M-M encolar. Asiento PTFE (teflón).
Bidireccional.

Código en FKM termina en "F"
en lugar de "E"

**VKDBEV**

| d | Ref. EPDM | DN | PN | € EPDM | € FKM |
|-----|------------|-----|----|--------|--------|
| 75 | VKDBEV075E | 65 | 16 | 402,95 | 475,17 |
| 90 | VKDBEV090E | 80 | 16 | 513,38 | 601,43 |
| 110 | VKDBEV110E | 100 | 16 | 577,29 | 698,80 |

Válvula de bola DUAL BLOCK®.
Long spigot PE100 SDR11.
Asiento PTFE (teflón). Bidireccional.

Código en FKM termina en "F"
en lugar de "E"

**VKROV**

| d | Ref. EPDM | DN | PN | € EPDM | € FKM |
|----|-----------|----|----|--------|--------|
| 20 | VKROV020E | 15 | 16 | 197,54 | 197,54 |
| 25 | VKROV025E | 20 | 16 | 222,04 | 222,04 |
| 32 | VKROV032E | 25 | 16 | 261,91 | 261,91 |
| 40 | VKROV040E | 32 | 16 | 288,34 | 288,34 |
| 50 | VKROV050E | 40 | 16 | 365,86 | 365,86 |
| 63 | VKROV063E | 50 | 16 | 399,05 | 399,05 |

Válvula de bola REGULACIÓN
DUALBLOCK®.
Con bridas DIN 2501.

Asiento PTFE (teflón). Bidireccional.

Código en FKM termina en "F"
en lugar de "E"

**VKROAV**

| d | Ref. EPDM | DN | PN | € EPDM | € FKM |
|-----|------------|----|----|--------|--------|
| ½" | VKROAV012E | 15 | 16 | 197,54 | 197,54 |
| ¾" | VKROAV034E | 20 | 16 | 222,04 | 222,04 |
| 1" | VKROAV100E | 25 | 16 | 261,91 | 261,91 |
| 1¼" | VKROAV114E | 32 | 16 | 288,34 | 288,34 |
| 1½" | VKROAV112E | 40 | 16 | 365,86 | 365,86 |
| 2" | VKROAV200E | 50 | 16 | 399,05 | 399,05 |

Válvula de bola REGULACIÓN
DUALBLOCK®.
Con bridas ANSI 150 lbs.

Asiento PTFE (teflón). Bidireccional.

Código en FKM termina en "F"
en lugar de "E"

Para recambios de las válvulas consultar el último apartado "Recambios" de esta misma tarifa.



VKDOV

| d | Ref. EPDM | DN | PN | € EPDM | € FKM |
|----|-----------|----|----|--------|--------|
| 20 | VKDOV020E | 15 | 16 | 117,62 | 122,01 |
| 25 | VKDOV025E | 20 | 16 | 137,88 | 142,95 |
| 32 | VKDOV032E | 25 | 16 | 194,03 | 153,92 |
| 40 | VKDOV040E | 32 | 16 | 182,53 | 190,47 |
| 50 | VKDOV050E | 40 | 16 | 202,80 | 219,40 |
| 63 | VKDOV063E | 50 | 16 | 234,18 | 258,21 |

Válvula de bola DUAL BLOCK®.
Con brida loca. Asiento PTFE (teflón).
Bidireccional.

Código en FKM termina en "F"
en lugar de "E"
Versión con bridas ANSI 150 lbs
al mismo precio



VKRIV

| d | Ref. EPDM | DN | PN | € EPDM | € FKM |
|----|-----------|----|----|--------|--------|
| 16 | VKRIV016E | 10 | 16 | 161,79 | 170,21 |
| 20 | VKRIV020E | 15 | 16 | 163,41 | 171,51 |
| 25 | VKRIV025E | 20 | 16 | 183,57 | 193,95 |
| 32 | VKRIV032E | 25 | 16 | 220,40 | 233,08 |
| 40 | VKRIV040E | 32 | 16 | 232,77 | 246,63 |
| 50 | VKRIV050E | 40 | 16 | 304,66 | 321,95 |
| 63 | VKRIV063E | 50 | 16 | 317,30 | 351,48 |

Válvula de bola REGULACIÓN
DUALBLOCK®.

H-H encolar. Asiento PTFE (teflón).
Bidireccional.

Código en FKM termina en "F"
en lugar de "E"



VKDOV

| d | Ref. EPDM | DN | PN | € EPDM | € FKM |
|-----|-----------|-----|----|--------|--------|
| 75 | VKDOV075E | 65 | 16 | 558,31 | 599,21 |
| 90 | VKDOV090E | 80 | 16 | 702,96 | 777,87 |
| 110 | VKDOV110E | 100 | 16 | 884,13 | 980,45 |

Válvula de bola DUAL BLOCK®.
Con brida loca. Asiento PTFE (teflón).
Bidireccional. DIN y ANSI 150 Lbs.

Código en FKM termina en "F"
en lugar de "E"



VKRFV

| Rh | Ref. EPDM | DN | PN | € EPDM | € FKM |
|--------|-----------|----|----|--------|--------|
| 3/8" | VKRFV038E | 10 | 16 | 164,92 | 164,92 |
| 1/2" | VKRFV012E | 15 | 16 | 166,94 | 166,94 |
| 3/4" | VKRFV034E | 20 | 16 | 188,36 | 188,36 |
| 1" | VKRFV100E | 25 | 16 | 225,37 | 225,37 |
| 1 1/4" | VKRFV114E | 32 | 16 | 240,72 | 240,72 |
| 1 1/2" | VKRFV112E | 40 | 16 | 316,67 | 316,67 |
| 2" | VKRFV200E | 50 | 16 | 333,86 | 333,88 |

Válvula de bola REGULACIÓN
DUALBLOCK®.

H-H roscar. Asiento PTFE (teflón).
Bidireccional.

Código en FKM termina en "F"
en lugar de "E"



VKRDV

| d | Ref. EPDM | DN | PN | € EPDM | € FKM |
|----|-----------|----|----|--------|--------|
| 16 | VKRDV016E | 10 | 16 | 161,79 | 161,79 |
| 20 | VKRDV020E | 15 | 16 | 163,41 | 163,41 |
| 25 | VKRDV025E | 20 | 16 | 183,57 | 183,57 |
| 32 | VKRDV032E | 25 | 16 | 220,40 | 220,40 |
| 40 | VKRDV040E | 32 | 16 | 232,77 | 232,77 |
| 50 | VKRDV050E | 40 | 16 | 304,66 | 304,66 |
| 63 | VKRDV063E | 50 | 16 | 317,30 | 317,30 |

Válvula de bola REGULACIÓN
DUALBLOCK®.

M-M encolar. Asiento PTFE (teflón).
Bidireccional.

Código en FKM termina en "F"
en lugar de "E"



VKRBEV

| d | Ref. EPDM | DN | PN | € EPDM | € FKM |
|----|------------|----|----|--------|--------|
| 20 | VKRBEV020E | 15 | 16 | 171,96 | 171,96 |
| 25 | VKRBEV025E | 20 | 16 | 184,80 | 184,80 |
| 32 | VKRBEV032E | 25 | 16 | 217,34 | 217,34 |
| 40 | VKRBEV040E | 32 | 16 | 231,93 | 231,93 |
| 50 | VKRBEV050E | 40 | 16 | 299,43 | 299,43 |
| 63 | VKRBEV063E | 50 | 16 | 317,07 | 317,07 |

Válvula de bola REGULACIÓN
DUALBLOCK®.

Long spigot PE100 SDR11.
Asiento PTFE (teflón). Bidireccional.

Código en FKM termina en "F"
en lugar de "E"

Para recambios de las válvulas consultar el último apartado "Recambios" de esta misma tarifa.



INDUSTRIA

Válvulas manuales de PVC-U presión

Válvulas de bola de 3 vías

**TKDIV**

| d | Ref. EPDM | DN | PN | € EPDM | € FKM |
|----|-----------|----|----|--------|--------|
| 16 | TKDIV016E | 10 | 16 | 121,06 | 136,86 |
| 20 | TKDIV020E | 15 | 16 | 123,60 | 139,66 |
| 25 | TKDIV025E | 20 | 16 | 143,03 | 164,51 |
| 32 | TKDIV032E | 25 | 16 | 177,30 | 203,92 |
| 40 | TKDIV040E | 32 | 16 | 213,86 | 252,46 |
| 50 | TKDIV050E | 40 | 16 | 258,51 | 323,07 |
| 63 | TKDIV063E | 50 | 16 | 326,13 | 407,68 |

Válvula de bola 3 vías
DUAL BLOCK®. PASO T.

H-H-H encolar. Asiento PTFE (teflón).

Código en FKM termina en "F"
en lugar de "E"

**LKDIV**

| d | Ref. EPDM | DN | PN | € EPDM | € FKM |
|----|-----------|----|----|--------|--------|
| 16 | LKDIV016E | 10 | 16 | 133,17 | 150,51 |
| 20 | LKDIV020E | 15 | 16 | 135,93 | 153,60 |
| 25 | LKDIV025E | 20 | 16 | 157,40 | 180,93 |
| 32 | LKDIV032E | 25 | 16 | 195,09 | 224,32 |
| 40 | LKDIV040E | 32 | 16 | 235,35 | 277,73 |
| 50 | LKDIV050E | 40 | 16 | 284,31 | 355,38 |
| 63 | LKDIV063E | 50 | 16 | 358,75 | 448,43 |

Válvula de bola 3 vías
DUAL BLOCK®. PASO L.

H-H-H encolar. Asiento PTFE (teflón).

Código en FKM termina en "F"
en lugar de "E"

**TKDFV**

| Rh | Ref. EPDM | DN | PN | € EPDM | € FKM |
|--------|-----------|----|----|--------|--------|
| 3/8" | TKDFV038E | 10 | 16 | 133,17 | 148,95 |
| 1/2" | TKDFV012E | 15 | 16 | 135,93 | 152,01 |
| 3/4" | TKDFV034E | 20 | 16 | 157,40 | 178,79 |
| 1" | TKDFV100E | 25 | 16 | 195,09 | 221,63 |
| 1 1/4" | TKDFV114E | 32 | 16 | 235,35 | 273,86 |
| 1 1/2" | TKDFV112E | 40 | 16 | 284,31 | 348,99 |
| 2" | TKDFV200E | 50 | 16 | 358,75 | 440,32 |

Válvula de bola 3 vías
DUAL BLOCK®. PASO T.

H-H-H roscar. Asiento PTFE (teflón).

Código en FKM termina en "F"
en lugar de "E"

**LKDFV**

| Rh | Ref. EPDM | DN | PN | € EPDM | € FKM |
|--------|-----------|----|----|--------|--------|
| 3/8" | LKDFV038E | 10 | 16 | 145,34 | 162,65 |
| 1/2" | LKDFV012E | 15 | 16 | 148,29 | 165,97 |
| 3/4" | LKDFV034E | 20 | 16 | 171,63 | 195,21 |
| 1" | LKDFV100E | 25 | 16 | 212,76 | 242,03 |
| 1 1/4" | LKDFV114E | 32 | 16 | 256,72 | 299,13 |
| 1 1/2" | LKDFV112E | 40 | 16 | 310,18 | 381,25 |
| 2" | LKDFV200E | 50 | 16 | 391,39 | 481,05 |

Válvula de bola 3 vías
DUAL BLOCK®. PASO L.

H-H-H roscar. Asiento PTFE (teflón).

Código en FKM termina en "F"
en lugar de "E"

**TKDDV**

| d | Ref. EPDM | DN | PN | € EPDM | € FKM |
|----|-----------|----|----|--------|--------|
| 20 | TKDDV020E | 15 | 16 | 123,60 | 139,66 |
| 25 | TKDDV025E | 20 | 16 | 143,03 | 164,51 |
| 32 | TKDDV032E | 25 | 16 | 177,30 | 203,92 |
| 40 | TKDDV040E | 32 | 16 | 213,86 | 252,46 |
| 50 | TKDDV050E | 40 | 16 | 258,51 | 223,07 |
| 63 | TKDDV063E | 50 | 16 | 326,13 | 407,68 |

Válvula de bola 3 vías
DUAL BLOCK®. PASO T.

M-M-M encolar. Asiento PTFE (teflón).

Código en FKM termina en "F"
en lugar de "E"

Para recambios de las válvulas consultar el último apartado "Recambios" de esta misma tarifa.



INDUSTRIA

Válvulas manuales de PVC-U presión

Válvulas de 3 vías / Válvulas de mariposa



LKDDV

| d | Ref. EPDM | DN | PN | € EPDM | € FKM |
|----|-----------|----|----|--------|--------|
| 20 | LKDDV020E | 15 | 16 | 135,93 | 153,60 |
| 25 | LKDDV025E | 20 | 16 | 157,40 | 180,93 |
| 32 | LKDDV032E | 25 | 16 | 195,09 | 224,32 |
| 40 | LKDDV040E | 32 | 16 | 235,35 | 277,73 |
| 50 | LKDDV050E | 40 | 16 | 284,31 | 355,38 |
| 63 | LKDDV063E | 50 | 16 | 358,75 | 448,43 |

Válvula de bola 3 vías
DUAL BLOCK®. PASO L.

M-M-M encolar. Asiento PTFE (teflón).

Código en FKM termina en "F"
en lugar de "E"



SETFLOV

| d DIN | d ANSI | Ref. DIN | € DIN 2501 | € ANSI |
|-------|--------|------------|------------|--------|
| 20 | ½" | SETFLOV020 | 59,97 | 59,97 |
| 25 | ¾" | SETFLOV025 | 72,05 | 72,05 |
| 32 | 1" | SETFLOV032 | 77,07 | 77,07 |
| 40 | 1¼" | SETFLOV040 | 92,45 | 92,45 |
| 50 | 1½" | SETFLOV050 | 105,53 | 105,53 |
| 63 | 2" | SETFLOV063 | 114,32 | 114,32 |
| 75 | 2½" | SETFLOV075 | 210,27 | 210,27 |
| 90 | 3" | SETFLOV090 | 246,63 | 246,63 |
| 110 | 4" | SETFLOV110 | 297,55 | 297,55 |

Set embrizado.

Compuesto por 1 brida, 1 anillo fijación y 1 tuerca.
Para Válvulas VKD / VKR / TKD / RVU / VRU / VVU.

d. 75-90-110,
es el mismo artículo
para DIN y ANSI



FEOV/LM

| d | Ref. EPDM | DN | € EPDM | € FKM |
|-------------|------------|-----|----------|----------|
| 50 | FEOVLM050E | 40 | 133,65 | 245,37 |
| 63 | FEOVLM063E | 50 | 140,19 | 258,93 |
| 75 | FEOVLM075E | 65 | 145,34 | 262,06 |
| 90 | FEOVLM090E | 80 | 163,38 | 317,56 |
| 110 | FEOVLM110E | 100 | 187,97 | 389,04 |
| 125 (A1) | FEOVLM140E | 125 | 216,47 | 508,23 |
| 140 | FEOVLM140E | 125 | 216,47 | 508,23 |
| 160 | FEOVLM160E | 150 | 266,43 | 730,50 |
| 200 (A1) | FEOVLM225E | 200 | 428,63 | 1.029,47 |
| 225 | FEOVLM225E | 200 | 428,63 | 1.029,47 |
| (B) 250 (1) | FEOVFM280E | 250 | 1.270,87 | - |
| 280 (1) | FEOVFM280E | 250 | 1.270,87 | - |
| 315 (1) | FEOVFM315E | 300 | 1.579,64 | - |

Válvula de mariposa
"WAFER".
Con maneta.

Código en FKM termina en "F"
en lugar de "E"

(A1) A utilizar con portabridas especial
QPV FK/FE no incluido. (1) Sin maneta
(B) A utilizar con tubo D250 SDR26 (PN10)



FEOV/RM

| d | Ref. EPDM | DN | € EPDM | € FKM |
|----------|------------|-----|----------|----------|
| 75 | FEOVRM075E | 65 | 408,03 | 491,98 |
| 90 | FEOVRM090E | 80 | 424,47 | 531,27 |
| 110 | FEOVRM110E | 100 | 439,12 | 587,86 |
| 125 (A1) | FEOVRM140E | 125 | 459,18 | 676,36 |
| 140 | FEOVRM140E | 125 | 459,18 | 676,36 |
| 160 | FEOVRM160E | 150 | 495,62 | 846,15 |
| 200 (A1) | FEOVRM225E | 200 | 719,25 | 1.196,64 |
| 225 | FEOVRM225E | 200 | 719,25 | 1.196,64 |
| 250 | FEOVRM280E | 250 | 1.784,85 | - |
| 280 | FEOVRM280E | 250 | 1.784,85 | - |
| 315 | FEOVRM315E | 300 | 2.007,31 | - |

Válvula de mariposa
"WAFER".

Con volante reductor.

Código en FKM termina en "F"
en lugar de "E"

(A1) A utilizar con portabridas especial
QPV FK/FE no incluido.

Ver portabridas especial QPV FK/FE para válvulas de mariposa en el apartado
Accesorios de PVC-U de esta misma tarifa.

Para recambios de las válvulas consultar el último apartado "Recambios" de esta misma tarifa.



FKOV/FM

| d | Ref. EPDM | DN | € EPDM | € FKM |
|----------|------------|-----|----------|-----------|
| 50 | FKOVFM050E | 40 | 299,28 | 467,61 |
| 63 | FKOVFM063E | 50 | 316,88 | 495,17 |
| 75 | FKOVFM075E | 65 | 352,11 | 550,12 |
| 90 | FKOVFM090E | 80 | 382,95 | 589,74 |
| 110 | FKOVFM110E | 100 | 415,14 | 638,15 |
| 125 (A1) | FKOVFM140E | 125 | 551,61 | 853,84 |
| 140 | FKOVFM140E | 125 | 551,61 | 853,84 |
| 160 | FKOVFM160E | 150 | 610,28 | 922,76 |
| 200 (A1) | FKOVFM225E | 200 | 789,27 | 1.197,09 |
| 225 | FKOVFM225E | 200 | 789,27 | 1.197,09 |
| 250** | FKOVFM280E | 250 | 2.516,31 | 4.227,01 |
| 280** | FKOVFM280E | 250 | 2.516,31 | 4.227,01 |
| 315** | FKOVFM315E | 300 | 2.743,67 | 4.608,49 |
| 355** | FKOVFM355E | 350 | 4.654,03 | 8.535,09 |
| 400** | FKOVFM400E | 400 | 5.297,65 | 10.904,22 |

Válvula de mariposa industrial.

A EJE LIBRE.

Para actuar. Cuerpo en PPGR,
eje inoxidable y disco en PVC-U.

Código en FKM termina en "F"
en lugar de "E"

(A1) A utilizar con portabridas especial
QPV FK/FE no incluido.

** ANSI 150 lbs bajo pedido
al mismo precio.



FKOV/LM

| d | Ref. EPDM | DN | € EPDM | € FKM |
|----------|------------|-----|--------|----------|
| 50 | FKOVLM050E | 40 | 351,67 | 519,99 |
| 63 | FKOVLM063E | 50 | 372,33 | 550,57 |
| 75 | FKOVLM075E | 65 | 413,67 | 611,77 |
| 90 | FKOVLM090E | 80 | 434,20 | 641,06 |
| 110 | FKOVLM110E | 100 | 472,39 | 693,89 |
| 125 (A1) | FKOVLM140E | 125 | 627,85 | 928,62 |
| 140 | FKOVLM140E | 125 | 627,85 | 928,62 |
| 160 | FKOVLM160E | 150 | 677,78 | 971,17 |
| 200 (A1) | FKOVLM225E | 200 | 877,28 | 1.260,20 |
| 225 | FKOVLM225E | 200 | 877,28 | 1.260,20 |

Válvula de mariposa industrial.

CON MANETA.

Cuerpo en PPGR,
eje inoxidable y disco en PVC-U.

Código en FKM termina en "F"
en lugar de "E"

(A1) A utilizar con portabridas especial
QPV FK/FE no incluido.



FKOV/RM

| d | Ref. EPDM | DN | € EPDM | € FKM |
|----------|------------|-----|----------|-----------|
| 75 | FKOVRM075E | 65 | 1.003,45 | 1.201,48 |
| 90 | FKOVRM090E | 80 | 1.025,42 | 1.232,24 |
| 110 | FKOVRM110E | 100 | 1.062,11 | 1.283,63 |
| 125 (A1) | FKOVRM140E | 125 | 1.217,65 | 1.518,33 |
| 140 | FKOVRM140E | 125 | 1.217,65 | 1.518,33 |
| 160 | FKOVRM160E | 150 | 1.267,49 | 1.560,94 |
| 200 (A1) | FKOVRM225E | 200 | 1.600,53 | 1.983,45 |
| 225 | FKOVRM225E | 200 | 1.600,53 | 1.983,45 |
| 250**(B) | FKOVRM280E | 250 | 2.935,90 | 4.631,95 |
| 6" | FKOVRM280E | 250 | 2.935,90 | 4.631,95 |
| 8" | FKOVRM315E | 300 | 3.163,34 | 5.026,66 |
| 10" | FKOVRM355E | 350 | 5.735,78 | 9.616,90 |
| 12" | FKOVRM400E | 400 | 6.379,37 | 11.985,94 |

Válvula de mariposa industrial.

CON VOLANTE.

Cuerpo en PPGR,
eje inoxidable y disco
en PVC-U.

Código en FKM termina en "F"
en lugar de "E"

(A) A utilizar con portabridas especial
QPV FK/FE no incluido.

(B) A utilizar con tubo D250 SDR26 (PN10)
** ANSI 150 lbs bajo pedido al mismo precio



FKOV/FM

| d | Ref. EPDM | DN | € EPDM | € FKM |
|----------|-------------|-----|----------|----------|
| 75 | FKOLVFM075E | 65 | 534,01 | 732,02 |
| 90 | FKOLVFM090E | 80 | 620,55 | 827,43 |
| 110 | FKOLVFM110E | 100 | 673,35 | 896,40 |
| 125 (A1) | FKOLVFM140E | 125 | 896,40 | 1.198,55 |
| 140 | FKOLVFM140E | 125 | 896,40 | 1.198,55 |
| 160 | FKOLVFM160E | 150 | 982,94 | 1.295,43 |
| 200 (A1) | FKOLVFM225E | 200 | 1.175,09 | 1.582,89 |
| 225 | FKOLVFM225E | 200 | 1.175,09 | 1.582,89 |

Válvula de mariposa industrial.

A EJE LIBRE. LUG ISO-DIN.

Para actuar. Cuerpo en PPGR,
eje inoxidable y disco en PVC-U.

Código en FKM termina en "F"
en lugar de "E"

Para recambios de las válvulas consultar el último apartado "Recambios" de esta misma tarifa.



FKOV/LM

| d | Ref. EPDM | DN | € EPDM | € FKM |
|----------|-------------|-----|----------|----------|
| 75 | FKOLVLM075E | 65 | 595,58 | 793,66 |
| 90 | FKOLVLM090E | 80 | 671,89 | 878,74 |
| 110 | FKOLVLM110E | 100 | 730,55 | 952,11 |
| 125 (A1) | FKOLVLM140E | 125 | 972,61 | 1.273,33 |
| 140 | FKOLVLM140E | 125 | 972,61 | 1.273,33 |
| 160 | FKOLVLM160E | 150 | 1.050,42 | 1.343,79 |
| 200 (A1) | FKOLVLM225E | 200 | 1.263,05 | 1.645,99 |
| 225 | FKOLVLM225E | 200 | 1.263,05 | 1.645,99 |

Válvula de mariposa industrial.
CON MANETA. LUG ISO-DIN.
 Cuerpo en PPGR,
 eje inoxidable y disco en PVC-U.

Código en FKM termina en "F"
 en lugar de "E"
 (A1) A utilizar con portabridas
 especial QPV FK/FE no incluido.



FKOV/RM

| d | Ref. EPDM | DN | € EPDM | € FKM |
|----------|-------------|-----|----------|----------|
| 75 | FKOLVRM075E | 65 | 1.185,39 | 1.383,41 |
| 90 | FKOLVRM090E | 80 | 1.263,05 | 1.469,90 |
| 110 | FKOLVRM110E | 100 | 1.320,27 | 1.541,82 |
| 125 (A1) | FKOLVRM140E | 125 | 1.562,41 | 1.863,07 |
| 140 | FKOLVRM140E | 125 | 1.562,41 | 1.863,07 |
| 160 | FKOLVRM160E | 150 | 1.640,13 | 1.933,50 |
| 200 (A1) | FKOLVRM225E | 200 | 1.986,31 | 2.369,25 |
| 225 | FKOLVRM225E | 200 | 1.986,31 | 2.369,25 |

Válvula de mariposa industrial.
CON VOLANTE. LUG ISO-DIN.
 Cuerpo en PPGR,
 eje inoxidable y disco en PVC-U.

Código en FKM termina en "F"
 en lugar de "E"
 (A1) A utilizar con portabridas
 especial QPV FK/FE no incluido.



FKOV/FM

| d | Ref. EPDM | DN | € EPDM | € FKM |
|-----|--------------|-----|----------|----------|
| 2½" | FKOALVFM212E | 65 | 624,92 | 822,96 |
| 3" | FKOALVFM300E | 80 | 715,91 | 922,76 |
| 4" | FKOALVFM400E | 100 | 777,53 | 1.000,47 |
| 5" | FKOALVFM500E | 125 | 1.034,25 | 1.336,47 |
| 6" | FKOALVFM600E | 150 | 1.132,54 | 1.445,05 |
| 8" | FKOALVFM800E | 200 | 1.367,22 | 1.775,03 |
| 10" | FKOALVFM810E | 250 | 4.365,83 | 6.076,59 |
| 12" | FKOALVFM812E | 300 | 4.635,67 | 6.500,51 |

Válvula de mariposa industrial.
A EJE LIBRE. LUG ANSI.
 Para actuar. Cuerpo en PPGR,
 eje inoxidable y disco en PVC-U.

Código en FKM termina en "F"
 en lugar de "E"



FKOV/LM

| d | Ref. EPDM | DN | € EPDM | € FKM |
|-----|--------------|-----|----------|----------|
| 2½" | FKOALVLM212E | 65 | 686,56 | 884,61 |
| 3" | FKOALVLM300E | 80 | 767,25 | 974,05 |
| 4" | FKOALVLM400E | 100 | 834,75 | 1.056,22 |
| 5" | FKOALVLM500E | 125 | 1.110,51 | 1.411,29 |
| 6" | FKOALVLM600E | 150 | 1.199,97 | 1.493,43 |
| 8" | FKOALVLM800E | 200 | 1.455,20 | 1.838,14 |

Válvula de mariposa industrial.
CON MANETA. LUG ANSI.
 Cuerpo en PPGR,
 eje inoxidable y disco en PVC-U.

Código en FKM termina en "F"
 en lugar de "E"



FKOV/RM

| d | Ref. EPDM | DN | € EPDM | € FKM |
|-----|--------------|-----|----------|----------|
| 2½" | FKOALVRM212E | 65 | 1.276,31 | 1.474,35 |
| 3" | FKOALVRM300E | 80 | 1.358,41 | 1.565,28 |
| 4" | FKOALVRM400E | 100 | 1.424,42 | 1.645,99 |
| 5" | FKOALVRM500E | 125 | 1.700,26 | 2.001,03 |
| 6" | FKOALVRM600E | 150 | 1.789,78 | 2.083,16 |
| 8" | FKOALVRM800E | 200 | 2.178,43 | 2.561,35 |
| 10" | FKOALVRM810E | 250 | 4.785,52 | 6.481,58 |
| 12" | FKOALVRM812E | 300 | 5.055,25 | 6.918,61 |

Válvula de mariposa industrial.
CON VOLANTE. LUG ANSI.
 Cuerpo en PPGR,
 eje inoxidable y disco en PVC-U.

Código en FKM termina en "F"
 en lugar de "E"

Para recambios de las válvulas consultar el último apartado "Recambios" de esta misma tarifa.



Válvulas manuales de PVC-U presión

Válvulas y grifos de membrana



DKDV

| d | Ref. EPDM | DN | € EPDM | € FKM | € PTFE |
|----|-----------|----|--------|--------|--------|
| 20 | DKDV020E | 15 | 97,29 | 172,59 | 202,04 |
| 25 | DKDV025E | 20 | 108,33 | 181,79 | 211,11 |
| 32 | DKDV032E | 25 | 132,23 | 207,48 | 238,76 |
| 40 | DKDV040E | 32 | 156,09 | 284,55 | 317,64 |
| 50 | DKDV050E | 40 | 214,93 | 341,49 | 374,57 |
| 63 | DKDV063E | 50 | 262,48 | 475,55 | 469,90 |
| 75 | DKDV075E | 65 | 315,00 | 570,65 | 563,91 |

Válvula de membrana
DIALOCK®.
M-M encolar.

Código en FKM termina en "F"
en lugar de "E"
Código en PTFE termina en "P"
en lugar de "E"



DKLDV

| d | Ref. EPDM | DN | € EPDM | € FKM | € PTFE |
|----|-----------|----|--------|--------|--------|
| 20 | DKLDV020E | 15 | 244,07 | 319,34 | 348,81 |
| 25 | DKLDV025E | 20 | 255,13 | 328,57 | 357,87 |
| 32 | DKLDV032E | 25 | 279,01 | 354,23 | 385,53 |
| 40 | DKLDV040E | 32 | 302,84 | 431,28 | 464,39 |
| 50 | DKLDV050E | 40 | 403,60 | 530,17 | 546,87 |
| 63 | DKLDV063E | 50 | 451,21 | 664,23 | 639,44 |
| 75 | DKLDV075E | 65 | 541,41 | 797,09 | 767,33 |

Válvula de membrana
DIALOCK®. **CON LIMITADOR
DE CARRERA.**
M-M encolar.

Código en FKM termina en "F"
en lugar de "E"
Código en PTFE termina en "P"
en lugar de "E"



VMDV

| d | Ref. EPDM | DN | € EPDM | € FKM | € PTFE |
|-----|-----------|-----|----------|----------|----------|
| 90 | VMDV090E | 80 | 752,79 | 1.345,75 | 1.033,55 |
| 110 | VMDV110E | 100 | 1.044,58 | 2.050,80 | 1.391,65 |

Válvula de membrana.
M-M encolar.

Código en FKM termina en "F"
en lugar de "E"
Código en PTFE termina en "P"
en lugar de "E"



DKUIV

| d | Ref. EPDM | DN | € EPDM | € FKM | € PTFE |
|----|-----------|----|--------|--------|--------|
| 20 | DKUIV020E | 15 | 117,57 | 196,41 | 234,97 |
| 25 | DKUIV025E | 20 | 128,60 | 216,71 | 253,43 |
| 32 | DKUIV032E | 25 | 159,80 | 249,80 | 284,55 |
| 40 | DKUIV040E | 32 | 190,97 | 334,09 | 374,57 |
| 50 | DKUIV050E | 40 | 260,65 | 413,13 | 453,48 |
| 63 | DKUIV063E | 50 | 321,22 | 563,59 | 556,22 |

Válvula de membrana
DIALOCK®.
Con enlces H-H para encolar.

Código en FKM termina en "F"
en lugar de "E"
Código en PTFE termina en "P"
en lugar de "E"



DKLUIV

| d | Ref. EPDM | DN | € EPDM | € FKM | € PTFE |
|----|------------|----|--------|--------|--------|
| 20 | DKLUIV020E | 15 | 264,31 | 343,17 | 381,75 |
| 25 | DKLUIV025E | 20 | 275,37 | 363,44 | 400,18 |
| 32 | DKLUIV032E | 25 | 306,52 | 396,57 | 431,31 |
| 40 | DKLUIV040E | 32 | 337,75 | 480,87 | 521,32 |
| 50 | DKLUIV050E | 40 | 449,32 | 601,83 | 642,18 |
| 63 | DKLUIV063E | 50 | 509,92 | 752,26 | 744,92 |

Válvula de membrana
DIALOCK®. **CON LIMITADOR
DE CARRERA.**
Con enlces H-H para encolar.

Código en FKM termina en "F"
en lugar de "E"
Código en PTFE termina en "P"
en lugar de "E"



DKUFV

| Rh | Ref. EPDM | DN | PN | € EPDM | € FKM | € PTFE |
|-----|-----------|----|----|--------|--------|--------|
| ½" | DKUFV012E | 15 | 10 | 128,60 | 207,48 | 246,00 |
| ¾" | DKUFV034E | 20 | 10 | 139,47 | 229,53 | 264,41 |
| 1" | DKUFV100E | 25 | 10 | 170,73 | 258,85 | 295,57 |
| 1¼" | DKUFV114E | 32 | 10 | 225,76 | 368,97 | 407,53 |
| 1½" | DKUFV120E | 40 | 10 | 230,29 | 345,32 | 377,66 |
| 2" | DKUFV200E | 50 | 10 | 359,77 | 602,17 | 592,94 |

Válvula de membrana
DIALOCK®.
Con enlces H-H para rosacar.

Código en FKM termina en "F"
en lugar de "E"
Código en PTFE termina en "P"
en lugar de "E"

Para recambios de las válvulas consultar el último apartado "Recambios" de esta misma tarifa.



DKOV

| d | Ref. EPDM | DN | PN | € EPDM | € FKM | € PTFE |
|----|-----------------|----|----|---------------|---------------|---------------|
| 20 | DKOV020E | 15 | 10 | 161,01 | 236,27 | 265,70 |
| 25 | DKOV025E | 20 | 10 | 175,17 | 248,65 | 277,96 |
| 32 | DKOV032E | 25 | 10 | 201,88 | 277,12 | 308,33 |
| 40 | DKOV040E | 32 | 10 | 248,80 | 377,27 | 410,38 |
| 50 | DKOV050E | 40 | 10 | 312,15 | 438,73 | 471,81 |
| 63 | DKOV063E | 50 | 10 | 398,69 | 611,77 | 606,17 |
| 75 | DKOV075E | 65 | 10 | 518,31 | 795,33 | 788,04 |

Válvula de membrana
DIALOCK®.

Con bridas DIN.

Código en FKM termina en "F"
en lugar de "E"

Código en PTFE termina en "P"
en lugar de "E"

* DIN y ANSI 150lbs.



DKOAV

| d | Ref. EPDM | DN | PN | € EPDM | € FKM | € PTFE |
|-----|------------------|----|----|---------------|---------------|---------------|
| ½" | DKOAV012E | 15 | 10 | 161,01 | 236,27 | 265,70 |
| ¾" | DKOAV034E | 20 | 10 | 175,17 | 248,65 | 277,96 |
| 1" | DKOAV100E | 25 | 10 | 201,88 | 277,12 | 308,33 |
| 1¼" | DKOAV114E | 32 | 10 | 248,80 | 377,27 | 410,38 |
| 1½" | DKOAV120E | 40 | 10 | 238,70 | 335,49 | 360,80 |
| 2" | DKOAV200E | 50 | 10 | 398,69 | 611,77 | 606,17 |
| 2½" | DKOAV212E | 65 | 10 | 518,31 | 795,33 | 788,04 |

Válvula de membrana
DIALOCK®.

Con bridas ANSI 150 lbs.

Código en FKM termina en "F"
en lugar de "E"

Código en PTFE termina en "P"
en lugar de "E"



VMOV

| d | Ref. EPDM | DN | € EPDM | € FKM | € PTFE |
|-----|-----------------|-----|-----------------|-----------------|-----------------|
| 90 | VMOV090E | 80 | 1.023,16 | 1.616,15 | 1.304,01 |
| 110 | VMOV110E | 100 | 1.361,00 | 2.367,21 | 1.708,11 |

Válvula de membrana
Con bridas DIN.

Bajo pedido con bridas ANSI 150 lbs.
(con el mismo precio)

Código en FKM termina en "F"
en lugar de "E"

Código en PTFE termina en "P"
en lugar de "E"

CMDV

M-M encolar.

CMIV

H-H encolar.

CMUIV

H-H enlaces
encolar

CMFV

H-H roscar.



| d-Rh | Ref. EPDM | DN | € EPDM | € FKM | € FKM |
|------|------------------|----|---------------|---------------|---------------|
| 20 | CMDV020E | 15 | 95,54 | 135,81 | 143,25 |
| 16 | CMIV016E | 12 | 78,91 | 110,16 | 124,83 |
| 20 | CMIV020E | 15 | 100,95 | 124,83 | 134,04 |
| 20 | CMUIV020E | 15 | 110,16 | 141,41 | 146,88 |
| ¾" | CMFV038E | 12 | 78,91 | 110,16 | 124,83 |
| ½" | CMFV012E | 15 | 100,95 | 124,83 | 134,04 |

Válvula de membrana
compacta.

Código en FKM termina en "F"
en lugar de "E"

Código en PTFE termina en "P"
en lugar de "E"



RPDRV

| Rm-d | Ref. | DN | U/⊠ | € FKM |
|-------|---------------------|----|-----|--------------|
| ½"-16 | RPDRV012016F | 15 | 50 | 51,53 |

Grifo de pistón hidroponía.

Membrana en FKM. M espiga - M roscar.



RMRPV

| Rm-Pm | Ref. | DN | € EPDM |
|-------|---------------------|----|--------------|
| ½"-20 | RMRPV012020E | 15 | 36,47 |

Grifo de membrana.

Membrana en EPDM. M espiga - M roscar.



VMFV

| Rh | Ref. | DN | U/⊠ | € EPDM |
|----|-----------------|----|-----|--------------|
| ¼" | VMFV014E | 8 | 1 | 51,26 |

Grifo de membrana.

Membrana en EPDM. H-H roscar.



RMRV

| Rm | Ref. | DN | U/⊠ | € EPDM |
|----|-----------------|----|-----|--------------|
| ½" | RMRV012E | 15 | 1 | 36,47 |

Grifo de membrana.

Membrana en EPDM. M-M roscar.

Para recambios de las válvulas consultar el último apartado "Recambios" de esta misma tarifa.

**VMIV**

| d | Ref. | DN | U/ | € EPDM |
|----|-----------------|----|----|--------------|
| 12 | VMIV012E | 8 | 1 | 48,14 |

Grifo de membrana.

Membrana en EPDM. H-H

**VVUIV**

| d | Ref. | DN | PN | U/ | € EPDM |
|----|------------------|----|----|----|---------------|
| 16 | VVUIV016E | 10 | 16 | 6 | 67,87 |
| 20 | VVUIV020E | 15 | 16 | 6 | 69,33 |
| 25 | VVUIV025E | 20 | 16 | 6 | 79,38 |
| 32 | VVUIV032E | 25 | 16 | 6 | 94,49 |
| 40 | VVUIV040E | 32 | 10 | 16 | 124,44 |
| 50 | VVUIV050E | 40 | 10 | 16 | 166,18 |
| 63 | VVUIV063E | 50 | 10 | 16 | 248,85 |

Válvula asiento inclinado.

Junta EPDM. H-H enlaces para encolar.

**VVDV**

| d | Ref. | DN | PN | U/ | € EPDM |
|----|-----------------|----|----|----|---------------|
| 16 | VVDV016E | 10 | 16 | 6 | 59,29 |
| 20 | VVDV020E | 15 | 16 | 6 | 62,37 |
| 25 | VVDV025E | 20 | 16 | 6 | 68,99 |
| 32 | VVDV032E | 25 | 16 | 6 | 82,15 |
| 40 | VVDV040E | 32 | 10 | 16 | 108,25 |
| 50 | VVDV050E | 40 | 10 | 16 | 144,50 |
| 63 | VVDV063E | 50 | 10 | 16 | 209,99 |

Válvula asiento inclinado.

Junta EPDM. M-M encolar.

Para recambios de las válvulas consultar el último apartado "Recambios" de esta misma tarifa.



INDUSTRIA

Válvulas manuales de PVC-U presión

Válvulas de retención

**SXEIV**

| d | Ref. EPDM | DN | PN | Pack | U/ | € EPDM | € FKM |
|-----|------------------|-----|----|------|----|---------------|---------------|
| 16 | SXEIV016E | 10 | 16 | 2 | 30 | 31,10 | 32,91 |
| 20 | SXEIV020E | 15 | 16 | 2 | 30 | 31,25 | 33,03 |
| 25 | SXEIV025E | 20 | 16 | 2 | 30 | 36,09 | 36,85 |
| 32 | SXEIV032E | 25 | 16 | 2 | 20 | 38,31 | 40,01 |
| 40 | SXEIV040E | 32 | 16 | 2 | 14 | 47,71 | 53,83 |
| 50 | SXEIV050E | 40 | 16 | 2 | 6 | 58,69 | 62,82 |
| 63 | SXEIV063E | 50 | 16 | 2 | 6 | 85,26 | 100,14 |
| 75 | SXEIV075E | 65 | 16 | 2 | 2 | 196,57 | 210,33 |
| 90 | SXEIV090E | 80 | 16 | 2 | 2 | 246,57 | 262,35 |
| 110 | SXEIV110E | 100 | 16 | 2 | 2 | 323,57 | 356,95 |

Válvula de bola anti-retorno.

Juntas en EPDM o FKM. H-H encolar.

Código en FKM termina en "F" en lugar de "E"

**SXEIV**

| Rh | Ref. EPDM | DN | PN | Pack | U/ | € EPDM | € FKM |
|--------|------------------|-----|----|------|----|---------------|---------------|
| 3/8" | SXEIV038E | 10 | 16 | 2 | 30 | 33,51 | Consultar |
| 1/2" | SXEIV012E | 15 | 16 | 2 | 30 | 33,61 | Consultar |
| 3/4" | SXEIV034E | 20 | 16 | 2 | 30 | 39,70 | Consultar |
| 1" | SXEIV100E | 25 | 16 | 2 | 20 | 44,01 | Consultar |
| 1 1/4" | SXEIV114E | 32 | 16 | 2 | 14 | 52,91 | Consultar |
| 1 1/2" | SXEIV112E | 40 | 16 | 2 | 6 | 64,05 | Consultar |
| 2" | SXEIV200E | 50 | 16 | 2 | 6 | 100,90 | Consultar |
| 2 1/2" | SXEIV212E | 65 | 16 | 2 | 2 | 223,95 | 237,71 |
| 3" | SXEIV300E | 80 | 16 | 2 | 2 | 280,27 | 296,07 |
| 4" | SXEIV400E | 100 | 16 | 2 | 2 | 340,91 | 374,29 |

Válvula de bola anti-retorno.

Juntas en EPDM o FKM. H-H roscar.

* Consultar

Código en FKM termina en "F" en lugar de "E"

**SXEIV**

| d | Ref. EPDM | DN | PN | U/ | € EPDM | € FKM |
|-----|------------------|-----|----|----|---------------|---------------|
| 75 | SXEIV075E | 65 | 16 | 1 | 229,97 | 239,78 |
| 90 | SXEIV090E | 80 | 16 | 1 | 288,51 | 299,07 |
| 110 | SXEIV110E | 100 | 16 | 1 | 378,60 | 406,93 |

Válvula de bola anti-retorno.

Junta EPDM o FKM.

Long spigot PE100 SDR11.

Código en FKM termina en "F" en lugar de "E"

**VZIV**

| d-Rh | Ref. EPDM | DN | PN | U/ | € EPDM |
|-----------|-----------------|----|----|----|---------------|
| 16-3/8" | VZIV016E | 10 | 16 | 16 | 54,56 |
| 20-1/2" | VZIV020E | 15 | 16 | 16 | 55,92 |
| 25-3/4" | VZIV025E | 20 | 16 | 16 | 63,19 |
| 32-1" | VZIV032E | 25 | 16 | 6 | 68,19 |
| 40-1 1/4" | VZIV040E | 32 | 16 | 3 | 76,87 |
| 50-1 1/2" | VZIV050E | 40 | 16 | 3 | 106,65 |
| 63-2" | VZIV063E | 50 | 16 | 3 | 152,03 |

Válvula de fondo / pie.

Juntas en EPDM.

H-M encolar - H-H roscar.

Se suministra con las piezas necesarias para convertir la válvula roscada hembra por ambos extremos.

**SXE SSE**

| d | Ref. EPDM | DN | € |
|-------|-----------------|-------|--------------|
| 16-20 | HAVXE020 | 10-15 | 4,11 |
| 25 | HAVXE025 | 20 | 6,05 |
| 32 | HAVXE032 | 25 | 8,76 |
| 40 | HAVXE040 | 32 | 17,24 |
| 50 | HAVXE050 | 40 | 17,55 |
| 63 | HAVXE063 | 50 | 28,11 |

Maneta multifunción EASYFIT

Para apretar tuercas de válvulas

SXE - SSE.

Para recambios de las válvulas consultar el último apartado "Recambios" de esta misma tarifa.



SSEIV

| d | Ref. EPDM | DN | PN | Pack | U/ | € EPDM | € FKM |
|-----|------------------|-----|----|------|----|---------------|---------------|
| 16 | SSEIV016E | 10 | 16 | 2 | 30 | 27,22 | 28,83 |
| 20 | SSEIV020E | 15 | 16 | 2 | 30 | 27,36 | 28,93 |
| 25 | SSEIV025E | 20 | 16 | 2 | 30 | 31,65 | 32,30 |
| 32 | SSEIV032E | 25 | 16 | 2 | 20 | 33,58 | 35,07 |
| 40 | SSEIV040E | 32 | 16 | 2 | 14 | 41,82 | 47,21 |
| 50 | SSEIV050E | 40 | 16 | 2 | 6 | 51,47 | 55,08 |
| 63 | SSEIV063E | 50 | 16 | 2 | 6 | 74,73 | 87,77 |
| 75 | SSEIV075E | 65 | 16 | - | 1 | 172,28 | 184,30 |
| 90 | SSEIV090E | 80 | 16 | - | 1 | 216,14 | 229,92 |
| 110 | SSEIV110E | 100 | 16 | - | 1 | 283,61 | 312,80 |

Válvula de retención
con muelle en INOX 316.

Juntas en EPDM o FKM. H-H encolar.

Código en FKM termina en "F"
 en lugar de "E"



SSEFV

| Rh | Ref. EPDM | DN | PN | Pack | U/ | € EPDM | € FKM |
|--------|------------------|-----|----|------|----|---------------|---------------|
| 3/8" | SSEFV038E | 10 | 16 | 2 | 30 | 29,35 | 30,94 |
| 1/2" | SSEFV012E | 15 | 16 | 2 | 30 | 29,48 | 31,05 |
| 3/4" | SSEFV034E | 20 | 16 | 2 | 30 | 34,78 | 35,49 |
| 1" | SSEFV100E | 25 | 16 | 2 | 20 | 38,58 | 40,10 |
| 1 1/4" | SSEFV114E | 32 | 16 | 2 | 14 | 46,37 | 51,73 |
| 1 1/2" | SSEFV112E | 40 | 16 | 2 | 6 | 56,13 | 59,73 |
| 2" | SSEFV200E | 50 | 16 | 2 | 6 | 88,42 | 101,48 |
| 2 1/2" | SSEFV212E | 65 | 16 | - | 1 | 196,29 | 208,35 |
| 3" | SSEFV300E | 80 | 16 | - | 1 | 245,67 | 259,47 |
| 4" | SSEFV400E | 100 | 16 | - | 1 | 298,78 | 328,02 |

Válvula de retención
con muelle en INOX 316.

Juntas en EPDM o FKM. H-H roscar.

Código en FKM termina en "F"
 en lugar de "E"



SSEIV

| d | Ref. EPDM | DN | PN | Pack | U/ | € EPDM | € FKM |
|----|-------------------|----|----|------|----|--------------|--------------|
| 16 | SSEIV016EH | 10 | 16 | 2 | 30 | 81,39 | 82,99 |
| 20 | SSEIV020EH | 15 | 16 | 2 | 30 | 81,52 | 83,07 |
| 25 | SSEIV025EH | 20 | 16 | 2 | 30 | 88,61 | 89,29 |
| 32 | SSEIV032EH | 25 | 16 | 2 | 20 | 87,25 | 88,74 |

Válvula de retención
con muelle en HASTELLOY.

Juntas en EPDM o FKM. H-H encolar.

Código en FKM termina en "FH"
 en lugar de "EH"



SSEFV

| Rh | Ref. EPDM | DN | PN | Pack | U/ | € EPDM | € FKM |
|------|-------------------|----|----|------|----|--------------|--------------|
| 3/8" | SSEFV038EH | 10 | 16 | 2 | 30 | 83,74 | 85,36 |
| 1/2" | SSEFV012EH | 15 | 16 | 2 | 30 | 83,96 | 85,47 |
| 3/4" | SSEFV034EH | 20 | 16 | 2 | 30 | 92,22 | 92,92 |
| 1" | SSEFV100EH | 25 | 16 | 2 | 20 | 92,92 | 94,41 |

Válvula de retención
con muelle en HASTELLOY.

Juntas en EPDM o FKM. H-H roscar.

Código en FKM termina en "FH"
 en lugar de "EH"



SSEIV

| d | Ref. EPDM | DN | PN | Pack | U/ | € EPDM | € FKM |
|-----|--------------------|-----|----|------|----|---------------|---------------|
| 40 | SSEIV040E0P | 32 | 16 | 2 | 14 | 59,03 | 64,39 |
| 50 | SSEIV050E0P | 40 | 16 | 2 | 6 | 69,59 | 73,17 |
| 63 | SSEIV063E0P | 50 | 16 | 2 | 6 | 99,39 | 112,41 |
| 75 | SSEIV075E0P | 65 | 16 | - | 1 | 218,98 | 218,98 |
| 90 | SSEIV090E0P | 80 | 16 | - | 1 | 266,07 | 269,65 |
| 110 | SSEIV110E0P | 100 | 16 | - | 1 | 348,63 | 348,63 |

Válvula de retención
**con muelle en INOX
 recubierto de PTFE.**

Juntas en EPDM o FKM. H-H encolar.

Código en FKM termina en "F0P"
 en lugar de "E0P"



SSEFV

| Rh | Ref. EPDM | DN | PN | Pack | U/ | € EPDM | € FKM |
|--------|--------------------|-----|----|------|----|---------------|---------------|
| 1 1/4" | SSEFV114E0P | 32 | 16 | 2 | 14 | 64,21 | 69,63 |
| 1 1/2" | SSEFV112E0P | 40 | 16 | 2 | 6 | 74,91 | 78,51 |
| 2" | SSEFV200E0P | 50 | 16 | 2 | 6 | 115,03 | 128,07 |
| 2 1/2" | SSEFV212E0P | 65 | 16 | 1 | 1 | 246,39 | 246,39 |
| 3" | SSEFV300E0P | 80 | 16 | 1 | 1 | 303,33 | 303,33 |
| 4" | SSEFV400E0P | 100 | 16 | - | 1 | 365,97 | 365,97 |

Válvula de retención
**con muelle en INOX
 recubierto de PTFE.**

Juntas en EPDM o FKM. H-H roscar.

Código en FKM termina en "F0P"
 en lugar de "E0P"

Para recambios de las válvulas consultar el último apartado "Recambios" de esta misma tarifa.

**SSEBEV**

| d | Ref. EPDM | DN | PN | Pack | U/ | € EPDM | € FKM |
|-----|-------------------|-----|----|------|----|---------------|---------------|
| 75 | SSEBEV075E | 65 | 16 | - | 1 | 201,54 | 210,15 |
| 90 | SSEBEV090E | 80 | 16 | - | 1 | 252,86 | 262,09 |
| 110 | SSEBEV110E | 100 | 16 | - | 1 | 331,77 | 356,58 |

Válvula de retención
con muelle en INOX 316.

Juntas en EPDM o FKM.
Long spigot PE100 SDR11.

Código en FKM termina en "F"
en lugar de "E"

**SSEBEV**

| d | Ref. EPDM | DN | PN | Pack | U/ | € EPDM | € FKM |
|-----|---------------------|-----|----|------|----|---------------|---------------|
| 75 | SSEBEV075E0P | 65 | 16 | - | 1 | 249,95 | 249,67 |
| 90 | SSEBEV090E0P | 80 | 16 | - | 1 | 311,25 | 307,36 |
| 110 | SSEBEV110E0P | 100 | 16 | - | 1 | 392,62 | 397,43 |

Válvula de retención con muelle
en INOX recubierto PTFE.

Juntas en EPDM o FKM.
Long spigot PE100 SDR11.

Código en FKM termina en "F0P"
en lugar de "E0P"

**VRUIV**

| d | Ref. EPDM | DN | U/ | € EPDM | € FKM |
|----|------------------|----|----|---------------|---------------|
| 16 | VRUIV016E | 10 | 20 | 54,81 | 65,75 |
| 20 | VRUIV020E | 15 | 20 | 58,46 | 70,20 |
| 25 | VRUIV025E | 20 | 10 | 67,87 | 81,39 |
| 32 | VRUIV032E | 25 | 10 | 81,10 | 97,37 |
| 40 | VRUIV040E | 32 | 6 | 101,21 | 121,48 |
| 50 | VRUIV050E | 40 | 6 | 143,90 | 172,65 |
| 63 | VRUIV063E | 50 | 6 | 209,49 | 251,37 |

Válvula anti-retorno inclinada.

Juntas en EPDM o FKM.
H-H enlaces para encolar.

Código en FKM termina en "F"
en lugar de "E"

**VRUFV**

| Rh | Ref. EPDM | DN | PN | U/ | € EPDM |
|--------|------------------|----|----|----|---------------|
| 3/8" | VRUFV038E | 10 | 16 | 20 | 78,64 |
| 1/2" | VRUFV012E | 15 | 16 | 20 | 81,60 |
| 3/4" | VRUFV034E | 20 | 16 | 10 | 94,49 |
| 1" | VRUFV100E | 25 | 16 | 10 | 116,41 |
| 1 1/4" | VRUFV114E | 32 | 16 | 6 | 147,98 |
| 1 1/2" | VRUFV112E | 40 | 16 | 6 | 194,90 |
| 2" | VRUFV200E | 50 | 16 | 6 | 257,79 |

Válvula anti-retorno inclinada.

Juntas en EPDM. H-H enlaces para rosar.

**VRIV**

| d | Ref. EPDM | DN | PN | U/ | € EPDM |
|-----|-----------------|-----|----|----|---------------|
| 75 | VRIV075E | 65 | 10 | 2 | 312,67 |
| 90 | VRIV090E | 80 | 6 | 1 | 405,81 |
| 110 | VRIV110E | 100 | 6 | 1 | 713,68 |

Válvula anti-retorno inclinada.

Juntas en EPDM. H-H encolar.

**VRFV**

| Rh | Ref. EPDM | DN | PN | U/ | € EPDM |
|--------|-----------------|-----|----|----|---------------|
| 2 1/2" | VRFV212E | 65 | 10 | 2 | 435,72 |
| 3" | VRFV300E | 80 | 6 | 1 | 555,85 |
| 4" | VRFV400E | 100 | 6 | 1 | 732,68 |

Válvula anti-retorno inclinada.

Juntas en EPDM. H-H rosar.

**VRDV**

| d | Ref. EPDM | DN | PN | U/ | € EPDM |
|----|-----------------|----|----|----|---------------|
| 16 | VRDV016E | 10 | 16 | 20 | 47,67 |
| 20 | VRDV020E | 15 | 16 | 20 | 50,77 |
| 25 | VRDV025E | 20 | 16 | 20 | 58,95 |
| 32 | VRDV032E | 25 | 16 | 20 | 70,53 |
| 40 | VRDV040E | 32 | 16 | 12 | 87,95 |
| 50 | VRDV050E | 40 | 16 | 6 | 125,12 |
| 63 | VRDV063E | 50 | 16 | 6 | 181,56 |

Válvula anti-retorno inclinada.

Junta en EPDM. M-M encolar.

**SZIV/SZRV***

| d | Ref. encolar | Ref. rosar | € encolar | € rosar |
|----|----------------|----------------|--------------|--------------|
| 20 | SZIV016 | | 19,88 | - |
| 25 | SZIV020 | SZRV034 | 21,05 | 6,59 |
| 32 | SZIV025 | SZRV100 | 22,21 | 6,67 |
| 40 | SZIV032 | SZRV114 | 23,67 | 6,96 |
| 50 | SZIV040 | SZRV112 | 44,73 | 9,65 |
| 63 | SZIV050 | SZRV200 | 46,00 | 10,70 |
| 75 | SZIV063 | | 47,47 | - |

Tamiz filtro seguridad.

Para válvulas de fondo/pie. Encolar M / Roscar M.

Para recambios de las válvulas consultar el último apartado "Recambios" de esta misma tarifa.

**RVUIV**

| d | Ref. | DN | PN | U/ | € EPDM |
|----|-----------|----|----|----|--------|
| 16 | RVUIV016E | 10 | 16 | 20 | 45,53 |
| 20 | RVUIV020E | 15 | 16 | 20 | 45,53 |
| 25 | RVUIV025E | 20 | 16 | 10 | 52,67 |
| 32 | RVUIV032E | 25 | 16 | 10 | 71,77 |
| 40 | RVUIV040E | 32 | 16 | 6 | 90,83 |
| 50 | RVUIV050E | 40 | 16 | 6 | 118,89 |
| 63 | RVUIV063E | 50 | 16 | 6 | 154,81 |

Filtro inclinado PVC-U gris.

Juntas en EPDM. H-H enlaces para encolar.

**RVUIT**

| d | Ref. | DN | PN | U/ | € EPDM |
|----|-----------|----|----|----|--------|
| 16 | RVUIT016E | 10 | 16 | 20 | 45,53 |
| 20 | RVUIT020E | 15 | 16 | 20 | 45,53 |
| 25 | RVUIT025E | 20 | 16 | 10 | 52,67 |
| 32 | RVUIT032E | 25 | 16 | 10 | 71,77 |
| 40 | RVUIT040E | 32 | 10 | 6 | 90,83 |
| 50 | RVUIT050E | 40 | 10 | 6 | 118,89 |
| 63 | RVUIT063E | 50 | 10 | 6 | 154,81 |

Filtro inclinado PVC transparente.

Juntas en EPDM. H-H enlaces para encolar.

**RVIV**

| d | Ref. | DN | PN | U/ | € EPDM |
|-----|----------|-----|----|----|--------|
| 75 | RVIV075E | 65 | 10 | 2 | 201,31 |
| 90 | RVIV090E | 80 | 6 | 1 | 240,02 |
| 110 | RVIV110E | 100 | 6 | 1 | 565,29 |

Filtro inclinado PVC-U gris.

Juntas en EPDM. H-H encolar (sin enlaces en los extremos).

**RVIT**

| d | Ref. | DN | PN | U/ | € EPDM |
|-----|----------|-----|----|----|--------|
| 75 | RVIT075E | 65 | 6 | 2 | 213,50 |
| 90 | RVIT090E | 80 | 4 | 1 | 240,02 |
| 110 | RVIT110E | 100 | 4 | 1 | 565,29 |

Filtro inclinado PVC-U transparente.

Juntas en EPDM. H-H encolar (sin enlaces en los extremos).

**RVUFV**

| Rh | Ref. | DN | PN | U/ | € EPDM |
|--------|-----------|----|----|----|--------|
| 3/8" | RVUFV038E | 10 | 16 | 20 | 58,46 |
| 1/2" | RVUFV012E | 15 | 16 | 20 | 64,94 |
| 3/4" | RVUFV034E | 20 | 16 | 10 | 77,10 |
| 1" | RVUFV100E | 25 | 16 | 10 | 102,03 |
| 1 1/4" | RVUFV114E | 32 | 16 | 6 | 129,41 |
| 1 1/2" | RVUFV112E | 40 | 16 | 6 | 160,46 |
| 2" | RVUFV200E | 50 | 16 | 6 | 197,54 |

Filtro inclinado PVC-U gris.

Juntas en EPDM. H-H enlaces para roscar.

**RVFV**

| Rh | Ref. | DN | PN | U/ | € EPDM |
|--------|----------|-----|----|----|--------|
| 2 1/2" | RVFV212E | 65 | 10 | 2 | 322,14 |
| 3" | RVFV300E | 80 | 6 | 1 | 402,80 |
| 4" | RVFV400E | 100 | 6 | 1 | 603,11 |

Filtro inclinado PVC-U gris.

Juntas en EPDM. H-H roscar (sin enlaces en los extremos).

Para recambios de las válvulas consultar el último apartado "Recambios" de esta misma tarifa.



RVUFT

| Rh | Ref. | DN | PN | U/ | € EPDM |
|--------|------------------|----|----|----|---------------|
| 3/8" | RVUFT038E | 10 | 16 | 20 | 58,46 |
| 1/2" | RVUFT012E | 15 | 16 | 20 | 61,25 |
| 3/4" | RVUFT034E | 20 | 16 | 10 | 80,97 |
| 1" | RVUFT100E | 25 | 16 | 10 | 108,02 |
| 1 1/4" | RVUFT114E | 32 | 10 | 6 | 135,14 |
| 1 1/2" | RVUFT112E | 40 | 10 | 6 | 165,06 |
| 2" | RVUFT200E | 50 | 10 | 6 | 212,97 |

Filtro inclinado **PVC transparente**.
 Juntas en EPDM. H-H enlaces para roscar.



RVDV

| d | Ref. | DN | PN | U/ | € EPDM |
|----|-----------------|----|----|----|---------------|
| 16 | RVDV016E | 10 | 16 | 20 | 39,51 |
| 20 | RVDV020E | 15 | 16 | 20 | 39,51 |
| 25 | RVDV025E | 20 | 16 | 20 | 45,72 |
| 32 | RVDV032E | 25 | 16 | 20 | 62,37 |
| 40 | RVDV040E | 32 | 16 | 12 | 98,55 |
| 50 | RVDV050E | 40 | 16 | 6 | 103,44 |
| 63 | RVDV063E | 50 | 16 | 6 | 134,61 |

Filtro inclinado **PVC gris**.
 Junta en EPDM. M-M encolar.



RVDT

| d | Ref. | DN | PN | U/ | € EPDM |
|----|-----------------|----|----|----|---------------|
| 16 | RVDT016E | 10 | 10 | 20 | 41,07 |
| 20 | RVDT020E | 15 | 10 | 20 | 41,07 |
| 25 | RVDT025E | 20 | 10 | 20 | 47,60 |
| 32 | RVDT032E | 25 | 10 | 20 | 64,89 |
| 40 | RVDT040E | 32 | 10 | 12 | 82,17 |
| 50 | RVDT050E | 40 | 10 | 6 | 107,57 |
| 63 | RVDT063E | 50 | 10 | 6 | 140,01 |

Filtro inclinado **PVC transparente**.
 Junta en EPDM. M-M encolar.



RVFT

| Rh | Ref. | DN | PN | U/ | € EPDM |
|--------|-----------------|-----|----|----|---------------|
| 2 1/2" | RVFT212E | 65 | 6 | 2 | 331,60 |
| 3" | RVFT300E | 80 | 4 | 1 | 426,33 |
| 4" | RVFT400E | 100 | 4 | 1 | 612,57 |

Filtro inclinado **PVC-U transparente**.
 Juntas en EPDM. H-H roscar (sin enlaces en los extremos).



VAIV

| d-Rh | Ref. | DN | PN | U/ | € EPDM |
|-----------|-----------------|----|----|----|---------------|
| 20-1/2" | VAIV020E | 15 | 16 | 16 | 55,92 |
| 25-3/4" | VAIV025E | 20 | 16 | 20 | 63,24 |
| 32-1" | VAIV032E | 25 | 16 | 6 | 68,52 |
| 40-1 1/4" | VAIV040E | 32 | 16 | 3 | 74,43 |
| 50-1 1/2" | VAIV050E | 40 | 16 | 3 | 106,97 |
| 63-2" | VAIV063E | 50 | 16 | 3 | 156,45 |

Válvula de purga bola ventosa. Se suministra con las piezas necesarias para convertir la válvula roscada hembra por ambos extremos.
 Junta en EPDM.
 H-M encolar / H-H roscar.

Para recambios de las válvulas consultar el último apartado "Recambios" de esta misma tarifa.



0904

Válvulas de solenoide

INDUSTRIA





INDUSTRIA

Válvulas de solenoide



| | | | | | |
|-------------------|-----------------------|--------------------|---|---|---|
| 1 | 2 | 3 | 4 | 5 | 7 |
| Serie: | Modelo pequeño S1 | | | | |
| | Modelo grande S2 | | | | |
| Vías: | Dos vías 2 | | | | |
| Conexión: | Encolar I | | | | |
| | Roscar F | | | | |
| DN: | Modelo pequeño | 4-6-8 | | | |
| | Modelo grande | 8-10-15 | | | |
| Diámetro: | Modelo pequeño | 10-12-16-1/4"-3/8" | | | |
| | Modelo grande | 16-20-3/8"-1/2" | | | |
| Juntas: | EPDM-FKM | | | | |
| Voltaje: | 12V-24V-48V-110V-230V | | | | |
| Corriente: | AC-DC | | | | |

Válvula de bola maneta azul.

H-H encolar. Junta EPDM - Asiento PE. Bidireccional.



S12IV

| d | Ref. | DN | Voltaje | Corriente | € EPDM |
|----|-------------|----|---------|-----------|--------|
| 16 | S12I0416E2A | 04 | 24 V* | Alterna | 275,04 |
| 16 | S12I0616E2A | 06 | 24 V* | Alterna | 275,04 |
| 16 | S12I0816E2A | 08 | 24 V* | Alterna | 275,04 |
| 16 | S12I0416E2C | 04 | 24 V* | Continua | 275,04 |
| 16 | S12I0616E2C | 06 | 24 V* | Continua | 275,04 |
| 16 | S12I0816E2C | 08 | 24 V* | Continua | 275,04 |
| 16 | S12I0416E5A | 04 | 230 V* | Alterna | 275,04 |
| 16 | S12I0616E5A | 06 | 230 V* | Alterna | 275,04 |
| 16 | S12I0816E5A | 08 | 230 V* | Alterna | 275,04 |

Válvula de solenoide 2 vías **ENCOLAR**. Modelo pequeño.

Juntas EPDM. H-H encolar.

* Voltaje estándar. Disponibles otras conexiones para encolar: BS y ASTM

Disponibles también en diámetro exterior Ø 10 y 12 mm. al mismo precio que las de Ø 16 mm.



S12-S22

| d | Modelo encolar | Rh | Ref. | DN | € EPDM | € FKM |
|----|----------------|------|-------|----------|--------|--------|
| 10 | S12IV | | S12FV | 4-6-8-10 | 267,01 | 266,06 |
| 12 | S12IV | 1/4" | S12FV | 4-6-8-10 | 267,01 | 266,06 |
| 16 | S12IV | 3/8" | S22FV | 4-6-8-10 | 267,01 | 266,06 |
| 16 | S22IV | 3/8" | S22FV | 8-10-15 | 339,94 | 345,86 |
| 20 | S22IV | 1/2" | S22IV | 8-10-15 | 339,94 | 345,86 |

Resumen

válvulas de solenoide 2 vías.

Voltaje estándar

24 ó 230 V AC 50/60 Hz, 24 V DC

Bajo pedido:

48, 110 V AC 50/60 Hz y 12, 48

V DC



S12IV

| d | Ref. | DN | Voltaje | Corriente | € F |
|----|-------------|----|---------|-----------|--------|
| 16 | S12I0416F2A | 04 | 24 V* | Alterna | 290,49 |
| 16 | S12I0616F2A | 06 | 24 V* | Alterna | 290,49 |
| 16 | S12I0816F2A | 08 | 24 V* | Alterna | 290,49 |
| 16 | S12I1016F2A | 10 | 24 V* | Alterna | 290,49 |
| 16 | S12I0416F2C | 04 | 24 V* | Continua | 290,49 |
| 16 | S12I0616F2C | 06 | 24 V* | Continua | 290,49 |
| 16 | S12I0816F2C | 08 | 24 V* | Continua | 290,49 |
| 16 | S12I0416F5A | 04 | 230 V* | Alterna | 290,49 |
| 16 | S12I0616F5A | 06 | 230 V* | Alterna | 290,49 |
| 16 | S12I0816F5A | 08 | 230 V* | Alterna | 290,49 |
| 16 | S12I1016F5A | 10 | 230 V* | Alterna | 290,49 |

Válvula de solenoide 2 vías **ENCOLAR**. Modelo pequeño.

Juntas FKM. H-H encolar.

* Voltaje estándar. Disponibles otras conexiones para encolar: BS y ASTM

Disponibles también en diámetro exterior Ø 10 y 12 mm. al mismo precio que las de Ø 16 mm.

Marcadas en amarillo los modelos estándar

Para recambios de las válvulas consultar el último apartado "Recambios" de esta misma tarifa.



S12FV

| Rh | Ref. | DN | Voltaje | Corriente | € EPDM |
|------|-------------|----|---------|-----------|-----------|
| 3/8" | S12F0438E2A | 04 | 24 V* | Alterna | 275,04 |
| 3/8" | S12F0638E2A | 06 | 24 V* | Alterna | 275,04 |
| 3/8" | S12F0838E2A | 08 | 24 V* | Alterna | 275,04 |
| 3/8" | S12F0438E2C | 04 | 24 V* | Continua | 275,04 |
| 3/8" | S12F0638E2C | 06 | 24 V* | Continua | 275,04 |
| 3/8" | S12F0838E2C | 08 | 24 V* | Continua | 275,04 |
| 3/8" | S12F0438E5A | 04 | 230 V* | Alterna | 275,04 |
| 3/8" | S12F0638E5A | 06 | 230 V* | Alterna | 275,04 |
| 3/8" | S12F0838E5A | 08 | 230 V* | Alterna | 275,04 |

Válvula de solenoide 2 vías ROSCAR. Modelo pequeño.

Juntas EPDM. H-H roscar.

* Voltaje estándar. Disponibles otras conexiones para encolar: NPT

Disponibles también en diámetro exterior Ø 1/4" al mismo precio que las de diámetro exterior Ø 3/8".



S12FV

| Rh | Ref. | DN | Voltaje | Corriente | € F |
|------|-------------|----|---------|-----------|--------|
| 3/8" | S12F0438F2A | 04 | 24 V* | Alterna | 290,49 |
| 3/8" | S12F0638F2A | 06 | 24 V* | Alterna | 290,49 |
| 3/8" | S12F0838F2A | 08 | 24 V* | Alterna | 290,49 |
| 3/8" | S12F1038F2A | 10 | 24 V* | Alterna | 290,49 |
| 3/8" | S12F0438F2C | 04 | 24 V* | Continua | 290,49 |
| 3/8" | S12F0638F2C | 06 | 24 V* | Continua | 290,49 |
| 3/8" | S12F0838F2C | 08 | 24 V* | Continua | 290,49 |
| 3/8" | S12F0438F5A | 04 | 230 V* | Alterna | 290,49 |
| 3/8" | S12F0638F5A | 06 | 230 V* | Alterna | 290,49 |
| 3/8" | S12F0838F5A | 08 | 230 V* | Alterna | 290,49 |
| 3/8" | S12F1038F5A | 10 | 230 V* | Alterna | 290,49 |

Válvula de solenoide 2 vías ROSCAR. Modelo pequeño.

Juntas FKM. H-H roscar.

* Voltaje estándar. Disponibles otras conexiones para encolar: NPT

Disponibles también en diámetro exterior Ø 1/4" al mismo precio que las de diámetro exterior Ø 3/8".

Marcadas en amarillo los modelos estándar



S22IV

| d | Ref. | DN | Voltaje | Corriente | € EPDM |
|----|-------------|----|---------|-----------|-----------|
| 20 | S22I0820E2A | 08 | 24 V* | Alterna | 350,15 |
| 20 | S22I1020E2A | 10 | 24 V* | Alterna | 350,15 |
| 20 | S22I1520E2A | 15 | 24 V* | Alterna | 350,15 |
| 20 | S22I0820E2C | 08 | 24 V* | Continua | 350,15 |
| 20 | S22I1020E2C | 10 | 24 V* | Continua | 350,15 |
| 20 | S22I1520E2C | 15 | 24 V* | Continua | 350,15 |
| 20 | S22I0820E5A | 08 | 230 V* | Alterna | 350,15 |
| 20 | S22I1020E5A | 10 | 230 V* | Alterna | 350,15 |
| 20 | S22I1520E5A | 15 | 230 V* | Alterna | 350,15 |

Válvula de solenoide 2 vías ENCOLAR. Modelo grande.

Juntas EPDM. H-H encolar.

* Voltaje estándar. Disponibles otras conexiones para encolar: BS y ASTM

Disponibles también en diámetro exterior Ø 16 mm. al mismo precio que las de Ø 20 mm.



S22IV

| d | Ref. | DN | Voltaje | Corriente | € FKM |
|----|-------------|----|---------|-----------|----------|
| 20 | S22I0820F2A | 08 | 24 V* | Alterna | 369,15 |
| 20 | S22I1020F2A | 10 | 24 V* | Alterna | 369,15 |
| 20 | S22I1520F2A | 15 | 24 V* | Alterna | 369,15 |
| 20 | S22I0820F2C | 08 | 24 V* | Continua | 369,15 |
| 20 | S22I1020F2C | 10 | 24 V* | Continua | 369,15 |
| 20 | S22I1520F2C | 15 | 24 V* | Continua | 369,15 |
| 20 | S22I0820F5A | 08 | 230 V* | Alterna | 369,15 |
| 20 | S22I1020F5A | 10 | 230 V* | Alterna | 369,15 |
| 20 | S22I1520F5A | 15 | 230 V* | Alterna | 369,15 |

Válvula de solenoide 2 vías ENCOLAR. Modelo grande.

Juntas FKM. H-H encolar.

* Voltaje estándar. Disponibles otras conexiones para encolar: BS y ASTM

Disponibles también en diámetro exterior Ø 16 mm. al mismo precio que las de Ø 20 mm.

Marcadas en amarillo los modelos estándar

Para recambios de las válvulas consultar el último apartado "Recambios" de esta misma tarifa.



S22FV

| Rh | Ref. | DN | Voltaje | Corriente | € EPDM |
|----|-------------|----|---------|-----------|-----------|
| ½" | S22F0812E2A | 08 | 24 V* | Alterna | 350,15 |
| ½" | S22F1012E2A | 10 | 24 V* | Alterna | 350,15 |
| ½" | S22F1512E2A | 15 | 24 V* | Alterna | 350,15 |
| ½" | S22F0812E2C | 08 | 24 V* | Continua | 350,15 |
| ½" | S22F1012E2C | 10 | 24 V* | Continua | 350,15 |
| ½" | S22F1512E2C | 15 | 24 V* | Continua | 350,15 |
| ½" | S22F0812E5A | 08 | 230 V* | Alterna | 350,15 |
| ½" | S22F1012E5A | 10 | 230 V* | Alterna | 350,15 |
| ½" | S22F1512E5A | 15 | 230 V* | Alterna | 350,15 |

Válvula de solenoide 2 vías **ROSCAR**. Modelo grande.

Juntas EPDM. *HH rosca*.

* Voltaje estándar. Disponibles otras conexiones para encolar: NPT.

Disponibles también en diámetro exterior Ø 3/8" al mismo precio que las de diámetro exterior Ø 1/2".



S22FV

| Rh | Ref. | DN | Voltaje | Corriente | € FKM |
|----|-------------|----|---------|-----------|----------|
| ½" | S22F0812F2A | 08 | 24 V* | Alterna | 369,15 |
| ½" | S22F1012F2A | 10 | 24 V* | Alterna | 369,15 |
| ½" | S22F1512F2A | 15 | 24 V* | Alterna | 369,15 |
| ½" | S22F0812F2C | 08 | 24 V* | Continua | 369,15 |
| ½" | S22F1012F2C | 10 | 24 V* | Continua | 369,15 |
| ½" | S22F1512F2C | 15 | 24 V* | Continua | 369,15 |
| ½" | S22F0812F5A | 08 | 230 V* | Alterna | 369,15 |
| ½" | S22F1012F5A | 10 | 230 V* | Alterna | 369,15 |
| ½" | S22F1512F5A | 15 | 230 V* | Alterna | 369,15 |

Válvula de solenoide 2 vías **ROSCAR**. Modelo grande.

Juntas FKM. *HH rosca*.

* Voltaje estándar. Disponibles otras conexiones para encolar: NPT.

Disponibles también en diámetro exterior Ø 3/8" al mismo precio que las de diámetro exterior Ø 1/2".

Marcadas en amarillo los modelos estándar

Válvulas de bola actuadas

Válvula de 3 vías actuadas

Válvulas de mariposa

Válvulas de membrana

Válvulas de control de presión



0808

Válvulas motorizadas PVC-U presión

INDUSTRIA





Válvulas motorizadas

Motorizando nuestra válvula industrial conseguimos que nuestras válvulas (con el par más bajo del mercado siendo estanca) puedan trabajar con un número de aperturas y cierres muy por encima de la media.

NO TODAS LAS VÁLVULAS MOTORIZADAS DEL MERCADO SON IGUALES O SEMEJANTES.

En estos artículos, donde el precio del actuador es más elevado que el de la válvula, es donde más énfasis hay que tener en colocar la mejor válvula del mercado. El precio de la válvula no se apreciará porque quedará absorbido por el precio del actuador. Una buena válvula hará que alargue su uso, su mantenimiento, su seguridad y su durabilidad.





INDUSTRIA

Válvulas motorizadas de PVC-U presión

Válvulas de bola actuadas



VKDIV/CE

encolar.

VKDFFV/CE

roscar.



ACTUACIÓN ELÉCTRICA

ACTUACIÓN ELÉCTRICA CON BLOQUE DE SEGURIDAD

| d-Rh | 24-240 V AC/DC | | 24-240 V AC/DC | | 24-240 V AC/DC | | 24-240 V AC/DC | |
|------|----------------|----------|----------------|----------|----------------|----------|----------------|----------|
| | Ref. | € EPDM | Ref. | € FKM | Ref. | € EPDM | Ref. | € FKM |
| 16 | VKVE016E2D | 625,73 | VKVE016F2D | 634,53 | VKVE016E2BD | 1.180,41 | VKVE016F2BD | 1.189,22 |
| 20 | VKVE020E2D | 627,37 | VKVE020F2D | 635,85 | VKVE020E2BD | 1.182,03 | VKVE020F2BD | 1.190,53 |
| 25 | VKVE025E2D | 638,14 | VKVE025F2D | 649,03 | VKVE025E2BD | 1.192,84 | VKVE025F2BD | 1.203,71 |
| 32 | VKVE032E2D | 650,75 | VKVE032F2D | 664,04 | VKVE032E2BD | 1.205,41 | VKVE032F2BD | 1.218,73 |
| 40 | VKVE040E2D | 673,55 | VKVE040F2D | 688,04 | VKVE040E2BD | 1.228,22 | VKVE040F2BD | 1.242,73 |
| 50 | VKVE050E2D | 696,47 | VKVE050F2D | 714,54 | VKVE050E2BD | 1.251,12 | VKVE050F2BD | 1.269,25 |
| 63 | VKVE063E2D | 725,05 | VKVE063F2D | 760,79 | VKVE063E2BD | 1.279,72 | VKVE063F2BD | 1.315,46 |
| 75 | VKVE075E2D | 1.160,84 | VKVE075F2D | 1.232,63 | VKVE075E2BD | 1.715,52 | VKVE075F2BD | 1.787,31 |
| 90 | VKVE090E2D | 1.260,65 | VKVE090F2D | 1.348,20 | VKVE090E2BD | 1.815,32 | VKVE090F2BD | 1.902,85 |
| 110 | VKVE110E2D | 1.696,10 | VKVE110F2D | 1.816,92 | VKVE110E2BD | 2.250,79 | VKVE110F2BD | 2.371,61 |

| | | | | | | | | |
|--------|------------|----------|------------|----------|-------------|----------|-------------|----------|
| 3/8" | VKVE038E2D | 628,92 | VKVE038F2D | 638,32 | VKVE038E2BD | 1.183,60 | VKVE038F2BD | 1.192,98 |
| 1/2" | VKVE012E2D | 631,08 | VKVE012F2D | 640,35 | VKVE012E2BD | 1.185,77 | VKVE012F2BD | 1.195,01 |
| 3/4" | VKVE034E2D | 643,18 | VKVE034F2D | 652,12 | VKVE034E2BD | 1.197,87 | VKVE034F2BD | 1.206,80 |
| 1" | VKVE100E2D | 655,96 | VKVE100F2D | 673,83 | VKVE100E2BD | 1.210,64 | VKVE100F2BD | 1.228,51 |
| 1 1/4" | VKVE114E2D | 681,81 | VKVE114F2D | 696,59 | VKVE114E2BD | 1.236,49 | VKVE114F2BD | 1.251,24 |
| 1 1/2" | VKVE112E2D | 709,03 | VKVE112F2D | 727,67 | VKVE112E2BD | 1.263,69 | VKVE112F2BD | 1.282,35 |
| 2" | VKVE200E2D | 742,35 | VKVE200F2D | 779,43 | VKVE200E2BD | 1.297,01 | VKVE200F2BD | 1.334,11 |
| 2 1/2" | VKVE212E2D | 1.190,01 | VKVE212F2D | 1.261,80 | VKVE212E2BD | 1.744,70 | VKVE212F2BD | 1.816,46 |
| 3" | VKVE300E2D | 1.297,78 | VKVE300F2D | 1.385,38 | VKVE300E2BD | 1.852,46 | VKVE300F2BD | 1.940,04 |
| 4" | VKVE400E2D | 1.737,85 | VKVE400F2D | 1.858,69 | VKVE400E2BD | 2.292,52 | VKVE400F2BD | 2.413,34 |

Válvula de bola motorizada en PVC-U 2 vías DUAL BLOCK®. Actuación eléctrica.

Disponemos de otras conexiones bajo pedido: bridas, encolar (BS, ASTM, JIS) y roscar (NPT, JIS). Bajo pedido podemos suministrar otros actuadores: VALPES, BELIMO...
Bajo pedido también disponibles en 12V AC/DC

VKRIV/CE

encolar.

VKRFV/CE

roscar.



ACTUACIÓN ELÉCTRICA 24-240 V AC/DC CON POSICIONADOR 4-20 mA

| d | Ref. | € | | Ref. | € | | Ref. | € | | Ref. | € | FKM | Rh |
|----|-------------|----------|----------|-------------|----------|----------|-------------|----------|----------|-------------|----------|--------|----|
| | | EPDM | FKM | | EPDM | FKM | | EPDM | FKM | | | | |
| 16 | VRVE016E2PD | 1.217,51 | 1.226,32 | VRVE016F2PD | 1.220,79 | 1.220,79 | VRVE038E2PD | 1.220,79 | 1.220,79 | VRVE038F2PD | 1.220,79 | 3/8" | |
| 20 | VRVE020E2PD | 1.219,24 | 1.227,64 | VRVE020F2PD | 1.222,90 | 1.222,90 | VRVE012E2PD | 1.222,90 | 1.222,90 | VRVE012F2PD | 1.222,90 | 1/2" | |
| 25 | VRVE025E2PD | 1.243,19 | 1.254,03 | VRVE025F2PD | 1.248,15 | 1.248,15 | VRVE034E2PD | 1.248,15 | 1.248,15 | VRVE034F2PD | 1.248,15 | 3/4" | |
| 32 | VRVE032E2PD | 1.281,66 | 1.294,95 | VRVE032F2PD | 1.286,91 | 1.286,91 | VRVE100E2PD | 1.286,91 | 1.286,91 | VRVE100F2PD | 1.286,91 | 1" | |
| 40 | VRVE040E2PD | 1.301,90 | 1.316,42 | VRVE040F2PD | 1.310,14 | 1.310,14 | VRVE114E2PD | 1.310,14 | 1.310,14 | VRVE114F2PD | 1.310,14 | 1 1/4" | |
| 50 | VRVE050E2PD | 1.377,06 | 1.395,17 | VRVE050F2PD | 1.389,68 | 1.389,68 | VRVE112E2PD | 1.389,68 | 1.389,68 | VRVE112F2PD | 1.389,68 | 1 1/2" | |
| 63 | VRVE063E2PD | 1.393,85 | 1.429,64 | VRVE063F2PD | 1.411,20 | 1.411,20 | VRVE200E2PD | 1.411,20 | 1.411,20 | VRVE200F2PD | 1.411,20 | 2" | |

Válvula de bola REGULACIÓN motorizada en PVC-U 2 vías DUAL BLOCK®. Actuación eléctrica con posicionador 4-20 mA

Disponemos de otras conexiones bajo pedido: bridas, encolar (BS, ASTM, JIS) y roscar (NPT, JIS). Bajo pedido también disponibles en 12V AC/DC

**VKDIV/CP**

encolar.

VKDFV/CP

roscar.

ACTUACIÓN NEUMÁTICA ALUMINIO

ACTUACIÓN NEUMÁTICA ALUMINIO CON ELECTROVÁLVULA, FINALES DE CARRERA (ELECTROMECAÑICOS) Y REGULADORES DE ESCAPE

| d-Rh | DOBLE EFECTO € | | SIMPLE EFECTO € | | DOBLE EFECTO € | | SIMPLE EFECTO € | |
|------|----------------|--------|-----------------|----------|----------------|----------|-----------------|----------|
| | Ref. | | Ref. | | Ref. | | Ref. | |
| 16 | VKVP016EDED | 288,35 | VKVP016ESED | 319,04 | VKVP016EDEFD | 488,97 | VKVP016ESEFD | 530,24 |
| 20 | VKVP020EDED | 289,98 | VKVP020ESED | 320,69 | VKVP020EDEFD | 490,62 | VKVP020ESEFD | 531,92 |
| 25 | VKVP025EDED | 300,76 | VKVP025ESED | 331,48 | VKVP025EDEFD | 501,40 | VKVP025ESEFD | 542,71 |
| 32 | VKVP032EDED | 313,38 | VKVP032ESED | 344,07 | VKVP032EDEFD | 514,00 | VKVP032ESEFD | 555,32 |
| 40 | VKVP040EDED | 336,17 | VKVP040ESED | 366,89 | VKVP040EDEFD | 536,82 | VKVP040ESEFD | 578,12 |
| 50 | VKVP050EDED | 359,11 | VKVP050ESED | 449,44 | VKVP050EDEFD | 559,73 | VKVP050ESEFD | 660,64 |
| 63 | VKVP063EDED | 387,67 | VKVP063ESED | 556,92 | VKVP063EDEFD | 588,28 | VKVP063ESEFD | 768,15 |
| 75 | VKVP075EDED | 662,17 | VKVP075ESED | 781,87 | VKVP075EDEFD | 862,76 | VKVP075ESEFD | 993,11 |
| 90 | VKVP090EDED | 761,97 | VKVP090ESED | 881,66 | VKVP090EDEFD | 962,57 | VKVP090ESEFD | 1.092,91 |
| 110 | VKVP110EDED | 846,74 | VKVP110ESED | 1.270,48 | VKVP110EDEFD | 1.047,39 | VKVP110ESEFD | 1.481,71 |

| | | | | | | | | |
|--------|-------------|--------|-------------|----------|--------------|----------|--------------|----------|
| 3/8" | VKVP038EDED | 291,54 | VKVP038ESED | 322,27 | VKVP038EDEFD | 492,19 | VKVP038ESEFD | 533,49 |
| 1/2" | VKVP012EDED | 293,74 | VKVP012ESED | 324,43 | VKVP012EDEFD | 494,35 | VKVP012ESEFD | 535,65 |
| 3/4" | VKVP034EDED | 305,81 | VKVP034ESED | 336,53 | VKVP034EDEFD | 506,43 | VKVP034ESEFD | 547,73 |
| 1" | VKVP100EDED | 318,58 | VKVP100ESED | 349,30 | VKVP100EDEFD | 519,22 | VKVP100ESEFD | 560,51 |
| 1 1/4" | VKVP114EDED | 344,41 | VKVP114ESED | 375,16 | VKVP114EDEFD | 545,06 | VKVP114ESEFD | 586,38 |
| 1 1/2" | VKVP112EDED | 371,65 | VKVP112ESED | 461,99 | VKVP112EDEFD | 572,27 | VKVP112ESEFD | 673,21 |
| 2" | VKVP200EDED | 405,00 | VKVP200ESED | 574,20 | VKVP200EDEFD | 605,59 | VKVP200ESEFD | 785,43 |
| 2 1/2" | VKVP212EDED | 691,34 | VKVP212ESED | 811,05 | VKVP212EDEFD | 891,96 | VKVP212ESEFD | 1.022,28 |
| 3" | VKVP300EDED | 799,07 | VKVP300ESED | 918,81 | VKVP300EDEFD | 999,70 | VKVP300ESEFD | 1.130,01 |
| 4" | VKVP400EDED | 888,51 | VKVP400ESED | 1.312,27 | VKVP400EDEFD | 1.089,15 | VKVP400ESEFD | 1.523,47 |

| | | | | | | | | |
|-----|-------------|--------|-------------|----------|--------------|----------|--------------|----------|
| 16 | VKVP016FDED | 297,16 | VKVP016FSED | 327,88 | VKVP016FDEFD | 497,78 | VKVP016FSEFD | 539,10 |
| 20 | VKVP020FDED | 298,47 | VKVP020FSED | 329,19 | VKVP020FDEFD | 499,09 | VKVP020FSEFD | 540,42 |
| 25 | VKVP025FDED | 311,66 | VKVP025FSED | 342,37 | VKVP025FDEFD | 512,30 | VKVP025FSEFD | 553,60 |
| 32 | VKVP032FDED | 326,66 | VKVP032FSED | 357,36 | VKVP032FDEFD | 527,31 | VKVP032FSEFD | 568,59 |
| 40 | VKVP040FDED | 350,66 | VKVP040FSED | 381,39 | VKVP040FDEFD | 551,31 | VKVP040FSEFD | 592,61 |
| 50 | VKVP050FDED | 377,19 | VKVP050FSED | 467,52 | VKVP050FDEFD | 577,83 | VKVP050FSEFD | 678,77 |
| 63 | VKVP063FDED | 423,41 | VKVP063FSED | 592,66 | VKVP063FDEFD | 624,06 | VKVP063FSEFD | 803,89 |
| 75 | VKVP075FDED | 733,93 | VKVP075FSED | 853,66 | VKVP075FDEFD | 934,57 | VKVP075FSEFD | 1.064,90 |
| 90 | VKVP090FDED | 849,47 | VKVP090FSED | 969,23 | VKVP090FDEFD | 1.050,12 | VKVP090FSEFD | 1.180,46 |
| 110 | VKVP110FDED | 967,56 | VKVP110FSED | 1.391,32 | VKVP110FDEFD | 1.168,21 | VKVP110FSEFD | 1.602,56 |

| | | | | | | | | |
|--------|-------------|----------|-------------|----------|--------------|----------|--------------|----------|
| 3/8" | VKVP038FDED | 300,95 | VKVP038FSED | 331,66 | VKVP038FDEFD | 501,56 | VKVP038FSEFD | 542,89 |
| 1/2" | VKVP012FDED | 302,97 | VKVP012FSED | 333,65 | VKVP012FDEFD | 503,60 | VKVP012FSEFD | 544,90 |
| 3/4" | VKVP034FDED | 314,75 | VKVP034FSED | 345,46 | VKVP034FDEFD | 515,39 | VKVP034FSEFD | 556,69 |
| 1" | VKVP100FDED | 336,48 | VKVP100FSED | 367,17 | VKVP100FDEFD | 537,07 | VKVP100FSEFD | 578,40 |
| 1 1/4" | VKVP114FDED | 359,21 | VKVP114FSED | 389,91 | VKVP114FDEFD | 559,84 | VKVP114FSEFD | 601,14 |
| 1 1/2" | VKVP112FDED | 390,30 | VKVP112FSED | 480,65 | VKVP112FDEFD | 590,94 | VKVP112FSEFD | 691,90 |
| 2" | VKVP200FDED | 442,06 | VKVP200FSED | 611,28 | VKVP200FDEFD | 642,67 | VKVP200FSEFD | 822,51 |
| 2 1/2" | VKVP212FDED | 763,08 | VKVP212FSED | 882,84 | VKVP212FDEFD | 963,72 | VKVP212FSEFD | 1.094,07 |
| 3" | VKVP300FDED | 886,68 | VKVP300FSED | 1.006,41 | VKVP300FDEFD | 1.087,30 | VKVP300FSEFD | 1.217,65 |
| 4" | VKVP400FDED | 1.009,33 | VKVP400FSED | 1.433,09 | VKVP400FDEFD | 1.209,94 | VKVP400FSEFD | 1.644,32 |

Válvula de bola motorizada en PVC-U 2 vías DUAL BLOCK®. Actuación neumática.

Disponemos de otras conexiones bajo pedido: bridas, encolar (BS, ASTM, JIS) y roscar (NPT, JIS). Las válvulas neumáticas se configuran NC (normalmente cerrada) de serie. La configuración NA (normalmente abierta) se debe especificar en el pedido.

VKRIV/CP

encolar.

VKRFV/CP

roscar.

ACTUACIÓN NEUMÁTICA ALUMINIO DOBLE EFECTO
CON POSICIONADOR 4-20 mAACTUACIÓN NEUMÁTICA ALUMINIO SIMPLE EFECTO
CON POSICIONADOR 4-20 mA

| d-Rh | Ref. | € EPDM | Ref. | € FKM | Ref. | € EPDM | Ref. | € FKM |
|------|--------------|-----------|--------------|----------|--------------|-----------|--------------|----------|
| 16 | VRVP016EDEPD | 2.203,53 | VRVP016FDEPD | 2.212,34 | VRVP016ESEPD | 2.234,20 | VRVP016FSEPD | 2.243,03 |
| 20 | VRVP020EDEPD | 2.205,23 | VRVP020FDEPD | 2.213,66 | VRVP020ESEPD | 2.235,92 | VRVP020FSEPD | 2.244,35 |
| 25 | VRVP025EDEPD | 2.229,18 | VRVP025FDEPD | 2.239,99 | VRVP025ESEPD | 2.259,87 | VRVP025FSEPD | 2.270,72 |
| 32 | VRVP032EDEPD | 2.267,68 | VRVP032FDEPD | 2.280,97 | VRVP032ESEPD | 2.298,39 | VRVP032FSEPD | 2.311,68 |
| 40 | VRVP040EDEPD | 2.287,92 | VRVP040FDEPD | 2.302,41 | VRVP040ESEPD | 2.318,61 | VRVP040FSEPD | 2.333,10 |
| 50 | VRVP050EDEPD | 2.363,06 | VRVP050FDEPD | 2.381,15 | VRVP050ESEPD | 2.453,41 | VRVP050FSEPD | 2.471,52 |
| 63 | VRVP063EDEPD | 2.379,85 | VRVP063FDEPD | 2.415,66 | VRVP063ESEPD | 2.549,07 | VRVP063FSEPD | 2.584,89 |

| | | | | | | | | |
|--------|--------------|----------|--------------|----------|--------------|----------|--------------|----------|
| 3/8" | VRVP038EDEPD | 2.206,78 | VRVP038FDEPD | 2.206,78 | VRVP038ESEPD | 2.237,47 | VRVP038FSEPD | 2.237,47 |
| 1/2" | VRVP012EDEPD | 2.208,92 | VRVP012FDEPD | 2.208,92 | VRVP012ESEPD | 2.239,61 | VRVP012FSEPD | 2.239,61 |
| 3/4" | VRVP034EDEPD | 2.234,17 | VRVP034FDEPD | 2.234,17 | VRVP034ESEPD | 2.264,87 | VRVP034FSEPD | 2.264,87 |
| 1" | VRVP100EDEPD | 2.272,90 | VRVP100FDEPD | 2.272,90 | VRVP100ESEPD | 2.303,60 | VRVP100FSEPD | 2.303,60 |
| 1 1/4" | VRVP114EDEPD | 2.296,16 | VRVP114FDEPD | 2.296,16 | VRVP114ESEPD | 2.326,87 | VRVP114FSEPD | 2.326,87 |
| 1 1/2" | VRVP112EDEPD | 2.375,67 | VRVP112FDEPD | 2.375,67 | VRVP112ESEPD | 2.466,03 | VRVP112FSEPD | 2.466,03 |
| 2" | VRVP200EDEPD | 2.397,22 | VRVP200FDEPD | 2.397,22 | VRVP200ESEPD | 2.566,43 | VRVP200FSEPD | 2.566,43 |

Válvula de bola **REGULACIÓN** motorizada en PVC-U 2 vías DUAL BLOCK®.

Actuación neumática con posicionador 4-20 mA.

Disponemos de otras conexiones bajo pedido: bridas, encolar (BS, ASTM, JIS) y roscar (NPT, JIS)

Las válvulas neumáticas se configuran NC (normalmente cerrada) de serie. La configuración NA (normalmente abierta) se debe especificar en el pedido.

VKRIV/CP

encolar.

VKRFV/CP

roscar.

ACTUACIÓN NEUMÁTICA POLIAMIDA DOBLE EFECTO
CON POSICIONADOR 4-20 mAACTUACIÓN NEUMÁTICA POLIAMIDA SIMPLE EFECTO
CON POSICIONADOR 4-20 mA

| d-Rh | Ref. | € EPDM | Ref. | € FKM | Ref. | € EPDM | Ref. | € FKM |
|------|--------------|-----------|--------------|----------|--------------|-----------|--------------|----------|
| 16 | VRVP016EDEPP | 1.763,82 | VRVP016FDEPP | 1.772,63 | VRVP016ESEPP | 1.786,98 | VRVP016FSEPP | 1.795,78 |
| 20 | VRVP020EDEPP | 1.765,55 | VRVP020FDEPP | 1.773,97 | VRVP020ESEPP | 1.788,70 | VRVP020FSEPP | 1.797,09 |
| 25 | VRVP025EDEPP | 1.789,50 | VRVP025FDEPP | 1.800,32 | VRVP025ESEPP | 1.812,65 | VRVP025FSEPP | 1.823,44 |
| 32 | VRVP032EDEPP | 1.827,99 | VRVP032FDEPP | 1.841,28 | VRVP032ESEPP | 1.955,23 | VRVP032FSEPP | 1.968,54 |
| 40 | VRVP040EDEPP | 1.848,21 | VRVP040FDEPP | 1.862,70 | VRVP040ESEPP | 1.975,44 | VRVP040FSEPP | 1.989,94 |
| 50 | VRVP050EDEPP | 1.923,37 | VRVP050FDEPP | 1.941,48 | VRVP050ESEPP | 2.172,06 | VRVP050FSEPP | 2.190,17 |
| 63 | VRVP063EDEPP | 2.144,23 | VRVP063FDEPP | 2.180,03 | VRVP063ESEPP | 2.210,72 | VRVP063FSEPP | 2.246,53 |

| | | | | | | | | |
|--------|--------------|----------|--------------|----------|--------------|----------|--------------|----------|
| 3/8" | VRVP038EDEPP | 1.767,07 | VRVP038FDEPP | 1.767,07 | VRVP038ESEPP | 1.790,22 | VRVP038FSEPP | 1.790,22 |
| 1/2" | VRVP012EDEPP | 1.769,21 | VRVP012FDEPP | 1.769,21 | VRVP012ESEPP | 1.792,35 | VRVP012FSEPP | 1.792,35 |
| 3/4" | VRVP034EDEPP | 1.794,47 | VRVP034FDEPP | 1.794,47 | VRVP034ESEPP | 1.817,62 | VRVP034FSEPP | 1.817,62 |
| 1" | VRVP100EDEPP | 1.833,19 | VRVP100FDEPP | 1.833,19 | VRVP100ESEPP | 1.960,43 | VRVP100FSEPP | 1.960,43 |
| 1 1/4" | VRVP114EDEPP | 1.856,45 | VRVP114FDEPP | 1.856,45 | VRVP114ESEPP | 1.983,71 | VRVP114FSEPP | 1.983,71 |
| 1 1/2" | VRVP112EDEPP | 1.935,99 | VRVP112FDEPP | 1.935,99 | VRVP112ESEPP | 2.184,68 | VRVP112FSEPP | 2.184,68 |
| 2" | VRVP200EDEPP | 2.161,59 | VRVP200FDEPP | 2.161,59 | VRVP200ESEPP | 2.228,08 | VRVP200FSEPP | 2.228,08 |

Válvula de bola **REGULACIÓN** motorizada en PVC-U 2 vías DUAL BLOCK®.

Actuación neumática con posicionador 4-20 mA.

Disponemos de otras conexiones bajo pedido: bridas, encolar (BS, ASTM, JIS) y roscar (NPT, JIS)

Las válvulas neumáticas se configuran NC (normalmente cerrada) de serie. La configuración NA (normalmente abierta) se debe especificar en el pedido.

VKDIV/CP

encolar.

VKDFV/CP

roscar.

ACTUACIÓN NEUMÁTICA POLIAMIDA

ACTUACIÓN NEUMÁTICA POLIAMIDA CON ELECTROVÁLVULA, FINALES DE CARRERA (ELECTROMECÁNICOS) Y REGULADORES DE ESCAPE



| d-Rh | DOBLE EFECTO € | | SIMPLE EFECTO € | | DOBLE EFECTO € | | SIMPLE EFECTO € | |
|------|----------------|--------|-----------------|----------|----------------|----------|-----------------|----------|
| | Ref. | | Ref. | | Ref. | | Ref. | |
| 16 | VKVP016EDEP | 307,04 | VKVP016ESEP | 330,22 | VKVP016EDEFP | 569,52 | VKVP016ESEFP | 592,66 |
| 20 | VKVP020EDEP | 308,74 | VKVP020ESEP | 331,87 | VKVP020EDEFP | 571,17 | VKVP020ESEFP | 594,31 |
| 25 | VKVP025EDEP | 319,49 | VKVP025ESEP | 342,63 | VKVP025EDEFP | 581,93 | VKVP025ESEFP | 605,07 |
| 32 | VKVP032EDEP | 332,12 | VKVP032ESEP | 459,36 | VKVP032EDEFP | 594,55 | VKVP032ESEFP | 721,80 |
| 40 | VKVP040EDEP | 354,92 | VKVP040ESEP | 482,12 | VKVP040EDEFP | 617,36 | VKVP040ESEFP | 744,59 |
| 50 | VKVP050EDEP | 377,83 | VKVP050ESEP | 626,50 | VKVP050EDEFP | 640,25 | VKVP050ESEFP | 888,97 |
| 63 | VKVP063EDEP | 610,48 | VKVP063ESEP | 677,00 | VKVP063EDEFP | 872,93 | VKVP063ESEFP | 939,41 |
| 75 | VKVP075EDEP | 791,17 | VKVP075ESEP | 1.040,33 | VKVP075EDEFP | 1.053,62 | VKVP075ESEFP | 1.302,74 |
| 90 | VKVP090EDEP | 890,95 | VKVP090ESEP | 1.140,14 | VKVP090EDEFP | 1.153,39 | VKVP090ESEFP | 1.402,55 |
| 110 | VKVP110EDEP | 942,35 | VKVP110ESEP | 1.212,75 | VKVP110EDEFP | 1.204,79 | VKVP110ESEFP | 1.475,20 |

| | | | | | | | | |
|--------|-------------|--------|-------------|----------|--------------|----------|--------------|----------|
| 3/8" | VKVP038EDEP | 310,29 | VKVP038ESEP | 333,44 | VKVP038EDEFP | 572,73 | VKVP038ESEFP | 595,89 |
| 1/2" | VKVP012EDEP | 312,48 | VKVP012ESEP | 335,60 | VKVP012EDEFP | 574,89 | VKVP012ESEFP | 598,05 |
| 3/4" | VKVP034EDEP | 324,53 | VKVP034ESEP | 347,68 | VKVP034EDEFP | 586,98 | VKVP034ESEFP | 610,12 |
| 1" | VKVP100EDEP | 337,33 | VKVP100ESEP | 464,56 | VKVP100EDEFP | 599,77 | VKVP100ESEFP | 727,03 |
| 1 1/4" | VKVP114EDEP | 363,13 | VKVP114ESEP | 490,38 | VKVP114EDEFP | 625,60 | VKVP114ESEFP | 752,83 |
| 1 1/2" | VKVP112EDEP | 390,35 | VKVP112ESEP | 639,09 | VKVP112EDEFP | 652,79 | VKVP112ESEFP | 901,51 |
| 2" | VKVP200EDEP | 627,79 | VKVP200ESEP | 694,27 | VKVP200EDEFP | 890,23 | VKVP200ESEFP | 956,72 |
| 2 1/2" | VKVP212EDEP | 820,32 | VKVP212ESEP | 1.069,48 | VKVP212EDEFP | 1.082,79 | VKVP212ESEFP | 1.331,92 |
| 3" | VKVP300EDEP | 928,06 | VKVP300ESEP | 1.177,24 | VKVP300EDEFP | 1.190,53 | VKVP300ESEFP | 1.439,66 |
| 4" | VKVP400EDEP | 984,11 | VKVP400ESEP | 1.254,52 | VKVP400EDEFP | 1.246,56 | VKVP400ESEFP | 1.516,96 |

| | | | | | | | | |
|-----|-------------|----------|-------------|----------|--------------|----------|--------------|----------|
| 16 | VKVP016FDEP | 315,90 | VKVP016FSEP | 339,06 | VKVP016FDEFP | 578,35 | VKVP016FSEFP | 601,50 |
| 20 | VKVP020FDEP | 317,22 | VKVP020FSEP | 340,36 | VKVP020FDEFP | 579,66 | VKVP020FSEFP | 602,81 |
| 25 | VKVP025FDEP | 330,37 | VKVP025FSEP | 353,55 | VKVP025FDEFP | 592,85 | VKVP025FSEFP | 615,99 |
| 32 | VKVP032FDEP | 345,41 | VKVP032FSEP | 472,65 | VKVP032FDEFP | 607,83 | VKVP032FSEFP | 735,06 |
| 40 | VKVP040FDEP | 369,41 | VKVP040FSEP | 496,65 | VKVP040FDEFP | 631,83 | VKVP040FSEFP | 759,09 |
| 50 | VKVP050FDEP | 395,93 | VKVP050FSEP | 644,63 | VKVP050FDEFP | 658,36 | VKVP050FSEFP | 907,07 |
| 63 | VKVP063FDEP | 646,22 | VKVP063FSEP | 712,74 | VKVP063FDEFP | 908,65 | VKVP063FSEFP | 975,20 |
| 75 | VKVP075FDEP | 862,96 | VKVP075FSEP | 1.112,12 | VKVP075FDEFP | 1.125,38 | VKVP075FSEFP | 1.374,54 |
| 90 | VKVP090FDEP | 978,48 | VKVP090FSEP | 1.227,64 | VKVP090FDEFP | 1.240,92 | VKVP090FSEFP | 1.490,10 |
| 110 | VKVP110FDEP | 1.063,17 | VKVP110FSEP | 1.333,57 | VKVP110FDEFP | 1.325,61 | VKVP110FSEFP | 1.596,04 |

| | | | | | | | | |
|--------|-------------|----------|-------------|----------|--------------|----------|--------------|----------|
| 3/8" | VKVP038FDEP | 319,69 | VKVP038FSEP | 342,81 | VKVP038FDEFP | 582,14 | VKVP038FSEFP | 605,26 |
| 1/2" | VKVP012FDEP | 321,67 | VKVP012FSEP | 344,82 | VKVP012FDEFP | 584,11 | VKVP012FSEFP | 607,27 |
| 3/4" | VKVP034FDEP | 333,49 | VKVP034FSEP | 356,64 | VKVP034FDEFP | 595,91 | VKVP034FSEFP | 619,06 |
| 1" | VKVP100FDEP | 355,20 | VKVP100FSEP | 482,43 | VKVP100FDEFP | 617,64 | VKVP100FSEFP | 744,88 |
| 1 1/4" | VKVP114FDEP | 377,96 | VKVP114FSEP | 505,19 | VKVP114FDEFP | 640,38 | VKVP114FSEFP | 767,64 |
| 1 1/2" | VKVP112FDEP | 409,04 | VKVP112FSEP | 657,74 | VKVP112FDEFP | 671,49 | VKVP112FSEFP | 920,18 |
| 2" | VKVP200FDEP | 664,84 | VKVP200FSEP | 731,35 | VKVP200FDEFP | 927,29 | VKVP200FSEFP | 993,80 |
| 2 1/2" | VKVP212FDEP | 892,11 | VKVP212FSEP | 1.141,24 | VKVP212FDEFP | 1.154,56 | VKVP212FSEFP | 1.403,68 |
| 3" | VKVP300FDEP | 1.015,68 | VKVP300FSEP | 1.264,82 | VKVP300FDEFP | 1.278,13 | VKVP300FSEFP | 1.527,26 |
| 4" | VKVP400FDEP | 1.104,96 | VKVP400FSEP | 1.375,36 | VKVP400FDEFP | 1.367,38 | VKVP400FSEFP | 1.637,80 |

Válvula de bola motorizada en PVC-U 2 vías DUAL BLOCK®. Actuación neumática.

Disponemos de otras conexiones bajo pedido: bridas, encolar (BS, ASTM, JIS) y roscar (NPT, JIS). Las válvulas neumáticas se configuran NC (normalmente cerrada) de serie. La configuración NA (normalmente abierta) se debe especificar en el pedido.



INDUSTRIA

Válvulas motorizadas de PVC-U presión

Válvulas de 3 vías actuadas



LKDIV/CE
encolar.

LKDFV/CE
roscar.

ACTUACIÓN ELÉCTRICA

ACTUACIÓN ELÉCTRICA CON BLOQUE DE SEGURIDAD

| d-Rh | 24-240 V AC/DC | | 24-240 V AC/DC | | 24-240 V AC/DC | | 24-240 V AC/DC | |
|--------|----------------|--------|----------------|----------|----------------|----------|----------------|----------|
| | Ref. | € | Ref. | € | Ref. | € | Ref. | € |
| 16 | LKVE016E2D | 699,89 | LKVE016F2D | 714,97 | LKVE016E2BD | 1.254,59 | LKVE016F2BD | 1.269,63 |
| 20 | LKVE020E2D | 702,31 | LKVE020F2D | 717,65 | LKVE020E2BD | 1.256,99 | LKVE020F2BD | 1.272,36 |
| 25 | LKVE025E2D | 723,78 | LKVE025F2D | 744,31 | LKVE025E2BD | 1.278,49 | LKVE025F2BD | 1.298,96 |
| 32 | LKVE032E2D | 756,57 | LKVE032F2D | 781,98 | LKVE032E2BD | 1.311,22 | LKVE032F2BD | 1.336,68 |
| 40 | LKVE040E2D | 798,77 | LKVE040F2D | 835,62 | LKVE040E2BD | 1.353,47 | LKVE040F2BD | 1.390,29 |
| 50 | LKVE050E2D | 841,33 | LKVE050F2D | 903,10 | LKVE050E2BD | 1.396,04 | LKVE050F2BD | 1.457,76 |
| 63 | LKVE063E2D | 909,57 | LKVE063F2D | 987,54 | LKVE063E2BD | 1.464,25 | LKVE063F2BD | 1.542,22 |
| 3/8" | LKVE038E2D | 710,42 | LKVE038F2D | 725,51 | LKVE038E2BD | 1.265,13 | LKVE038F2BD | 1.280,17 |
| 1/2" | LKVE012E2D | 713,02 | LKVE012F2D | 728,45 | LKVE012E2BD | 1.267,70 | LKVE012F2BD | 1.283,10 |
| 3/4" | LKVE034E2D | 736,17 | LKVE034F2D | 756,69 | LKVE034E2BD | 1.290,85 | LKVE034F2BD | 1.311,38 |
| 1" | LKVE100E2D | 771,88 | LKVE100F2D | 797,32 | LKVE100E2BD | 1.326,57 | LKVE100F2BD | 1.352,03 |
| 1 1/4" | LKVE114E2D | 817,41 | LKVE114F2D | 854,18 | LKVE114E2BD | 1.372,09 | LKVE114F2BD | 1.408,86 |
| 1 1/2" | LKVE112E2D | 863,81 | LKVE112F2D | 925,61 | LKVE112E2BD | 1.418,46 | LKVE112F2BD | 1.480,30 |
| 2" | LKVE200E2D | 937,95 | LKVE200F2D | 1.015,87 | LKVE200E2BD | 1.492,62 | LKVE200F2BD | 1.570,54 |

Válvula de bola motorizada en PVC-U 3 vías DUAL BLOCK®. Actuación eléctrica.

Estándar paso en L, paso en T opcional, al mismo precio. Bajo pedido podemos suministrar otros actuadores: VALPES, BELIMO... Disponemos de otras conexiones bajo pedido: bridas, encolar (BS, ASTM, JIS) y roscar (NPT, JIS).
Bajo pedido también disponibles en 12V AC/DC



| Medida | Ref. EPDM | DN | PN | € |
|--------|-----------|-----|----|----------|
| 140 | 63072 | 125 | 10 | 1.794,64 |

Válvula Ø 140 con actuador neumático.
Brida.

| Medida | Ref. EPDM | DN | PN | € |
|--------|-----------|-----|----|----------|
| 140 | 63073 | 125 | 10 | 2.807,94 |

Válvula Ø 140 con actuador eléctrico.
Brida.

LKDIV/CP

encolar.

LKDFV/CP

roscar.

ACTUACIÓN NEUMÁTICA ALUMINIO

ACTUACIÓN NEUMÁTICA ALUMINIO CON ELECTROVÁLVULA, FINALES DE CARRERA (ELECTROMECAÑICOS) Y REGULADORES DE ESCAPE



| | d-Rh | DOBLE EFECTO € | | SIMPLE EFECTO € | | DOBLE EFECTO € | | SIMPLE EFECTO € | |
|---------|--------|----------------|--------|-----------------|--------|----------------|--------|-----------------|----------|
| | | Ref. | Ref. | Ref. | Ref. | Ref. | Ref. | Ref. | Ref. |
| ENCOLAR | 16 | LKVP016EDED | 393,31 | LKVP016ESED | 393,23 | LKVP016EDEFD | 563,15 | LKVP016ESEFD | 604,46 |
| | 20 | LKVP020EDED | 364,93 | LKVP020ESED | 395,65 | LKVP020EDEFD | 565,57 | LKVP020ESEFD | 606,86 |
| | 25 | LKVP025EDED | 386,44 | LKVP025ESED | 417,13 | LKVP025EDEFD | 587,03 | LKVP025ESEFD | 628,35 |
| | 32 | LKVP032EDED | 419,19 | LKVP032ESED | 449,90 | LKVP032EDEFD | 619,83 | LKVP032ESEFD | 661,11 |
| | 40 | LKVP040EDED | 461,39 | LKVP040ESED | 551,75 | LKVP040EDEFD | 662,01 | LKVP040ESEFD | 762,97 |
| ROSCAR | 50 | LKVP050EDED | 539,72 | LKVP050ESED | 673,21 | LKVP050EDEFD | 740,36 | LKVP050ESEFD | 884,41 |
| | 63 | LKVP063EDED | 607,96 | LKVP063ESED | 741,42 | LKVP063EDEFD | 808,58 | LKVP063ESEFD | 952,65 |
| ENCOLAR | 3/8" | LKVP038EDED | 373,05 | LKVP038ESED | 403,76 | LKVP038EDEFD | 573,69 | LKVP038ESEFD | 614,99 |
| | 1/2" | LKVP012EDED | 375,64 | LKVP012ESED | 406,37 | LKVP012EDEFD | 576,26 | LKVP012ESEFD | 617,57 |
| | 3/4" | LKVP034EDED | 398,76 | LKVP034ESED | 429,51 | LKVP034EDEFD | 599,41 | LKVP034ESEFD | 640,71 |
| | 1" | LKVP100EDED | 434,56 | LKVP100ESED | 465,25 | LKVP100EDEFD | 635,18 | LKVP100ESEFD | 676,48 |
| | 1 1/4" | LKVP114EDED | 685,35 | LKVP114ESED | 570,39 | LKVP114EDEFD | 680,65 | LKVP114ESEFD | 781,62 |
| ROSCAR | 1 1/2" | LKVP112EDED | 562,20 | LKVP112ESED | 695,66 | LKVP112EDEFD | 762,80 | LKVP112ESEFD | 906,86 |
| | 2" | LKVP200EDED | 636,31 | LKVP200ESED | 769,82 | LKVP200EDEFD | 836,96 | LKVP200ESEFD | 981,02 |
| ENCOLAR | 16 | LKVP016FDED | 377,60 | LKVP016FSED | 408,32 | LKVP016FDEFD | 578,22 | LKVP016FSEFD | 619,52 |
| | 20 | LKVP020FDED | 380,28 | LKVP020FSED | 411,00 | LKVP020FDEFD | 580,92 | LKVP020FSEFD | 622,22 |
| | 25 | LKVP025FDED | 406,93 | LKVP025FSED | 437,63 | LKVP025FDEFD | 607,58 | LKVP025FSEFD | 648,85 |
| | 32 | LKVP032FDED | 444,63 | LKVP032FSED | 475,32 | LKVP032FDEFD | 645,24 | LKVP032FSEFD | 686,55 |
| | 40 | LKVP040FDED | 498,26 | LKVP040FSED | 588,59 | LKVP040FDEFD | 698,91 | LKVP040FSEFD | 799,85 |
| ROSCAR | 50 | LKVP050FDED | 601,50 | LKVP050FSED | 734,96 | LKVP050FDEFD | 802,09 | LKVP050FSEFD | 946,19 |
| | 63 | LKVP063FDED | 685,91 | LKVP063FSED | 819,40 | LKVP063FDEFD | 886,55 | LKVP063FSEFD | 1.030,65 |
| ENCOLAR | 3/8" | LKVP038FDED | 388,13 | LKVP038FSED | 418,85 | LKVP038FDEFD | 588,75 | LKVP038FSEFD | 630,08 |
| | 1/2" | LKVP012FDED | 391,04 | LKVP012FSED | 421,73 | LKVP012FDEFD | 591,68 | LKVP012FSEFD | 632,99 |
| | 3/4" | LKVP034FDED | 419,29 | LKVP034FSED | 450,01 | LKVP034FDEFD | 619,94 | LKVP034FSEFD | 661,21 |
| | 1" | LKVP100FDED | 459,98 | LKVP100FSED | 490,69 | LKVP100FDEFD | 660,59 | LKVP100FSEFD | 701,89 |
| | 1 1/4" | LKVP114FDED | 737,89 | LKVP114FSED | 607,16 | LKVP114FDEFD | 717,43 | LKVP114FSEFD | 818,37 |
| ROSCAR | 1 1/2" | LKVP112FDED | 624,00 | LKVP112FSED | 757,49 | LKVP112FDEFD | 824,62 | LKVP112FSEFD | 968,69 |
| | 2" | LKVP200FDED | 714,23 | LKVP200FSED | 847,72 | LKVP200FDEFD | 914,85 | LKVP200FSEFD | 1.058,92 |

Válvula de bola motorizada en PVC-U 3 vías DUAL BLOCK®.

Actuación neumática.

Estándar paso en L, paso en T opcional, al mismo precio. Disponemos de otras conexiones bajo pedido: bridas, encolar (BS, ASTM, JIS) y roscar (NPT, JIS). Las válvulas neumáticas se configuran NC (normalmente cerrada) de serie. La configuración NA (normalmente abierta) se debe especificar en el pedido.

LKDIV/CP

encolar.

LKDFV/CP

roscar.

ACTUACIÓN NEUMÁTICA POLIAMIDA

ACTUACIÓN NEUMÁTICA POLIAMIDA CON ELECTROVÁLVULA, FINALES DE CARRERA (ELECTROMECÁNICOS) Y REGULADORES DE ESCAPE



| d-Rh | DOBLE EFECTO € | | SIMPLE EFECTO € | | DOBLE EFECTO € | | SIMPLE EFECTO € | |
|------|----------------|--------|-----------------|--------|----------------|----------|-----------------|----------|
| | Ref. | Ref. | Ref. | Ref. | Ref. | Ref. | Ref. | |
| 16 | LKVP016EDEP | 420,68 | LKVP016ESEP | 443,83 | LKVP016EDEFP | 683,13 | LKVP016ESEFP | 706,27 |
| 20 | LKVP020EDEP | 423,07 | LKVP020ESEP | 446,23 | LKVP020EDEFP | 685,52 | LKVP020ESEFP | 708,69 |
| 25 | LKVP025EDEP | 489,77 | LKVP025ESEP | 512,92 | LKVP025EDEFP | 752,21 | LKVP025ESEFP | 775,33 |
| 32 | LKVP032EDEP | 522,52 | LKVP032ESEP | 649,75 | LKVP032EDEFP | 784,99 | LKVP032ESEFP | 912,22 |
| 40 | LKVP040EDEP | 579,66 | LKVP040ESEP | 828,33 | LKVP040EDEFP | 842,11 | LKVP040ESEFP | 1.090,77 |
| 50 | LKVP050EDEP | 715,21 | LKVP050ESEP | 868,42 | LKVP050EDEFP | 977,62 | LKVP050ESEFP | 1.130,89 |
| 63 | LKVP063EDEP | 859,57 | LKVP063ESEP | 926,07 | LKVP063EDEFP | 1.122,01 | LKVP063ESEFP | 1.188,52 |

| | | | | | | | | |
|--------|-------------|--------|-------------|--------|--------------|----------|--------------|----------|
| 3/8" | LKVP038EDEP | 431,24 | LKVP038ESEP | 454,36 | LKVP038EDEFP | 693,65 | LKVP038ESEFP | 716,78 |
| 1/2" | LKVP012EDEP | 433,82 | LKVP012ESEP | 456,94 | LKVP012EDEFP | 696,23 | LKVP012ESEFP | 719,38 |
| 3/4" | LKVP034EDEP | 502,16 | LKVP034ESEP | 525,28 | LKVP034EDEFP | 764,57 | LKVP034ESEFP | 787,72 |
| 1" | LKVP100EDEP | 537,90 | LKVP100ESEP | 665,12 | LKVP100EDEFP | 800,34 | LKVP100ESEFP | 927,57 |
| 1 1/4" | LKVP114EDEP | 598,25 | LKVP114ESEP | 846,97 | LKVP114EDEFP | 860,70 | LKVP114ESEFP | 1.109,39 |
| 1 1/2" | LKVP112EDEP | 737,67 | LKVP112ESEP | 890,90 | LKVP112EDEFP | 1.000,11 | LKVP112ESEFP | 1.153,34 |
| 2" | LKVP200EDEP | 887,91 | LKVP200ESEP | 954,43 | LKVP200EDEFP | 1.150,39 | LKVP200ESEFP | 1.216,87 |

| | | | | | | | | |
|----|-------------|--------|-------------|----------|--------------|----------|--------------|----------|
| 16 | LKVP016FDEP | 435,74 | LKVP016FSEP | 458,90 | LKVP016FDEFP | 698,19 | LKVP016FSEFP | 721,34 |
| 20 | LKVP020FDEP | 438,45 | LKVP020FSEP | 461,59 | LKVP020FDEFP | 700,86 | LKVP020FSEFP | 724,04 |
| 25 | LKVP025FDEP | 510,26 | LKVP025FSEP | 533,42 | LKVP025FDEFP | 772,71 | LKVP025FSEFP | 795,86 |
| 32 | LKVP032FDEP | 547,96 | LKVP032FSEP | 675,20 | LKVP032FDEFP | 810,43 | LKVP032FSEFP | 937,66 |
| 40 | LKVP040FDEP | 616,49 | LKVP040FSEP | 865,20 | LKVP040FDEFP | 878,95 | LKVP040FSEFP | 1.127,62 |
| 50 | LKVP050FDEP | 776,96 | LKVP050FSEP | 930,22 | LKVP050FDEFP | 1.039,40 | LKVP050FSEFP | 1.192,64 |
| 63 | LKVP063FDEP | 937,56 | LKVP063FSEP | 1.004,04 | LKVP063FDEFP | 1.200,00 | LKVP063FSEFP | 1.266,49 |

| | | | | | | | | |
|--------|-------------|--------|-------------|----------|--------------|----------|--------------|----------|
| 3/8" | LKVP038FDEP | 446,28 | LKVP038FSEP | 469,40 | LKVP038FDEFP | 708,72 | LKVP038FSEFP | 731,87 |
| 1/2" | LKVP012FDEP | 449,21 | LKVP012FSEP | 472,36 | LKVP012FDEFP | 711,66 | LKVP012FSEFP | 734,80 |
| 3/4" | LKVP034FDEP | 522,65 | LKVP034FSEP | 545,80 | LKVP034FDEFP | 785,10 | LKVP034FSEFP | 808,24 |
| 1" | LKVP100FDEP | 563,34 | LKVP100FSEP | 690,56 | LKVP100FDEFP | 825,75 | LKVP100FSEFP | 953,01 |
| 1 1/4" | LKVP114FDEP | 635,05 | LKVP114FSEP | 883,74 | LKVP114FDEFP | 897,47 | LKVP114FSEFP | 1.146,16 |
| 1 1/2" | LKVP112FDEP | 799,49 | LKVP112FSEP | 952,70 | LKVP112FDEFP | 1.061,91 | LKVP112FSEFP | 1.215,17 |
| 2" | LKVP200FDEP | 965,83 | LKVP200FSEP | 1.032,37 | LKVP200FDEFP | 1.228,28 | LKVP200FSEFP | 1.294,79 |

Válvula de bola motorizada en PVC-U 3 vías DUAL BLOCK®.

Actuación neumática.

Estándar paso en L, paso en T opcional, al mismo precio. Disponemos de otras conexiones bajo pedido: bridas, encolar (BS, ASTM, JIS) y roscar (NPT, JIS).

Las válvulas neumáticas se configuran NC (normalmente cerrada) de serie. La configuración NA (normalmente abierta) se debe especificar en el pedido.

**FEOV/CE**

ACTUACIÓN ELÉCTRICA

ACTUACIÓN ELÉCTRICA CON BLOQUE DE SEGURIDAD

| d | 24-240 V AC/DC | | 24-240 V AC/DC | | 24-240 V AC/DC | | 24-240 V AC/DC | |
|----------|----------------|-----------|----------------|----------|----------------|-----------|----------------|----------|
| | Ref. | € EPDM | Ref. | € FKM | Ref. | € EPDM | Ref. | € FKM |
| 50 | FEVE050E2D | 666,18 | FEVE050F2D | 764,31 | FEVE050E2BD | 1.220,84 | FEVE050F2BD | 1.318,97 |
| 63 | FEVE063E2D | 671,90 | FEVE063F2D | 776,21 | FEVE063E2BD | 1.226,55 | FEVE063F2BD | 1.330,89 |
| 75 | FEVE075E2D | 936,06 | FEVE075F2D | 1.038,60 | FEVE075E2BD | 1.490,72 | FEVE075F2BD | 1.593,26 |
| 90 | FEVE090E2D | 951,93 | FEVE090F2D | 1.087,35 | FEVE090E2BD | 1.506,58 | FEVE090F2BD | 1.642,03 |
| 110 | FEVE110E2D | 973,50 | FEVE110F2D | 1.150,15 | FEVE110E2BD | 1.528,19 | FEVE110F2BD | 1.704,84 |
| 125 (A1) | FEVE140E2D | 1.364,39 | FEVE140F2D | 1.620,65 | FEVE140E2BD | 1.919,10 | FEVE140F2BD | 2.175,34 |
| 140 | FEVE140E2D | 1.364,39 | FEVE140F2D | 1.620,65 | FEVE140E2BD | 1.919,10 | FEVE140F2BD | 2.175,34 |
| 160 | FEVE160E2D | 1.650,21 | FEVE160F2D | 2.057,82 | FEVE160E2BD | 2.299,30 | FEVE160F2BD | 2.706,92 |
| 200*(A2) | FEVE225E2D | 1.936,53 | FEVE225F2D | 2.464,31 | FEVE225E2BD | 2.585,64 | FEVE225F2BD | 3.113,38 |
| 225* | FEVE225E2D | 1.936,53 | FEVE225F2D | 2.464,31 | FEVE225E2BD | 2.585,64 | FEVE225F2BD | 3.113,38 |
| 250*(A3) | FEVE280E2D | 2.750,82 | | | FEVE280E2BD | 3.399,91 | | |
| 280 | FEVE280E2D | 2.750,82 | | | FEVE280E2BD | 3.399,91 | | |
| 315 | FEVE315E2D | 3.022,02 | | | FEVE315E2BD | 3.671,11 | | |

Válvula de mariposa motorizada en PVC-U.

Actuación eléctrica.

(A1) = a utilizar con portabridas QPV especial no incluido (transforma la válvula de mariposa de 140 en 125)

(A2) = a utilizar con portabridas QPV especial no incluido (transforma la válvula de mariposa de 225 en 200)

(A3)= a utilizar con tubo de diámetro 250 SDR 26 (PN10).

Bajo pedido podemos suministrar otros actuadores: VALPES, BELIMO... [Bajo pedido también disponibles en 12V AC/DC](#)



FEOV/CP

ACTUACIÓN NEUMÁTICA ALUMINIO

ACTUACIÓN NEUMÁTICA ALUMINIO CON ELECTROVÁLVULA, FINALES DE CARRERA (ELECTROMECAÑICOS) Y REGULADORES DE ESCAPE

| d | DOBLE EFECTO | | SIMPLE EFECTO | | DOBLE EFECTO | | SIMPLE EFECTO | |
|----------|--------------|----------|---------------|----------|--------------|----------|---------------|----------|
| | Ref. | € | Ref. | € | Ref. | € | Ref. | € |
| 50 | FEVP050EDED | 328,45 | FEVP050ESED | 418,80 | FEVP050EDEFD | 529,11 | FEVP050ESEFD | 630,00 |
| 63 | FEVP063EDED | 334,16 | FEVP063ESED | 424,55 | FEVP063EDEFD | 534,78 | FEVP063ESEFD | 635,77 |
| 75 | FEVP075EDED | 374,46 | FEVP075ESED | 507,94 | FEVP075EDEFD | 575,05 | FEVP075ESEFD | 719,15 |
| 90 | FEVP090EDED | 452,87 | FEVP090ESED | 572,61 | FEVP090EDEFD | 653,51 | FEVP090ESEFD | 783,83 |
| 110 | FEVP110EDED | 474,47 | FEVP110ESED | 925,23 | FEVP110EDEFD | 675,11 | FEVP110ESEFD | 1.136,45 |
| 125 (A1) | FEVP140EDED | 532,23 | FEVP140ESED | 1.209,61 | FEVP140EDEFD | 732,82 | FEVP140ESEFD | 1.420,83 |
| 140 | FEVP140EDED | 532,23 | FEVP140ESED | 1.209,61 | FEVP140EDEFD | 732,82 | FEVP140ESEFD | 1.420,83 |
| 160 | FEVP160EDED | 576,08 | FEVP160ESED | 1.253,49 | FEVP160EDEFD | 776,72 | FEVP160ESEFD | 1.464,71 |
| 200 (A2) | FEVP225EDED | 1.001,37 | FEVP225ESED | 1.931,04 | FEVP225EDEFD | 1.201,99 | FEVP225ESEFD | 2.142,28 |
| 225 | FEVP225EDED | 1.001,37 | FEVP225ESED | 1.931,04 | FEVP225EDEFD | 1.201,99 | FEVP225ESEFD | 2.142,28 |
| 250 (A3) | FEVP280EDED | 1.996,53 | FEVP280ESED | 3.967,49 | FEVP280EDEFD | 2.197,18 | FEVP280ESEFD | 4.178,74 |
| 280 | FEVP280EDED | 1.996,53 | FEVP280ESED | 3.967,49 | FEVP280EDEFD | 2.197,18 | FEVP280ESEFD | 4.178,74 |
| 315 | FEVP315EDED | 2.535,81 | FEVP315ESED | 5.256,91 | FEVP315EDEFD | 2.736,40 | FEVP315ESEFD | 5.468,15 |

| | | | | | | | | |
|----------|-------------|----------|-------------|----------|--------------|----------|--------------|----------|
| 50 | FEVP050FDED | 426,57 | FEVP050FSED | 516,94 | FEVP050FDEFD | 627,22 | FEVP050FSEFD | 728,16 |
| 63 | FEVP063FDED | 438,50 | FEVP063FSED | 528,83 | FEVP063FDEFD | 639,15 | FEVP063FSEFD | 740,06 |
| 75 | FEVP075FDED | 476,99 | FEVP075FSED | 610,48 | FEVP075FDEFD | 677,64 | FEVP075FSEFD | 821,68 |
| 90 | FEVP090FDED | 588,28 | FEVP090FSED | 708,05 | FEVP090FDEFD | 788,93 | FEVP090FSEFD | 919,25 |
| 110 | FEVP110FDED | 651,09 | FEVP110FSED | 1.101,84 | FEVP110FDEFD | 851,74 | FEVP110FSEFD | 1.313,07 |
| 125 (A1) | FEVP140FDED | 788,50 | FEVP140FSED | 1.465,88 | FEVP140FDEFD | 989,09 | FEVP140FSEFD | 1.677,10 |
| 140 | FEVP140FDED | 788,50 | FEVP140FSED | 1.465,88 | FEVP140FDEFD | 989,09 | FEVP140FSEFD | 1.677,10 |
| 160 | FEVP160FDED | 983,73 | FEVP160FSED | 1.661,11 | FEVP160FDEFD | 1.184,35 | FEVP160FSEFD | 1.872,33 |
| 200 (A2) | FEVP225FDED | 1.529,09 | FEVP225FSED | 2.458,80 | FEVP225FDEFD | 1.729,73 | FEVP225FSEFD | 2.670,02 |
| 225 | FEVP225FDE | 2.183,16 | FEVP225FSED | 2.458,80 | FEVP225FDEFD | 1.729,73 | FEVP225FSEFD | 2.670,02 |

Válvula de mariposa motorizada en PVC-U.

Actuación neumática.

(A1) = a utilizar con portabridas QPV especial no incluido (transforma la válvula de mariposa de 140 en 125)

(A2) = a utilizar con portabridas QPV especial no incluido (transforma la válvula de mariposa de 225 en 200)

(A3) = a utilizar con tubo de diámetro 250 SDR 26 (PN10)

Las válvulas neumáticas se configuran NC (normalmente cerrada) de serie. La configuración NA (normalmente abierta) se debe especificar en el pedido.



FEOV/CP

ACTUACIÓN NEUMÁTICA POLIAMIDA

ACTUACIÓN NEUMÁTICA POLIAMIDA CON ELECTROVÁLVULA, FINALES DE CARRERA (ELECTROMECAÑICOS) Y REGULADORES DE ESCAPE

| d | DOBLE EFECTO | | SIMPLE EFECTO | | DOBLE EFECTO | | SIMPLE EFECTO | |
|----------|--------------|----------|---------------|----------|--------------|----------|---------------|----------|
| | Ref. | € | Ref. | € | Ref. | € | Ref. | € |
| 50 | FEVP050EDEP | 435,41 | FEVP050ESEP | 598,56 | FEVP050EDEFP | 697,83 | FEVP050ESEFP | 860,98 |
| 63 | FEVP063EDEP | 441,13 | FEVP063ESEP | 604,28 | FEVP063EDEFP | 703,57 | FEVP063ESEFP | 866,72 |
| 75 | FEVP075EDEP | 445,68 | FEVP075ESEP | 608,81 | FEVP075EDEFP | 708,10 | FEVP075ESEFP | 871,26 |
| 90 | FEVP090EDEP | 557,83 | FEVP090ESEP | 624,33 | FEVP090EDEFP | 820,27 | FEVP090ESEFP | 886,76 |
| 110 | FEVP110EDEP | 579,43 | FEVP110ESEP | 841,18 | FEVP110EDEFP | 841,87 | FEVP110ESEFP | 1.103,65 |
| 125 (A1) | FEVP140EDEP | 595,89 | FEVP140ESEP | 1.157,77 | FEVP140EDEFP | 858,33 | FEVP140ESEFP | 1.420,22 |
| 140 | FEVP140EDEP | 595,89 | FEVP140ESEP | 1.157,77 | FEVP140EDEFP | 858,33 | FEVP140ESEFP | 1.420,22 |
| 160 | FEVP160EDEP | 823,36 | FEVP160ESEP | 1.201,63 | FEVP160EDEFP | 1.085,77 | FEVP160ESEFP | 1.464,07 |
| 200 (A2) | FEVP225EDEP | 982,72 | FEVP225ESEP | 1.763,41 | FEVP225EDEFP | 1.245,15 | FEVP225ESEFP | 2.025,89 |
| 225 | FEVP225EDEP | 982,72 | FEVP225ESEP | 1.763,41 | FEVP225EDEFP | 1.245,15 | FEVP225ESEFP | 2.025,89 |
| 250*(A3) | FEVP280EDEP | 2.175,24 | FEVP280ESEP | 3.848,73 | FEVP280EDEFP | 2.437,63 | FEVP280ESEFP | 4.111,19 |
| 280* | FEVP280EDEP | 2.175,24 | FEVP280ESEP | 3.848,73 | FEVP280EDEFP | 2.437,63 | FEVP280ESEFP | 4.111,19 |
| 315* | FEVP315EDEP | 2.446,40 | FEVP315ESEP | 4.119,95 | FEVP315EDEFP | 2.708,88 | FEVP315ESEFP | 4.382,37 |

| | | | | | | | | |
|----------|-------------|----------|-------------|----------|--------------|----------|--------------|----------|
| 50 | FEVP050FDEP | 533,54 | FEVP050FSEP | 696,69 | FEVP050FDEFP | 795,96 | FEVP050FSEFP | 959,14 |
| 63 | FEVP063FDEP | 545,47 | FEVP063FSEP | 708,62 | FEVP063FDEFP | 807,91 | FEVP063FSEFP | 971,06 |
| 75 | FEVP075FDEP | 548,20 | FEVP075FSEP | 711,35 | FEVP075FDEFP | 810,64 | FEVP075FSEFP | 973,81 |
| 90 | FEVP090FDEP | 693,27 | FEVP090FSEP | 759,78 | FEVP090FDEFP | 955,72 | FEVP090FSEFP | 1.022,20 |
| 110 | FEVP110FDEP | 756,02 | FEVP110FSEP | 1.017,79 | FEVP110FDEFP | 1.018,49 | FEVP110FSEFP | 1.280,24 |
| 125 (A1) | FEVP140FDEP | 852,12 | FEVP140FSEP | 1.414,01 | FEVP140FDEFP | 1.114,56 | FEVP140FSEFP | 1.676,46 |
| 140 | FEVP140FDEP | 852,12 | FEVP140FSEP | 1.414,01 | FEVP140FDEFP | 1.114,56 | FEVP140FSEFP | 1.676,46 |
| 160 | FEVP160FDEP | 1.230,95 | FEVP160FSEP | 1.609,27 | FEVP160FDEFP | 1.493,43 | FEVP160FSEFP | 1.871,72 |
| 200 (A2) | FEVP225FDEP | 1.510,47 | FEVP225FSEP | 2.291,16 | FEVP225FDEFP | 1.772,92 | FEVP225FSEFP | 2.553,61 |
| 225 | FEVP225FDEP | 1.510,47 | FEVP225FSEP | 2.291,16 | FEVP225FDEFP | 1.772,92 | FEVP225FSEFP | 2.553,61 |

Válvula de mariposa motorizada en PVC-U.

Actuación neumática.

(A1) = a utilizar con portabridas QPV especial no incluido (transforma la válvula de mariposa de 140 en 125)

(A2) = a utilizar con portabridas QPV especial no incluido (transforma la válvula de mariposa de 225 en 200)

(A3)= a utilizar con tubo de diámetro 250 SDR 26 (PN10) * Actuadores de aluminio

Las válvulas neumáticas se configuran NC (normalmente cerrada) de serie. La configuración NA (normalmente abierta) se debe especificar en el pedido.



FKOV/CE

ACTUACIÓN ELÉCTRICA

ACTUACIÓN ELÉCTRICA CON BLOQUE DE SEGURIDAD

| d | 24-240 V AC/DC | | 24-240 V AC/DC | | 24-240 V AC/DC | | 24-240 V AC/DC | |
|----------|----------------|-----------|----------------|-----------|----------------|----------|----------------|----------|
| | Ref. | € | Ref. | € | Ref. | € | Ref. | € |
| 50 | FKVE050E2D | 845,01 | FKVE050F2D | 1.011,59 | FKVE050E2BD | 1.399,70 | FKVE050F2BD | 1.566,30 |
| 63 | FKVE063E2D | 862,42 | FKVE063F2D | 1.038,81 | FKVE063E2BD | 1.417,10 | FKVE063F2BD | 1.593,51 |
| 75 | FKVE075E2D | 1.156,90 | FKVE075F2D | 1.352,91 | FKVE075E2BD | 1.711,58 | FKVE075F2BD | 1.907,54 |
| 90 | FKVE090E2D | 1.187,44 | FKVE090F2D | 1.392,15 | FKVE090E2BD | 1.742,12 | FKVE090F2BD | 1.946,78 |
| 110 | FKVE110E2D | 1.219,26 | FKVE110F2D | 1.440,02 | FKVE110E2BD | 1.773,97 | FKVE110F2BD | 1.994,68 |
| 125 (A1) | FKVE140E2D | 1.720,23 | FKVE140F2D | 2.019,32 | FKVE140E2BD | 2.274,89 | FKVE140F2BD | 2.574,02 |
| 140 | FKVE140E2D | 1.720,23 | FKVE140F2D | 2.019,32 | FKVE140E2BD | 2.274,89 | FKVE140F2BD | 2.574,02 |
| 160 | FKVE160E2D | 2.020,24 | FKVE160F2D | 2.329,48 | FKVE160E2BD | 2.669,33 | FKVE160F2BD | 2.978,55 |
| 200(A2) | FKVE225E2D | 2.341,24 | FKVE225F2D | 2.744,88 | FKVE225E2BD | 2.990,33 | FKVE225F2BD | 3.393,98 |
| 225 | FKVE225E2D | 2.341,24 | FKVE225F2D | 2.744,88 | FKVE225E2BD | 2.990,33 | FKVE225F2BD | 3.393,98 |
| 250(A3) | FKVE280E2D | 4.125,05 | FKVE280F2D | 5.818,24 | FKVE280E2BD | 4.774,13 | FKVE280F2BD | 6.467,32 |
| 280 | FKVE280E2D | 4.125,05 | FKVE280F2D | 5.818,24 | FKVE280E2BD | 4.774,13 | FKVE280F2BD | 6.467,32 |
| 315 | FKVE315E2D | 4.350,15 | FKVE315F2D | 6.195,84 | FKVE315E2BD | 4.999,24 | FKVE315F2BD | 6.844,92 |
| 355 | FKVE355E2D | 11.017,40 | FKVE355F2D | 14.976,49 | | | | |
| 400 | FKVE400E2D | 12.210,55 | FKVE400F2D | 17.929,76 | | | | |

Válvula de mariposa industrial motorizada.

Cuerpo en PPGR y disco en PVC-U.

Actuación eléctrica.

(A1) = a utilizar con portabridas QPV especial no incluido (transforma la válvula de mariposa de 140 en 125)

(A2) = a utilizar con portabridas QPV especial no incluido (transforma la válvula de mariposa de 225 en 200)

(A3) = a utilizar con tubo de diámetro 250 SDR 26 (PN10)

Bajo pedido podemos suministrar otros actuadores: VALPES, BELIMO...

Bajo pedido también disponibles en 12V AC/DC



FKOV/CP

ACTUACIÓN NEUMÁTICA ALUMINIO

ACTUACIÓN NEUMÁTICA ALUMINIO CON ELECTROVÁLVULA, FINALES DE CARRERA (ELECTROMECAÑICOS) Y REGULADORES DE ESCAPE

| d | DOBLE EFECTO | | SIMPLE EFECTO | | DOBLE EFECTO | | SIMPLE EFECTO | |
|----------|--------------|----------|---------------|-----------|--------------|----------|---------------|----------|
| | Ref. | € | Ref. | € | Ref. | € | Ref. | € |
| 50 | FKVP050EDED | 507,31 | FKVP050ESED | 597,64 | FKVP050EDEFD | 707,92 | FKVP050ESEFD | 808,89 |
| 63 | FKVP063EDED | 524,73 | FKVP063ESED | 615,06 | FKVP063EDEFD | 725,36 | FKVP063ESEFD | 826,30 |
| 75 | FKVP075EDED | 595,29 | FKVP075ESED | 728,78 | FKVP075EDEFD | 795,91 | FKVP075ESEFD | 939,98 |
| 90 | FKVP090EDED | 688,38 | FKVP090ESED | 808,12 | FKVP090EDEFD | 889,02 | FKVP090ESEFD | 1.019,37 |
| 110 | FKVP110EDED | 720,23 | FKVP110ESED | 1.171,01 | FKVP110EDEFD | 920,87 | FKVP110ESEFD | 1.382,24 |
| 125 (A1) | FKVP140EDED | 888,05 | FKVP140ESED | 1.565,45 | FKVP140EDEFD | 1.088,69 | FKVP140ESEFD | 1.776,65 |
| 140 | FKVP140EDED | 888,05 | FKVP140ESED | 1.565,45 | FKVP140EDEFD | 1.088,69 | FKVP140ESEFD | 1.776,65 |
| 160 | FKVP160EDED | 946,14 | FKVP160ESED | 1.623,52 | FKVP160EDEFD | 1.146,75 | FKVP160ESEFD | 1.834,72 |
| 200 (A2) | FKVP225EDED | 1.406,03 | FKVP225ESED | 2.335,71 | FKVP225EDEFD | 1.606,65 | FKVP225ESEFD | 2.546,96 |
| 225 | FKVP225EDED | 1.406,03 | FKVP225ESED | 2.335,71 | FKVP225EDEFD | 1.606,65 | FKVP225ESEFD | 2.546,96 |
| 250 (A3) | FKVP280EDED | 3.370,78 | FKVP280ESED | 5.341,77 | FKVP280EDEFD | 3.571,40 | FKVP280ESEFD | 5.552,99 |
| 280 | FKVP280EDED | 3.370,78 | FKVP280ESED | 5.341,77 | FKVP280EDEFD | 3.571,40 | FKVP280ESEFD | 5.552,99 |
| 315 | FKVP315EDED | 3.863,94 | FKVP315ESED | 6.585,05 | FKVP315EDEFD | 4.064,57 | FKVP315ESEFD | 6.796,25 |
| 355 | FKVP355EDED | 6.285,55 | FKVP355ESED | 8.336,13 | | | | |
| 400 | FKVP400EDED | 6.942,10 | FKVP400ESED | 10.843,84 | | | | |

| | | | | | | | | |
|----------|-------------|-----------|-------------|-----------|--------------|----------|--------------|----------|
| 50 | FKVP050FDED | 673,91 | FKVP050FSED | 764,24 | FKVP050FDEFD | 874,50 | FKVP050FSEFD | 975,46 |
| 63 | FKVP063FDED | 701,12 | FKVP063FSED | 791,45 | FKVP063FDEFD | 901,71 | FKVP063FSEFD | 1.002,68 |
| 75 | FKVP075FDED | 791,28 | FKVP075FSED | 924,79 | FKVP075FDEFD | 991,89 | FKVP075FSEFD | 1.135,99 |
| 90 | FKVP090FDED | 893,09 | FKVP090FSED | 1.012,83 | FKVP090FDEFD | 1.093,71 | FKVP090FSEFD | 1.224,03 |
| 110 | FKVP110FDED | 940,99 | FKVP110FSED | 1.391,74 | FKVP110FDEFD | 1.141,60 | FKVP110FSEFD | 1.602,97 |
| 125 (A1) | FKVP140FDED | 1.187,16 | FKVP140FSED | 1.864,54 | FKVP140FDEFD | 1.387,77 | FKVP140FSEFD | 2.075,76 |
| 140 | FKVP140FDED | 1.187,16 | FKVP140FSED | 1.864,54 | FKVP140FDEFD | 1.387,77 | FKVP140FSEFD | 2.075,76 |
| 160 | FKVP160FDED | 1.255,39 | FKVP160FSED | 1.932,77 | FKVP160FDEFD | 1.456,01 | FKVP160FSEFD | 2.144,00 |
| 200 (A2) | FKVP225FDED | 1.809,71 | FKVP225FSED | 2.739,39 | FKVP225FDEFD | 2.010,33 | FKVP225FSEFD | 2.950,62 |
| 225 | FKVP225FDED | 1.809,71 | FKVP225FSED | 2.739,39 | FKVP225FDEFD | 2.010,33 | FKVP225FSEFD | 2.950,62 |
| 250 (A3) | FKVP280FDED | 5.063,97 | FKVP280FSED | 7.034,93 | FKVP280FDEFD | 5.264,59 | FKVP280FSEFD | 7.246,15 |
| 280 | FKVP280FDED | 5.063,97 | FKVP280FSED | 7.034,93 | FKVP280FDEFD | 5.264,59 | FKVP280FSEFD | 7.246,15 |
| 315 | FKVP315FDED | 5.709,63 | FKVP315FSED | 8.430,74 | FKVP315FDEFD | 5.910,24 | FKVP315FSEFD | 8.641,94 |
| 355 | FKVP355FDED | 10.244,64 | FKVP355FSED | 12.295,24 | | | | |
| 400 | FKVP400FDED | 12.661,33 | FKVP400FSED | 16.563,05 | | | | |

Válvula de mariposa industrial motorizada.

Cuerpo en PPGR y disco en PVC-U.

Actuación neumática.

(A1) = a utilizar con portabridas QPV especial no incluido (transforma la válvula de mariposa de 140 en 125)

(A2) = a utilizar con portabridas QPV especial no incluido (transforma la válvula de mariposa de 225 en 200)

(A3) = a utilizar con tubo de diámetro 250 SDR 26 (PN10)

Las válvulas neumáticas se configuran NC (normalmente cerrada) de serie.
La configuración NA (normalmente abierta) se debe especificar en el pedido.



FKOV/CP

ACTUACIÓN NEUMÁTICA POLIAMIDA

ACTUACIÓN NEUMÁTICA POLIAMIDA CON ELECTROVÁLVULA, FINALES DE CARRERA (ELECTROMECÁNICOS) Y REGULADORES DE ESCAPE

| d | DOBLE EFECTO | | SIMPLE EFECTO | | DOBLE EFECTO | | SIMPLE EFECTO | |
|----------|--------------|-----------|---------------|-----------|--------------|----------|---------------|----------|
| | Ref. | € | Ref. | € | Ref. | € | Ref. | € |
| 50 | FKVP050EDEP | 614,24 | FKVP050ESEP | 777,44 | FKVP050EDEF | 876,72 | FKVP050ESEFP | 1.039,89 |
| 63 | FKVP063EDEP | 631,68 | FKVP063ESEP | 794,83 | FKVP063EDEF | 894,09 | FKVP063ESEFP | 1.057,27 |
| 75 | FKVP075EDEP | 666,51 | FKVP075ESEP | 829,67 | FKVP075EDEF | 928,96 | FKVP075ESEFP | 1.092,09 |
| 90 | FKVP090EDEP | 793,34 | FKVP090ESEP | 859,84 | FKVP090EDEF | 1.055,78 | FKVP090ESEFP | 1.122,32 |
| 110 | FKVP110EDEP | 825,22 | FKVP110ESEP | 1.086,94 | FKVP110EDEF | 1.087,63 | FKVP110ESEFP | 1.349,40 |
| 125 (A1) | FKVP140EDEP | 951,67 | FKVP140ESEP | 1.513,59 | FKVP140EDEF | 1.214,14 | FKVP140ESEFP | 1.776,03 |
| 140 | FKVP140EDEP | 951,67 | FKVP140ESEP | 1.513,59 | FKVP140EDEF | 1.214,14 | FKVP140ESEFP | 1.776,03 |
| 160 | FKVP160EDEP | 1.193,39 | FKVP160ESEP | 1.571,68 | FKVP160EDEF | 1.455,83 | FKVP160ESEFP | 1.834,10 |
| 200 (A2) | FKVP225EDEP | 1.387,41 | FKVP225ESEP | 2.168,10 | FKVP225EDEF | 1.649,85 | FKVP225ESEFP | 2.430,54 |
| 225 | FKVP225EDEP | 1.387,41 | FKVP225ESEP | 2.168,10 | FKVP225EDEF | 1.649,85 | FKVP225ESEFP | 2.430,54 |
| 250*(A3) | FKVP280EDEP | 3.549,48 | FKVP280ESEP | 5.222,98 | FKVP280EDEF | 3.811,93 | FKVP280ESEFP | 5.485,42 |
| 280* | FKVP280EDEP | 3.549,48 | FKVP280ESEP | 5.222,98 | FKVP280EDEF | 3.811,93 | FKVP280ESEFP | 5.485,42 |
| 315* | FKVP315EDEP | 3.774,57 | FKVP315ESEP | 5.448,08 | FKVP315EDEF | 4.036,98 | FKVP315ESEFP | 5.710,53 |
| 355 | FKVP355EDEP | Consultar | FKVP355ESEP | Consultar | | | | |
| 400 | FKVP400EDEP | Consultar | FKVP400ESEP | Consultar | | | | |

| | | | | | | | | |
|----------|-------------|-----------|-------------|-----------|-------------|----------|--------------|----------|
| 50 | FKVP050FDEP | 780,87 | FKVP050FSEP | 944,03 | FKVP050FDEF | 1.043,29 | FKVP050FSEFP | 1.206,47 |
| 63 | FKVP063FDEP | 808,07 | FKVP063FSEP | 971,22 | FKVP063FDEF | 1.070,51 | FKVP063FSEFP | 1.233,66 |
| 75 | FKVP075FDEP | 862,47 | FKVP075FSEP | 1.025,62 | FKVP075FDEF | 1.124,95 | FKVP075FSEFP | 1.288,10 |
| 90 | FKVP090FDEP | 998,05 | FKVP090FSEP | 1.064,54 | FKVP090FDEF | 1.260,46 | FKVP090FSEFP | 1.326,98 |
| 110 | FKVP110FDEP | 1.045,91 | FKVP110FSEP | 1.307,67 | FKVP110FDEF | 1.308,36 | FKVP110FSEFP | 1.570,11 |
| 125 (A1) | FKVP140FDEP | 1.250,78 | FKVP140FSEP | 1.812,70 | FKVP140FDEF | 1.513,22 | FKVP140FSEFP | 2.075,12 |
| 140 | FKVP140FDEP | 1.250,78 | FKVP140FSEP | 1.812,70 | FKVP140FDEF | 1.513,22 | FKVP140FSEFP | 2.075,12 |
| 160 | FKVP160FDEP | 1.502,65 | FKVP160FSEP | 1.880,91 | FKVP160FDEF | 1.765,09 | FKVP160FSEFP | 2.143,36 |
| 200 (A2) | FKVP225FDEP | 1.791,07 | FKVP225FSEP | 2.571,79 | FKVP225FDEF | 2.053,51 | FKVP225FSEFP | 2.834,23 |
| 225 | FKVP225FDEP | 1.791,07 | FKVP225FSEP | 2.571,79 | FKVP225FDEF | 2.053,51 | FKVP225FSEFP | 2.834,23 |
| 250*(A3) | FKVP280FDEP | 5.242,65 | FKVP280FSEP | 6.916,17 | FKVP280FDEF | 5.505,09 | FKVP280FSEFP | 7.178,62 |
| 280* | FKVP280FDEP | 5.242,65 | FKVP280FSEP | 6.916,17 | FKVP280FDEF | 5.505,09 | FKVP280FSEFP | 7.178,62 |
| 315* | FKVP315FDEP | 5.620,25 | FKVP315FSEP | 7.293,77 | FKVP315FDEF | 5.882,67 | FKVP315FSEFP | 7.556,18 |
| 355 | FKVP355FDEP | Consultar | FKVP355FSEP | Consultar | | | | |
| 400 | FKVP400FDEP | Consultar | FKVP400FSEP | Consultar | | | | |

Válvula de mariposa industrial motorizada.

Cuerpo en PPGR y disco en PVC-U.

Actuación neumática.

(A1) = a utilizar con portabridas QPV especial no incluido (transforma la válvula de mariposa de 140 en 125)

(A2) = a utilizar con portabridas QPV especial no incluido (transforma la válvula de mariposa de 225 en 200)

(A3) = a utilizar con tubo de diámetro 250 SDR 26 (PN10) * Actuadores de aluminio

Las válvulas neumáticas se configuran NC (normalmente cerrada) de serie.

La configuración NA (normalmente abierta) se debe especificar en el pedido.



INDUSTRIA

Válvulas motorizadas de PVC-U presión

Válvulas de membrana actuadas

**DK/CP NC****VM/CP NC**

| d | Modelo | DN | € | | € | | € | |
|-----|------------|-----|------------|----------|------------|----------|------------|----------|
| | | | Ref. EPDM | EPDM | Ref. FKM | FKM | Ref. PTFE | PTFE |
| 20 | DKDV/CP NC | 15 | DKDVNC020E | 344,95 | DKDVNC020F | 403,97 | DKDVNC020P | 428,46 |
| 25 | DKDV/CP NC | 20 | DKDVNC025E | 362,18 | DKDVNC025F | 423,59 | DKDVNC025P | 449,34 |
| 32 | DKDV/CP NC | 25 | DKDVNC032E | 443,47 | DKDVNC032F | 517,11 | DKDVNC032P | 546,00 |
| 40 | DKDV/CP NC | 32 | DKDVNC040E | 590,79 | DKDVNC040F | 712,09 | DKDVNC040P | 743,92 |
| 50 | DKDV/CP NC | 40 | DKDVNC050E | 670,38 | DKDVNC050F | 801,58 | DKDVNC050P | 837,52 |
| 63 | DKDV/CP NC | 50 | DKDVNC063E | 939,08 | DKDVNC063F | 1.162,51 | DKDVNC063P | 1.156,28 |
| 75 | VMDV/CP NC | 65 | VMDVNC075E | 1.126,87 | VMDVNC075F | 1.395,51 | VMDVNC075P | 1.387,56 |
| 90 | VMDV/CP NC | 80 | VMDVNC090E | 1.723,07 | VMDVNC090F | 2.296,57 | VMDVNC090P | 1.991,79 |
| 110 | VMDV/CP NC | 100 | VMDVNC110E | 2.130,25 | VMDVNC110F | 2.677,12 | VMDVNC110P | 2.384,24 |

Válvula neumática **NORMALMENTE CERRADA.**

M-M encolar

DK/CP NO**VM/CP NO**

| d | Modelo | DN | € | | € | | € | |
|-----|------------|-----|------------|----------|------------|----------|------------|----------|
| | | | Ref. EPDM | EPDM | Ref. FKM | FKM | Ref. PTFE | PTFE |
| 20 | DKDV/CP NO | 15 | DKDVNO020E | 283,02 | DKDVNO020F | 342,01 | DKDVNO020P | 366,56 |
| 25 | DKDV/CP NO | 20 | DKDVNO025E | 300,22 | DKDVNO025F | 361,63 | DKDVNO025P | 387,38 |
| 32 | DKDV/CP NO | 25 | DKDVNO032E | 373,99 | DKDVNO032F | 482,95 | DKDVNO032P | 516,24 |
| 40 | DKDV/CP NO | 32 | DKDVNO040E | 389,34 | DKDVNO040F | 545,80 | DKDVNO040P | 586,74 |
| 50 | DKDV/CP NO | 40 | DKDVNO050E | 444,10 | DKDVNO050F | 624,67 | DKDVNO050P | 670,99 |
| 63 | DKDV/CP NO | 50 | DKDVNO063E | 590,43 | DKDVNO063F | 872,51 | DKDVNO063P | 864,43 |
| 75 | DKDV/CP NO | 65 | DKDVNO075E | 708,49 | DKDVNO075F | 1.047,00 | DKDVNO075P | 1.037,29 |
| 90 | VMDV/CP NO | 80 | VMDVNO090E | 1.149,72 | VMDVNO090F | 1.827,04 | VMDVNO090P | 1.466,39 |
| 110 | VMDV/CP NO | 100 | VMDVNO110E | 1.750,18 | VMDVNO110F | 2.480,22 | VMDVNO110P | 2.060,36 |

Válvula neumática **NORMALMENTE ABIERTA.**

M-M encolar

DK/CP DE**VM/CP DE**

| d | Modelo | DN | € | | € | | € | |
|-----|------------|-----|------------|----------|------------|----------|------------|----------|
| | | | Ref. EPDM | EPDM | Ref. FKM | FKM | Ref. PTFE | PTFE |
| 20 | DKDV/CP DE | 15 | DKDVDA020E | 221,12 | DKDVDA020F | 280,11 | DKDVDA020P | 304,62 |
| 25 | DKDV/CP DE | 20 | DKDVDA025E | 238,32 | DKDVDA025F | 299,76 | DKDVDA025P | 325,51 |
| 32 | DKDV/CP DE | 25 | DKDVDA032E | 325,30 | DKDVDA032F | 427,17 | DKDVDA032P | 458,64 |
| 40 | DKDV/CP DE | 32 | DKDVDA040E | 353,91 | DKDVDA040F | 496,15 | DKDVDA040P | 533,39 |
| 50 | DKDV/CP DE | 40 | DKDVDA050E | 293,83 | DKDVDA050F | 401,26 | DKDVDA050P | 431,04 |
| 63 | DKDV/CP DE | 50 | DKDVDA063E | 379,26 | DKDVDA063F | 560,45 | DKDVDA063P | 555,26 |
| 75 | DKDV/CP DE | 65 | DKDVDA075E | 455,09 | DKDVDA075F | 672,56 | DKDVDA075P | 666,31 |
| 90 | VMDV/CP DE | 80 | VMDVDA090E | 1.434,84 | VMDVDA090F | 2.112,17 | VMDVDA090P | 1.751,49 |
| 110 | VMDV/CP DE | 100 | VMDVDA110E | 2.023,88 | VMDVDA110F | 2.554,38 | VMDVDA110P | 2.334,03 |

Válvula neumática **DOBLE EFECTO.**

M-M encolar

**DK/CP NC**

| d | Modelo | DN | Ref. EPDM | € EPDM | Ref. FKM | € FKM | Ref. PTFE | € PTFE |
|----|-------------|----|-------------|-----------|-------------|----------|-------------|-----------|
| 20 | DKUIV/CP NC | 15 | DKUIVNC020E | 346,27 | DKUIVNC020F | 421,09 | DKUIVNC020P | 451,81 |
| 25 | DKUIV/CP NC | 20 | DKUIVNC025E | 365,86 | DKUIVNC025F | 434,64 | DKUIVNC025P | 476,41 |
| 32 | DKUIV/CP NC | 25 | DKUIVNC032E | 452,12 | DKUIVNC032F | 548,92 | DKUIVNC032P | 584,99 |
| 40 | DKUIV/CP NC | 32 | DKUIVNC040E | 600,90 | DKUIVNC040F | 753,96 | DKUIVNC040P | 791,56 |
| 50 | DKUIV/CP NC | 40 | DKUIVNC050E | 695,35 | DKUIVNC050F | 867,21 | DKUIVNC050P | 910,93 |
| 63 | DKUIV/CP NC | 50 | DKUIVNC063E | 965,71 | DKUIVNC063F | 1.239,09 | DKUIVNC063P | 1.231,67 |

 Válvula neumática **NORMALMENTE CERRADA.**

Con enlaces H-H para encolar.

**DK/CP NO**

| d | Modelo | DN | Ref. EPDM | € EPDM | Ref. FKM | € FKM | Ref. PTFE | € PTFE |
|----|-------------|----|-------------|-----------|-------------|----------|-------------|-----------|
| 20 | DKUIV/CP NO | 15 | DKUIVNO020E | 284,33 | DKUIVNO020F | 359,16 | DKUIVNO020P | 389,91 |
| 25 | DKUIV/CP NO | 20 | DKUIVNO025E | 303,95 | DKUIVNO025F | 372,71 | DKUIVNO025P | 414,47 |
| 32 | DKUIV/CP NO | 25 | DKUIVNO032E | 398,15 | DKUIVNO032F | 517,30 | DKUIVNO032P | 471,23 |
| 40 | DKUIV/CP NO | 32 | DKUIVNO040E | 433,99 | DKUIVNO040F | 603,51 | DKUIVNO040P | 651,94 |
| 50 | DKUIV/CP NO | 40 | DKUIVNO050E | 525,97 | DKUIVNO050F | 719,40 | DKUIVNO050P | 773,79 |
| 63 | DKUIV/CP NO | 50 | DKUIVNO063E | 678,87 | DKUIVNO063F | 989,37 | DKUIVNO063P | 979,30 |

 Válvula neumática **NORMALMENTE ABIERTA.**

Con enlaces H-H para encolar.

**DK/CP DE**

| d | Modelo | DN | Ref. EPDM | € EPDM | Ref. FKM | € FKM | Ref. PTFE | € PTFE |
|----|-------------|----|-------------|-----------|-------------|----------|-------------|-----------|
| 20 | DKUIV/CP DE | 15 | DKUIVDA020E | 222,43 | DKUIVDA020F | 297,24 | DKUIVDA020P | 327,98 |
| 25 | DKUIV/CP DE | 20 | DKUIVDA025E | 242,03 | DKUIVDA025F | 310,78 | DKUIVDA025P | 352,52 |
| 32 | DKUIV/CP DE | 25 | DKUIVDA032E | 347,50 | DKUIVDA032F | 458,87 | DKUIVDA032P | 501,80 |
| 40 | DKUIV/CP DE | 32 | DKUIVDA040E | 394,54 | DKUIVDA040F | 548,61 | DKUIVDA040P | 592,66 |
| 50 | DKUIV/CP DE | 40 | DKUIVDA050E | 464,21 | DKUIVDA050F | 634,94 | DKUIVDA050P | 838,98 |
| 63 | DKUIV/CP DE | 50 | DKUIVDA063E | 599,14 | DKUIVDA063F | 873,24 | DKUIVDA063P | 864,34 |

 Válvula neumática **DOBLE EFECTO.**

Con enlaces H-H para encolar.

**DK/CP NC**

| Rh | Modelo | DN | Ref. EPDM | € EPDM | Ref. FKM | € FKM | Ref. PTFE | € PTFE |
|-----|-------------|----|-------------|-----------|-------------|----------|-------------|-----------|
| ½" | DKUFV/CP NC | 15 | DKUFVNC012E | 346,27 | DKUFVNC012F | 421,09 | DKUFVNC012P | 451,81 |
| ¾" | DKUFV/CP NC | 20 | DKUFVNC034E | 365,86 | DKUFVNC034F | 434,64 | DKUFVNC034P | 476,41 |
| 1" | DKUFV/CP NC | 25 | DKUFVNC100E | 452,12 | DKUFVNC100F | 548,92 | DKUFVNC100P | 584,99 |
| 1¼" | DKUFV/CP NC | 32 | DKUFVNC114E | 600,90 | DKUFVNC114F | 753,96 | DKUFVNC114P | 791,56 |
| 1½" | DKUFV/CP NC | 40 | DKUFVNC112E | 695,35 | DKUFVNC112F | 867,21 | DKUFVNC112P | 884,39 |
| 2" | DKUFV/CP NC | 50 | DKUFVNC200E | 945,88 | DKUFVNC200F | 1.239,09 | DKUFVNC200P | 1.195,80 |

Válvula neumática **NORMALMENTE CERRADA.**

Con enlaces H-H para roscar.

**DK/CP NO**

| Rh | Modelo | DN | Ref. EPDM | € EPDM | Ref. FKM | € FKM | Ref. PTFE | € PTFE |
|-----|-------------|----|-------------|-----------|-------------|----------|-------------|-----------|
| ½" | DKUFV/CP NO | 15 | DKUFVNO012E | 284,33 | DKUFVNO012F | 359,16 | DKUFVNO012P | 389,91 |
| ¾" | DKUFV/CP NO | 20 | DKUFVNO034E | 303,95 | DKUFVNO034F | 372,71 | DKUFVNO034P | 414,47 |
| 1" | DKUFV/CP NO | 25 | DKUFVNO100E | 398,15 | DKUFVNO100F | 517,30 | DKUFVNO100P | 471,23 |
| 1¼" | DKUFV/CP NO | 32 | DKUFVNO114E | 433,99 | DKUFVNO114F | 603,51 | DKUFVNO114P | 651,94 |
| 1½" | DKUFV/CP NO | 40 | DKUFVNO112E | 525,97 | DKUFVNO112F | 719,40 | DKUFVNO112P | 773,79 |
| 2" | DKUFV/CP NO | 50 | DKUFVNO200E | 678,87 | DKUFVNO200F | 989,37 | DKUFVNO200P | 979,30 |

Válvula neumática **NORMALMENTE ABIERTA.**

Con enlaces H-H para roscar.

**DK/CP DE**

| Rh | Modelo | DN | Ref. EPDM | € EPDM | Ref. FKM | € FKM | Ref. PTFE | € PTFE |
|-----|-------------|----|-------------|-----------|-------------|----------|-------------|-----------|
| ½" | DKUFV/CP DE | 15 | DKUFVDA012E | 222,43 | DKUFVDA012F | 297,24 | DKUFVDA012P | 327,98 |
| ¾" | DKUFV/CP DE | 20 | DKUFVDA034E | 242,03 | DKUFVDA034F | 310,78 | DKUFVDA034P | 352,52 |
| 1" | DKUFV/CP DE | 25 | DKUFVDA100E | 347,50 | DKUFVDA100F | 458,87 | DKUFVDA100P | 501,80 |
| 1¼" | DKUFV/CP DE | 32 | DKUFVDA114E | 394,54 | DKUFVDA114F | 548,61 | DKUFVDA114P | 592,66 |
| 1½" | DKUFV/CP DE | 40 | DKUFVDA112E | 464,21 | DKUFVDA112F | 634,94 | DKUFVDA112P | 682,96 |
| 2" | DKUFV/CP DE | 50 | DKUFVDA200E | 599,14 | DKUFVDA200F | 873,24 | DKUFVDA200P | 864,34 |

Válvula neumática **DOBLE EFECTO.**

Con enlaces H-H para roscar.



DK/CP NC

| d | Modelo | DN | Ref. EPDM | € EPDM |
|-----|------------|-----|------------|-----------|
| 20 | DKOV/CP NC | 15 | DKOVNC020E | 396,70 |
| 25 | DKOV/CP NC | 20 | DKOVNC025E | 416,48 |
| 32 | DKOV/CP NC | 25 | DKOVNC032E | 510,00 |
| 40 | DKOV/CP NC | 32 | DKOVNC040E | 679,42 |
| 50 | DKOV/CP NC | 40 | DKOVNC050E | 770,96 |
| 63 | DKOV/CP NC | 50 | DKOVNC063E | 1.079,96 |
| 75 | DKOV/CP NC | 65 | DKOVNC075E | 1.295,95 |
| 90 | VMOV/CP NC | 80 | VMOVNC090E | 1.981,60 |
| 110 | VMOV/CP NC | 100 | VMOVNC110E | 2.449,80 |



VM/CP NC

| Ref. FKM | € FKM | Ref. PTFE | € PTFE |
|------------|----------|------------|-----------|
| DKOVNC020F | 455,67 | DKOVNC020P | 480,22 |
| DKOVNC025F | 477,90 | DKOVNC025P | 503,65 |
| DKOVNC032F | 583,63 | DKOVNC032P | 612,49 |
| DKOVNC040F | 800,67 | DKOVNC040P | 832,53 |
| DKOVNC050F | 902,18 | DKOVNC050P | 938,10 |
| DKOVNC063F | 1.303,41 | DKOVNC063P | 1.297,16 |
| DKOVNC075F | 1.564,09 | DKOVNC075P | 1.556,59 |
| VMOVNC090F | 2.555,00 | VMOVNC090P | 2.250,27 |
| VMOVNC110F | 2.995,70 | VMOVNC110P | 2.703,52 |

Válvula neumática **NORMALMENTE CERRADA.**
 Con bridas DIN.

Disponibles con bridas ANSI 150 libras al mismo precio



DK/CP NO

| d | Modelo | DN | Ref. EPDM | € EPDM |
|-----|------------|-----|------------|-----------|
| 20 | DKOV/CP NO | 15 | DKOVNO020E | 334,75 |
| 25 | DKOV/CP NO | 20 | DKOVNO025E | 354,58 |
| 32 | DKOV/CP NO | 25 | DKOVNO032E | 449,88 |
| 40 | DKOV/CP NO | 32 | DKOVNO040E | 486,81 |
| 50 | DKOV/CP NO | 40 | DKOVNO050E | 568,05 |
| 63 | DKOV/CP NO | 50 | DKOVNO063E | 745,39 |
| 75 | DKOV/CP NO | 65 | DKOVNO075E | 894,45 |
| 90 | VMOV/CP NO | 80 | VMOVNO090E | 1.408,20 |
| 110 | VMOV/CP NO | 100 | VMOVNO110E | 1.992,10 |



VM/CP NO

| Ref. FKM | € FKM | Ref. PTFE | € PTFE |
|------------|----------|------------|-----------|
| DKOVNO020F | 393,72 | DKOVNO020P | 418,31 |
| DKOVNO025F | 415,97 | DKOVNO025P | 441,75 |
| DKOVNO032F | 558,78 | DKOVNO032P | 486,68 |
| DKOVNO040F | 643,21 | DKOVNO040P | 684,16 |
| DKOVNO050F | 735,35 | DKOVNO050P | 781,65 |
| DKOVNO063F | 1.027,48 | DKOVNO063P | 1.019,39 |
| DKOVNO075F | 1.232,96 | DKOVNO075P | 1.223,28 |
| VMOVNO090F | 2.085,52 | VMOVNO090P | 1.724,82 |
| VMOVNO110F | 2.707,08 | VMOVNO110P | 2.302,36 |

Válvula neumática **NORMALMENTE ABIERTA.**
 Con bridas DIN.

Disponibles con bridas ANSI 150 libras al mismo precio



DK/CP DE

| d | Modelo | DN | Ref. EPDM | € EPDM |
|-----|------------|-----|------------|-----------|
| 20 | DKOV/CP DE | 15 | DKOVDA020E | 272,85 |
| 25 | DKOV/CP DE | 20 | DKOVDA025E | 292,65 |
| 32 | DKOV/CP DE | 25 | DKOVDA032E | 396,81 |
| 40 | DKOV/CP DE | 32 | DKOVDA040E | 442,54 |
| 50 | DKOV/CP DE | 40 | DKOVDA050E | 501,38 |
| 63 | DKOV/CP DE | 50 | DKOVDA063E | 657,89 |
| 75 | DKOV/CP DE | 65 | DKOVDA075E | 789,44 |
| 90 | VMOV/CP DE | 80 | VMOVDA090E | 1.693,32 |
| 110 | VMOV/CP DE | 100 | VMOVDA110E | 2.265,82 |



VM/CP DE

| Ref. FKM | € FKM | Ref. PTFE | € PTFE |
|------------|----------|------------|-----------|
| DKOVDA020F | 331,81 | DKOVDA020P | 356,38 |
| DKOVDA025F | 354,06 | DKOVDA025P | 379,81 |
| DKOVDA032F | 498,62 | DKOVDA032P | 530,09 |
| DKOVDA040F | 584,76 | DKOVDA040P | 621,97 |
| DKOVDA050F | 649,03 | DKOVDA050P | 649,03 |
| DKOVDA063F | 906,86 | DKOVDA063P | 906,86 |
| DKOVDA075F | 1.088,24 | DKOVDA075P | 1.088,24 |
| VMOVDA090F | 2.370,65 | VMOVDA090P | 2.009,89 |
| VMOVDA110F | 2.766,07 | VMOVDA110P | 2.576,01 |

Válvula neumática **DOBLE EFECTO.**
 Con bridas DIN.

Disponibles con bridas ANSI 150 libras al mismo precio

CMDV/CP NC M-M encolar.
CMIV/CP NC H-H encolar.
CMUIV/CP NC H-H enlaces encolar.
CMFV/CP NC H-H roscar.



| d-Rh | Ref. EPDM | DN | € EPDM | € FKM | € PTFE |
|---------|--------------------|----|---------------|---------------|---------------|
| 20 | CMDVNC020E | 15 | 166,07 | 189,21 | 209,43 |
| 16 | CMIVNC016E | 12 | 155,99 | 184,92 | 197,86 |
| 20 | CMIVNC020E | 15 | 155,99 | 184,92 | 197,86 |
| 20-1/2" | CMUIVNC020E | 15 | 213,81 | 235,46 | 254,20 |
| 3/8" | CMFVNC038E | 12 | 155,99 | 184,92 | 197,86 |
| 1/2" | CMFVNC012E | 15 | 155,99 | 184,92 | 197,86 |

Válvula de membrana compacta neumática
NORMALMENTE CERRADA

Código en FKM termina en "F" en lugar de "E"
 Código en PTFE termina en "P" en lugar de "E"
 (A) = Juntas en FKM

CMDV/CP NO M-M encolar.
CMIV/CP NO H-H encolar.
CMUIV/CP NO H-H enlaces encolar.
CMFV/CP NO H-H roscar.



| d-Rh | Ref. EPDM | DN | € EPDM | € FKM | € PTFE |
|---------|--------------------|----|---------------|---------------|---------------|
| 20 | CMDVNO020E | 15 | 163,20 | 186,33 | 205,12 |
| 16 | CMIVNO016E | 12 | 154,58 | 179,12 | 194,96 |
| 20 | CMIVNO020E | 15 | 154,58 | 179,12 | 194,96 |
| 20-1/2" | CMUIVNO020E | 15 | 212,37 | 231,11 | 251,32 |
| 3/8" | CMFVNO038E | 12 | 154,58 | 179,12 | 194,96 |
| 1/2" | CMFVNO012E | 15 | 154,58 | 179,12 | 194,96 |

Válvula de membrana compacta neumática
NORMALMENTE ABIERTA

Código en FKM termina en "F" en lugar de "E"
 Código en PTFE termina en "P" en lugar de "E"
 (A) = Juntas en FKM

CMDV/CP DE M-M encolar.
CMIV/CP DE H-H encolar.
CMUIV/CP DE H-H enlaces encolar.
CMFV/CP DE H-H roscar.



| d-Rh | Ref. EPDM | DN | € EPDM | € FKM | € PTFE |
|---------|--------------------|----|---------------|---------------|---------------|
| 20 | CMDVDA020E | 15 | 163,20 | 186,33 | 205,12 |
| 16 | CMIVDA016E | 12 | 154,58 | 179,12 | 194,96 |
| 20 | CMIVDA020E | 15 | 154,58 | 179,12 | 194,96 |
| 20-1/2" | CMUIVDA020E | 15 | 212,37 | 231,11 | 251,32 |
| 3/8" | CMFVDA038E | 12 | 154,58 | 179,12 | 194,96 |
| 1/2" | CMFVDA012E | 15 | 154,58 | 179,12 | 194,96 |

Válvula de membrana compacta neumática
DOBLE EFECTO

Código en FKM termina en "F" en lugar de "E"
 Código en PTFE termina en "P" en lugar de "E"
 (A) = Juntas en FKM

DKDDV/CP NO



| d | Ref. EPDM | DN | PN | € EPDM |
|----|--------------------|----|----|---------------|
| 20 | DKDDVNO020E | 15 | 8 | 95,28 |
| 25 | DKDDVNO025E | 20 | 8 | 111,24 |
| 32 | DKDDVNO032E | 25 | 8 | 122,78 |
| 40 | DKDDVNO040E | 32 | 8 | 141,55 |
| 50 | DKDDVNO050E | 40 | 8 | 173,30 |
| 63 | DKDDVNO063E | 50 | 8 | 186,33 |
| 75 | DKDDVNO075E | 65 | 8 | 223,59 |

Válvula de membrana normalmente abierta acción directa.

Disponible embrizada
 Precios: Consultar

Membrana en EPDM. M-M encolar.

DKDUIV/CP NO



| d | Ref. EPDM | DN | PN | € EPDM |
|----|---------------------|----|----|---------------|
| 20 | DKDUIVNO020E | 15 | 8 | 112,66 |
| 25 | DKDUIVNO025E | 20 | 8 | 129,97 |
| 32 | DKDUIVNO032E | 25 | 8 | 147,34 |
| 40 | DKDUIVNO040E | 32 | 8 | 176,26 |
| 50 | DKDUIVNO050E | 40 | 8 | 235,59 |
| 63 | DKDUIVNO063E | 50 | 8 | 242,62 |

Válvula de membrana normalmente abierta acción directa.
 Membrana en EPDM. H-H enlaces encolar.

DKDUFV/CP NO



| Rh | Ref. EPDM | DN | PN | € EPDM |
|--------|---------------------|----|----|---------------|
| 1/2" | DKDUFVNO012E | 15 | 8 | 122,78 |
| 3/4" | DKDUFVNO034E | 20 | 8 | 140,13 |
| 1" | DKDUFVNO100E | 25 | 8 | 160,32 |
| 1 1/4" | DKDUFVNO114E | 32 | 8 | 206,55 |
| 1 1/2" | DKDUFVNO112E | 40 | 8 | 254,20 |
| 2" | DKDUFVNO200E | 50 | 8 | 278,77 |

Válvula de membrana normalmente abierta acción directa.
 Membrana en EPDM. H-H enlaces roscar.

DKBDV/CP NC

| d | Ref. EPDM | DN | PN | € EPDM |
|----|-------------|----|----|-----------|
| 20 | DKBDVNC020E | 15 | 6 | 311,58 |
| 25 | DKBDVNC025E | 20 | 6 | 327,15 |
| 32 | DKBDVNC032E | 25 | 6 | 419,16 |
| 40 | DKBDVNC040E | 32 | 6 | 527,41 |
| 50 | DKBDVNC050E | 40 | 6 | 553,24 |
| 63 | DKBDVNC063E | 50 | 6 | 774,97 |
| 75 | DKBDVNC075E | 65 | 6 | 929,97 |

Válvula de membrana neumática
Normalmente Cerrada.
M-M encolar.

Actuador a pistón

DKBUIV/CP NC

| d | Ref. EPDM | DN | PN | € EPDM |
|----|--------------|----|----|-----------|
| 20 | DKBUIVNC020E | 15 | 6 | 312,76 |
| 25 | DKBUIVNC025E | 20 | 6 | 271,27 |
| 32 | DKBUIVNC032E | 25 | 6 | 427,35 |
| 40 | DKBUIVNC040E | 32 | 6 | 536,48 |
| 50 | DKBUIVNC050E | 40 | 6 | 573,79 |
| 63 | DKBUIVNC063E | 50 | 6 | 796,89 |

Válvula de membrana neumática
Normalmente Cerrada.
Con enlaces H-H encolar.

Actuador a pistón

DKBUFV/CP NC

| Rh | Ref. EPDM | DN | PN | € EPDM |
|------|--------------|----|----|-----------|
| ½" | DKBUFVNC012E | 15 | 6 | 312,76 |
| ¾" | DKBUFVNC034E | 20 | 6 | 330,46 |
| 1" | DKBUFVNC100E | 25 | 6 | 427,35 |
| 1 ¼" | DKBUFVNC114E | 32 | 6 | 536,48 |
| 1 ½" | DKBUFVNC112E | 40 | 6 | 573,79 |
| 2" | DKBUFVNC200E | 50 | 6 | 796,89 |

Válvula de membrana neumática
Normalmente Cerrada.
Con enlaces H-H para roscar.

Actuador a pistón

DKBOV/CP NC

| d | Ref. EPDM | DN | PN | € EPDM |
|----|-------------|----|----|-----------|
| 20 | DKBOVNC020E | 15 | 6 | 358,34 |
| 25 | DKBOVNC025E | 20 | 6 | 376,19 |
| 32 | DKBOVNC032E | 25 | 6 | 491,13 |
| 40 | DKBOVNC040E | 32 | 6 | 623,25 |
| 50 | DKBOVNC050E | 40 | 6 | 653,77 |
| 63 | DKBOVNC063E | 50 | 6 | 915,88 |
| 75 | DKBOVNC075E | 65 | 6 | 1.190,63 |

Válvula de membrana neumática
Normalmente Cerrada.
Con bridas DIN.

Actuador a pistón

DKBOAV/CP NC

| d | Ref. EPDM | DN | PN | € EPDM |
|------|--------------|----|----|-----------|
| ½" | DKBOAVNC012E | 15 | 6 | 358,34 |
| ¾" | DKBOAVNC034E | 20 | 6 | 376,19 |
| 1" | DKBOAVNC100E | 25 | 6 | 476,80 |
| 1 ¼" | DKBOAVNC114E | 32 | 6 | 605,10 |
| 1 ½" | DKBOAVNC112E | 40 | 6 | 634,73 |
| 2" | DKBOAVNC200E | 50 | 6 | 889,20 |
| 2 ½" | DKBOAVNC212E | 65 | 6 | 1.155,95 |

Válvula de membrana neumática
Normalmente Cerrada.
Con bridas ANSI 150 lbs.

Actuador a pistón



Válvulas motorizadas de PVC-U presión

Válvulas de control de presión



SVUIV

| d - Rh | Ref. | DN | PN | € EPDM | € FKM |
|-----------|-----------|----|----|-----------|----------|
| 20 - 1/2" | SVUIV020E | 15 | 16 | 190,84 | 195,89 |
| 25 - 3/4" | SVUIV025E | 20 | 16 | 204,49 | 211,34 |
| 32 - 1" | SVUIV032E | 25 | 16 | 219,75 | 226,60 |

Válvula de sobrepresión seguridad.
Con enlaces H-H para encolar (rosacar bajo pedido).

Código en FKM termina en "F" en lugar de "E"
Rango de calibración: 0,3 - 4 bars



VPR

| d | Ref. | DN | PN | € EPDM | € FKM |
|----|-----------|----|----|-----------|----------|
| 16 | VPRDV016E | 10 | 10 | 969,16 | 1.003,53 |
| 20 | VPRDV020E | 15 | 10 | 969,16 | 1.003,53 |
| 25 | VPRDV025E | 20 | 10 | 1.233,68 | 1.288,46 |
| 32 | VPRDV032E | 25 | 10 | 1.233,68 | 1.288,46 |
| 40 | VPRDV040E | 32 | 10 | 1.484,98 | 1.551,18 |
| 50 | VPRDV050E | 40 | 10 | 1.484,98 | 1.551,18 |
| 63 | VPRDV063E | 50 | 10 | 2.101,54 | 2.166,86 |

Válvula reductora de presión.
M-M encolar.

Código en FKM termina en "F" en lugar de "E"
Rango de calibración: 0,5 - 9 bars



VSF

| d | Ref. | EPDM | DN | PN | € EPDM | € PTFE |
|-----|-----------|------|----|----------|-----------|-----------|
| 16 | VSFDV016E | 10 | 10 | 379,14 | 435,02 | |
| 20 | VSFDV020E | 15 | 10 | 441,44 | 468,32 | |
| 25 | VSFDV025E | 20 | 10 | 493,63 | 535,60 | |
| 32 | VSFDV032E | 25 | 10 | 521,95 | 562,02 | |
| 40 | VSFDV040E | 32 | 10 | 655,42 | 718,12 | |
| 50 | VSFDV050E | 40 | 10 | 1.253,92 | 1.304,65 | |
| 63 | VSFDV063E | 50 | 10 | 1.473,34 | 1.520,23 | |
| 75 | VSFDV075E | 65 | 10 | 1.978,63 | 2.073,88 | |
| 90 | VSFDV090E | 80 | 10 | 3.315,55 | 3.471,62 | |
| 110 | VSFDV110E | 100 | 10 | 4.766,15 | 4.957,03 | |

Válvula de sobrepresión-alivio.
M-M encolar.

Código en PTFE termina en "P" en lugar de "E"
Rango de calibración: 0,5 - 10 bars



VCP

| d | Ref. | EPDM | DN | PN | € EPDM | € PTFE |
|----|-----------|------|----|----------|-----------|-----------|
| 16 | VCPDV016E | 10 | 10 | 344,33 | 368,51 | |
| 20 | VCPDV020E | 15 | 10 | 348,14 | 383,62 | |
| 25 | VCPDV025E | 20 | 10 | 464,12 | 504,22 | |
| 32 | VCPDV032E | 25 | 10 | 495,51 | 548,78 | |
| 40 | VCPDV040E | 32 | 10 | 633,09 | 679,99 | |
| 50 | VCPDV050E | 40 | 10 | 1.197,46 | 1.241,44 | |
| 63 | VCPDV063E | 50 | 10 | 1.281,73 | 1.308,13 | |

Válvula retenedora de presión.
M-M encolar.

Código en PTFE termina en "P" en lugar de "E"
Rango de calibración: 0,5 - 10 bars

Flujómetros / rotámetros
Medidores electrónicos de caudal
Electrodos de pH y ORP
Sensores y transmisores de conductividad
Accesorios y recambios



0803

Medición

INDUSTRIA



Más información







FCIV
 encolar.

FLOTADOR INOX AISI 316

| Diámetro Encolar | Ref. Encolar | Escala l/h. | € |
|------------------|--------------|-------------|--------|
| 16 | FC16D1X0030 | 3-30 | 151,05 |
| 16 | FC16D1X0040 | 4-40 | 151,05 |
| 16 | FC16D1X0100 | 10-100 | 151,05 |
| 16 | FC16D1X0200 | 20-200 | 151,05 |
| 16 | FC16D1X0300 | 30-300 | 151,05 |
| 20 | FC20D1X0050 | 5-50 | 158,74 |
| 20 | FC20D1X0100 | 10-100 | 158,74 |
| 20 | FC20D1X0160 | 15-160 | 158,74 |
| 20 | FC20D1X0250 | 20-250 | 158,74 |
| 20 | FC20D1X0350 | 35-350 | 158,74 |
| 20 | FC20D1X0600 | 60-600 | 158,74 |
| 25 | FC25D1X0150 | 15-150 | 166,41 |
| 25 | FC25D1X0250 | 25-250 | 166,41 |
| 25 | FC25D1X0400 | 40-400 | 166,41 |
| 25 | FC25D1X0600 | 50-600 | 166,41 |
| 25 | FC25D1X1100 | 100-1100 | 166,41 |
| 32 | FC32D1X0400 | 40-400 | 184,35 |
| 32 | FC32D1X0600 | 50-600 | 184,35 |
| 32 | FC32D1X1000 | 100-1000 | 184,35 |
| 32 | FC32D1X1500 | 150-1500 | 184,35 |

FLOTADOR PP ROJO

| | | | |
|----|-------------|----------|--------|
| 16 | FC16D1M0015 | 1,5-15 | 151,05 |
| 16 | FC16D1M0020 | 2-20 | 151,05 |
| 16 | FC16D1M0050 | 5-50 | 151,05 |
| 16 | FC16D1M0100 | 10-100 | 151,05 |
| 16 | FC16D1M0150 | 15-150 | 151,05 |
| 20 | FC20D1M0025 | 2-25 | 158,74 |
| 20 | FC20D1M0050 | 5-50 | 158,74 |
| 20 | FC20D1M0100 | 10-100 | 158,74 |
| 20 | FC20D1M0150 | 15-150 | 158,74 |
| 20 | FC20D1M0200 | 20-200 | 158,74 |
| 20 | FC20D1M0320 | 30-320 | 158,74 |
| 25 | FC25D1M0080 | 8-80 | 166,41 |
| 25 | FC25D1M0150 | 15-150 | 166,41 |
| 25 | FC25D1M0200 | 20-200 | 166,41 |
| 25 | FC25D1M0350 | 30-350 | 166,41 |
| 25 | FC25D1M0650 | 50-650 | 166,41 |
| 32 | FC32D1M0200 | 20-200 | 184,35 |
| 32 | FC32D1M0300 | 30-300 | 184,35 |
| 32 | FC32D1M0600 | 60-600 | 184,35 |
| 32 | FC32D1M1000 | 100-1000 | 184,35 |

 Flujómetro corto para H₂O.

Densidad: 1 kg/l - 20° C. Cuerpo: TROGAMID. Juntas: EPDM.

FCIV
 encolar.

FLOTADOR INOX AISI 316 CON IMÁN INTERIOR incorporado para contacto exterior (suministrado aparte)

| Diámetro Encolar | Ref. Encolar | Escala l/h. | € |
|------------------|--------------|-------------|--------|
| 16 | FC16D1X0030M | 3-30 | 227,87 |
| 16 | FC16D1X0040M | 4-40 | 227,87 |
| 16 | FC16D1X0100M | 10-100 | 227,87 |
| 16 | FC16D1X0200M | 20-200 | 227,87 |
| 16 | FC16D1X0300M | 30-300 | 227,87 |
| 20 | FC20D1X0050M | 5-50 | 233,00 |
| 20 | FC20D1X0100M | 10-100 | 233,00 |
| 20 | FC20D1X0160M | 15-160 | 233,00 |
| 20 | FC20D1X0250M | 20-250 | 233,00 |
| 20 | FC20D1X0350M | 35-350 | 233,00 |
| 20 | FC20D1X0600M | 60-600 | 233,00 |
| 25 | FC25D1X0150M | 15-150 | 243,24 |
| 25 | FC25D1X0250M | 25-250 | 243,24 |
| 25 | FC25D1X0400M | 40-400 | 243,24 |
| 25 | FC25D1X0600M | 50-600 | 243,24 |
| 25 | FC25D1X1100M | 100-1100 | 243,24 |
| 32 | FC32D1X0400M | 40-400 | 273,96 |
| 32 | FC32D1X0600M | 50-600 | 273,96 |
| 32 | FC32D1X1000M | 100-1000 | 273,96 |
| 32 | FC32D1X1500M | 150-1500 | 273,96 |

FLOTADOR PP ROJO CON IMÁN INTERIOR incorporado para contacto exterior (suministrado aparte)

| | | | |
|----|--------------|----------|--------|
| 16 | FC16D1M0015M | 1,5-15 | 227,87 |
| 16 | FC16D1M0020M | 2-20 | 227,87 |
| 16 | FC16D1M0050M | 5-50 | 227,87 |
| 16 | FC16D1M0100M | 10-100 | 227,87 |
| 16 | FC16D1M0150M | 15-150 | 227,87 |
| 20 | FC20D1M0025M | 2-25 | 233,00 |
| 20 | FC20D1M0050M | 5-50 | 233,00 |
| 20 | FC20D1M0100M | 10-100 | 233,00 |
| 20 | FC20D1M0150M | 15-150 | 233,00 |
| 20 | FC20D1M0200M | 20-200 | 233,00 |
| 20 | FC20D1M0320M | 30-320 | 233,00 |
| 25 | FC25D1M0080M | 8-80 | 243,24 |
| 25 | FC25D1M0150M | 15-150 | 243,24 |
| 25 | FC25D1M0200M | 20-200 | 243,24 |
| 25 | FC25D1M0350M | 30-350 | 243,24 |
| 25 | FC25D1M0650M | 50-650 | 243,24 |
| 32 | FC32D1M0200M | 20-200 | 273,96 |
| 32 | FC32D1M0300M | 30-300 | 273,96 |
| 32 | FC32D1M0600M | 60-600 | 273,96 |
| 32 | FC32D1M1000M | 100-1000 | 273,96 |

 Flujómetro corto para H₂O.

Densidad: 1 kg/l - 20° C. Cuerpo: TROGAMID. Juntas: EPDM.

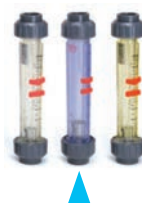
FCIV
 encolar.

FLOTADOR INOX AISI 316

| Diámetro Encolar | Ref. Encolar | Escala l/h. | € |
|------------------|--------------|-------------|--------|
| 16 | FC16T1X0030 | 3-30 | 145,92 |
| 16 | FC16T1X0040 | 4-40 | 145,92 |
| 16 | FC16T1X0100 | 10-100 | 145,92 |
| 16 | FC16T1X0200 | 20-200 | 145,92 |
| 16 | FC16T1X0300 | 30-300 | 145,92 |
| 20 | FC20T1X0050 | 5-50 | 153,63 |
| 20 | FC20T1X0100 | 10-100 | 153,63 |
| 20 | FC20T1X0160 | 15-160 | 153,63 |
| 20 | FC20T1X0250 | 20-250 | 153,63 |
| 20 | FC20T1X0350 | 35-350 | 153,63 |
| 20 | FC20T1X0600 | 60-600 | 153,63 |
| 25 | FC25T1X0150 | 15-150 | 161,33 |
| 25 | FC25T1X0250 | 25-250 | 161,33 |
| 25 | FC25T1X0400 | 40-400 | 161,33 |
| 25 | FC25T1X0600 | 50-600 | 161,33 |
| 25 | FC25T1X1100 | 100-1100 | 161,33 |
| 32 | FC32T1X0400 | 40-400 | 179,24 |
| 32 | FC32T1X0600 | 50-600 | 179,24 |
| 32 | FC32T1X1000 | 100-1000 | 179,24 |
| 32 | FC32T1X1500 | 150-1500 | 179,24 |

FLOTADOR PP ROJO

| | | | |
|----|-------------|----------|--------|
| 16 | FC16T1M0015 | 1,5-15 | 145,92 |
| 16 | FC16T1M0020 | 2-20 | 145,92 |
| 16 | FC16T1M0050 | 5-50 | 145,92 |
| 16 | FC16T1M0100 | 10-100 | 145,92 |
| 16 | FC16T1M0150 | 15-150 | 145,92 |
| 20 | FC20T1M0025 | 2-25 | 153,63 |
| 20 | FC20T1M0050 | 5-50 | 153,63 |
| 20 | FC20T1M0100 | 10-100 | 153,63 |
| 20 | FC20T1M0150 | 15-150 | 153,63 |
| 20 | FC20T1M0200 | 20-200 | 153,63 |
| 20 | FC20T1M0320 | 30-320 | 153,63 |
| 25 | FC25T1M0080 | 8-80 | 161,33 |
| 25 | FC25T1M0150 | 15-150 | 161,33 |
| 25 | FC25T1M0200 | 20-200 | 161,33 |
| 25 | FC25T1M0350 | 30-350 | 161,33 |
| 25 | FC25T1M0650 | 50-650 | 161,33 |
| 32 | FC32T1M0200 | 20-200 | 179,24 |
| 32 | FC32T1M0300 | 30-300 | 179,24 |
| 32 | FC32T1M0600 | 60-600 | 179,24 |
| 32 | FC32T1M1000 | 100-1000 | 179,24 |

 Flujómetro corto para H₂O.

Densidad: 1 kg/l - 20° C. Cuerpo: PVC Transparente. Juntas: EPDM.

FCIV
 encolar.



FLOTADOR INOX AISI 316 CON IMÁN INTERIOR incorporado para contacto exterior (suministrado aparte)

| Diámetro Encolar | Ref. Encolar | Escala l/h. | € |
|------------------|--------------|-------------|--------|
| 16 | FC16T1X0030M | 3-30 | 222,72 |
| 16 | FC16T1X0040M | 4-40 | 222,72 |
| 16 | FC16T1X0100M | 10-100 | 222,72 |
| 16 | FC16T1X0200M | 20-200 | 222,72 |
| 16 | FC16T1X0300M | 30-300 | 222,72 |
| 20 | FC20T1X0050M | 5-50 | 227,87 |
| 20 | FC20T1X0100M | 10-100 | 227,87 |
| 20 | FC20T1X0160M | 15-160 | 227,87 |
| 20 | FC20T1X0250M | 20-250 | 227,87 |
| 20 | FC20T1X0350M | 35-350 | 227,87 |
| 20 | FC20T1X0600M | 60-600 | 227,87 |
| 25 | FC25T1X0150M | 15-150 | 238,13 |
| 25 | FC25T1X0250M | 25-250 | 238,13 |
| 25 | FC25T1X0400M | 40-400 | 238,13 |
| 25 | FC25T1X0600M | 50-600 | 238,13 |
| 25 | FC25T1X1100M | 100-1100 | 238,13 |
| 32 | FC32T1X0400M | 40-400 | 268,83 |
| 32 | FC32T1X0600M | 50-600 | 268,83 |
| 32 | FC32T1X1000M | 100-1000 | 268,83 |
| 32 | FC32T1X1500M | 150-1500 | 268,83 |

FLOTADOR PP ROJO CON IMÁN INTERIOR incorporado para contacto exterior (suministrado aparte)

| | | | |
|----|--------------|----------|--------|
| 16 | FC16T1M0015M | 1,5-15 | 222,72 |
| 16 | FC16T1M0020M | 2-20 | 222,72 |
| 16 | FC16T1M0050M | 5-50 | 222,72 |
| 16 | FC16T1M0100M | 10-100 | 222,72 |
| 16 | FC16T1M0150M | 15-150 | 222,72 |
| 20 | FC20T1M0025M | 2-25 | 227,87 |
| 20 | FC20T1M0050M | 5-50 | 227,87 |
| 20 | FC20T1M0100M | 10-100 | 227,87 |
| 20 | FC20T1M0150M | 15-150 | 227,87 |
| 20 | FC20T1M0200M | 20-200 | 227,87 |
| 20 | FC20T1M0320M | 30-320 | 227,87 |
| 25 | FC25T1M0080M | 8-80 | 238,13 |
| 25 | FC25T1M0150M | 15-150 | 238,13 |
| 25 | FC25T1M0200M | 20-200 | 238,13 |
| 25 | FC25T1M0350M | 30-350 | 238,13 |
| 25 | FC25T1M0650M | 50-650 | 238,13 |
| 32 | FC32T1M0200M | 20-200 | 268,83 |
| 32 | FC32T1M0300M | 30-300 | 268,83 |
| 32 | FC32T1M0600M | 60-600 | 268,83 |
| 32 | FC32T1M1000M | 100-1000 | 268,83 |

Flujómetro corto para H₂O.

Densidad: 1 kg/l - 20° C. Cuerpo: PVC Transparente. Juntas: EPDM.

FCIV
 encolar.

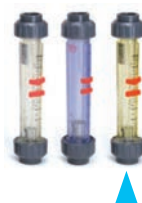

FLOTADOR INOX AISI 316

| Diámetro Encolar | Ref. Encolar | Escala l/h. | € |
|------------------|--------------|-------------|--------|
| 16 | FC16P1X0030 | 3-30 | 166,41 |
| 16 | FC16P1X0040 | 4-40 | 166,41 |
| 16 | FC16P1X0100 | 10-100 | 166,41 |
| 16 | FC16P1X0200 | 20-200 | 166,41 |
| 16 | FC16P1X0300 | 30-300 | 166,41 |
| 20 | FC20P1X0050 | 5-50 | 176,68 |
| 20 | FC20P1X0100 | 10-100 | 176,68 |
| 20 | FC20P1X0160 | 15-160 | 176,68 |
| 20 | FC20P1X0250 | 20-250 | 176,68 |
| 20 | FC20P1X0350 | 35-350 | 176,68 |
| 20 | FC20P1X0600 | 60-600 | 176,68 |
| 25 | FC25P1X0150 | 15-150 | 189,47 |
| 25 | FC25P1X0250 | 25-250 | 189,47 |
| 25 | FC25P1X0400 | 40-400 | 189,47 |
| 25 | FC25P1X0600 | 50-600 | 189,47 |
| 25 | FC25P1X1100 | 100-1100 | 189,47 |
| 32 | FC32P1X0400 | 40-400 | 212,54 |
| 32 | FC32P1X0600 | 50-600 | 212,54 |
| 32 | FC32P1X1000 | 100-1000 | 212,54 |
| 32 | FC32P1X1500 | 150-1500 | 212,54 |

FLOTADOR PP ROJO

| | | | |
|----|-------------|----------|--------|
| 16 | FC16P1M0015 | 1,5-15 | 166,41 |
| 16 | FC16P1M0020 | 2-20 | 166,41 |
| 16 | FC16P1M0050 | 5-50 | 166,41 |
| 16 | FC16P1M0100 | 10-100 | 166,41 |
| 16 | FC16P1M0150 | 15-150 | 166,41 |
| 20 | FC20P1M0025 | 2-25 | 176,68 |
| 20 | FC20P1M0050 | 5-50 | 176,68 |
| 20 | FC20P1M0100 | 10-100 | 176,68 |
| 20 | FC20P1M0150 | 15-150 | 176,68 |
| 20 | FC20P1M0200 | 20-200 | 176,68 |
| 20 | FC20P1M0320 | 30-320 | 176,68 |
| 25 | FC25P1M0080 | 8-80 | 189,47 |
| 25 | FC25P1M0150 | 15-150 | 189,47 |
| 25 | FC25P1M0200 | 20-200 | 189,47 |
| 25 | FC25P1M0350 | 30-350 | 189,47 |
| 25 | FC25P1M0650 | 50-650 | 189,47 |
| 32 | FC32P1M0200 | 20-200 | 212,54 |
| 32 | FC32P1M0300 | 30-300 | 212,54 |
| 32 | FC32P1M0600 | 60-600 | 212,54 |
| 32 | FC32P1M1000 | 100-1000 | 212,54 |

Flujómetro corto para H₂O.

Densidad: 1 kg/l - 20° C. Cuerpo: POLYSULFON Juntas: EPDM.

FCIV
 encolar.

FLOTADOR INOX AISI 316 CON IMÁN INTERIOR incorporado para contacto exterior (suministrado aparte)

| Diámetro Encolar | Ref. Encolar | Escala l/h. | € |
|------------------|--------------|-------------|--------|
| 16 | FC16P1X0030M | 3-30 | 245,81 |
| 16 | FC16P1X0040M | 4-40 | 245,81 |
| 16 | FC16P1X0100M | 10-100 | 245,81 |
| 16 | FC16P1X0200M | 20-200 | 245,81 |
| 16 | FC16P1X0300M | 30-300 | 245,81 |
| 20 | FC20P1X0050M | 5-50 | 253,47 |
| 20 | FC20P1X0100M | 10-100 | 253,47 |
| 20 | FC20P1X0160M | 15-160 | 253,47 |
| 20 | FC20P1X0250M | 20-250 | 253,47 |
| 20 | FC20P1X0350M | 35-350 | 253,47 |
| 20 | FC20P1X0600M | 60-600 | 253,47 |
| 25 | FC25P1X0150M | 15-150 | 266,29 |
| 25 | FC25P1X0250M | 25-250 | 266,29 |
| 25 | FC25P1X0400M | 40-400 | 266,29 |
| 25 | FC25P1X0600M | 50-600 | 266,29 |
| 25 | FC25P1X1100M | 100-1100 | 266,29 |
| 32 | FC32P1X0400M | 40-400 | 302,13 |
| 32 | FC32P1X0600M | 50-600 | 302,13 |
| 32 | FC32P1X1000M | 100-1000 | 302,13 |
| 32 | FC32P1X1500M | 150-1500 | 302,13 |

FLOTADOR PP ROJO CON IMÁN INTERIOR incorporado para contacto exterior (suministrado aparte)

| | | | |
|----|--------------|----------|--------|
| 16 | FC16P1M0015M | 1,5-15 | 245,81 |
| 16 | FC16P1M0020M | 2-20 | 245,81 |
| 16 | FC16P1M0050M | 5-50 | 245,81 |
| 16 | FC16P1M0100M | 10-100 | 245,81 |
| 16 | FC16P1M0150M | 15-150 | 245,81 |
| 20 | FC20P1M0025M | 2-25 | 253,47 |
| 20 | FC20P1M0050M | 5-50 | 253,47 |
| 20 | FC20P1M0100M | 10-100 | 253,47 |
| 20 | FC20P1M0150M | 15-150 | 253,47 |
| 20 | FC20P1M0200M | 20-200 | 253,47 |
| 20 | FC20P1M0320M | 30-320 | 253,47 |
| 25 | FC25P1M0080M | 8-80 | 266,29 |
| 25 | FC25P1M0150M | 15-150 | 266,29 |
| 25 | FC25P1M0200M | 20-200 | 266,29 |
| 25 | FC25P1M0350M | 30-350 | 266,29 |
| 25 | FC25P1M0650M | 50-650 | 266,29 |
| 32 | FC32P1M0200M | 20-200 | 302,13 |
| 32 | FC32P1M0300M | 30-300 | 302,13 |
| 32 | FC32P1M0600M | 60-600 | 302,13 |
| 32 | FC32P1M1000M | 100-1000 | 302,13 |

Flujómetro corto para H₂O.

Densidad: 1 kg/l - 20° C. Cuerpo: POLYSULFON. Juntas: EPDM.

FCIV
 encolar.



FLOTADOR INOX AISI 316

| Diámetro Encolar | Ref. Encolar | Escala l/h. | € |
|------------------|--------------|-------------|--------|
| 16 | FC16T3X0085 | 0,5-8,5 | 145,92 |
| 16 | FC16T3X0040 | 2,5-40 | 145,92 |
| 16 | FC16T3X0120 | 10-120 | 145,92 |
| 16 | FC16T3X0180 | 15-180 | 145,92 |
| 20 | FC20T3X0375 | 2,5-37,5 | 153,63 |
| 20 | FC20T3X0075 | 4-75 | 153,63 |
| 20 | FC20T3X0140 | 5-140 | 153,63 |
| 20 | FC20T3X0220 | 9-220 | 153,63 |
| 20 | FC20T3X0360 | 24-360 | 153,63 |
| 25 | FC25T3X0135 | 6-135 | 161,33 |
| 25 | FC25T3X0230 | 13-230 | 161,33 |
| 25 | FC25T3X0350 | 20-350 | 161,33 |
| 25 | FC25T3X0650 | 25-650 | 161,33 |
| 32 | FC32T3X0220 | 10-220 | 179,24 |
| 32 | FC32T3X0350 | 20-350 | 179,24 |
| 32 | FC32T3X0650 | 25-650 | 179,24 |
| 32 | FC32T3X1000 | 50-1000 | 179,24 |

FLOTADOR PP ROJO

| | | | |
|----|-------------|---------|--------|
| 16 | FC16T3M0003 | 0,25-3 | 145,92 |
| 16 | FC16T3M0017 | 1-17 | 145,92 |
| 16 | FC16T3M0045 | 2,5-45 | 145,92 |
| 16 | FC16T3M0075 | 5-75 | 145,92 |
| 20 | FC20T3M0125 | 1-12,5 | 153,63 |
| 20 | FC20T3M0034 | 2-34 | 153,63 |
| 20 | FC20T3M0063 | 2,5-63 | 153,63 |
| 20 | FC20T3M0104 | 5-104 | 153,63 |
| 20 | FC20T3M0170 | 10-170 | 153,63 |
| 25 | FC25T3M0060 | 3,5-60 | 161,33 |
| 25 | FC25T3M0092 | 5-92 | 161,33 |
| 25 | FC25T3M0165 | 8-165 | 161,33 |
| 25 | FC25T3M0380 | 20-380 | 161,33 |
| 32 | FC32T3M0090 | 5-90 | 179,24 |
| 32 | FC32T3M0150 | 7,5-150 | 179,24 |
| 32 | FC32T3M0360 | 20-360 | 179,24 |
| 32 | FC32T3M0650 | 25-650 | 179,24 |

Flujómetro corto para **Hidróxido de sodio (NaOH) 30%..**

Densidad: 1,33 kg/l - 20° C. Cuerpo **PVC Transparente**. Juntas: **EPDM**.

FCIV
 encolar.

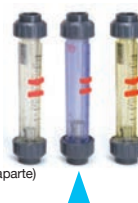

FLOTADOR INOX AISI 316 CON IMÁN INTERIOR incorporado para contacto exterior (suministrado aparte)

| Diámetro Encolar | Ref. Encolar | Escala l/h. | € |
|------------------|--------------|-------------|--------|
| 16 | FC16T3X0085M | 0,5-8,5 | 222,72 |
| 16 | FC16T3X0040M | 2,5-40 | 222,72 |
| 16 | FC16T3X0120M | 10-120 | 222,72 |
| 16 | FC16T3X0180M | 15-180 | 222,72 |
| 20 | FC20T3X0375M | 2,5-37,5 | 227,87 |
| 20 | FC20T3X0075M | 4-75 | 227,87 |
| 20 | FC20T3X0140M | 5-140 | 227,87 |
| 20 | FC20T3X0220M | 9-220 | 227,87 |
| 20 | FC20T3X0360M | 24-360 | 227,87 |
| 25 | FC25T3X0135M | 6-135 | 238,13 |
| 25 | FC25T3X0230M | 13-230 | 238,13 |
| 25 | FC25T3X0350M | 20-350 | 238,13 |
| 25 | FC25T3X0650M | 25-650 | 238,13 |
| 32 | FC32T3X0220M | 10-220 | 268,83 |
| 32 | FC32T3X0350M | 20-350 | 268,83 |
| 32 | FC32T3X0650M | 25-650 | 268,83 |
| 32 | FC32T3X1000M | 50-1000 | 268,83 |

FLOTADOR PP ROJO CON IMÁN INTERIOR incorporado para contacto exterior (suministrado aparte)

| | | | |
|----|--------------|---------|--------|
| 16 | FC16T3M0003M | 0,25-3 | 222,72 |
| 16 | FC16T3M0017M | 1-17 | 222,72 |
| 16 | FC16T3M0045M | 2,5-45 | 222,72 |
| 16 | FC16T3M0075M | 5-75 | 222,72 |
| 20 | FC20T3M0125M | 1-12,5 | 227,87 |
| 20 | FC20T3M0034M | 2-34 | 227,87 |
| 20 | FC20T3M0063M | 2,5-63 | 227,87 |
| 20 | FC20T3M0104M | 5-104 | 227,87 |
| 20 | FC20T3M0170M | 10-170 | 227,87 |
| 25 | FC25T3M0060M | 3,5-60 | 238,13 |
| 25 | FC25T3M0092M | 5-92 | 238,13 |
| 25 | FC25T3M0165M | 8-165 | 238,13 |
| 25 | FC25T3M0380M | 20-380 | 238,13 |
| 32 | FC32T3M0090M | 5-90 | 268,83 |
| 32 | FC32T3M0150M | 7,5-150 | 268,83 |
| 32 | FC32T3M0360M | 20-360 | 268,83 |
| 32 | FC32T3M0650M | 25-650 | 268,83 |

Flujómetro corto para **Hidróxido de sodio (NaOH) 30%..**

Densidad: 1,33 kg/l - 20° C. Cuerpo **PVC Transparente**. Juntas: **EPDM**.

FCIV
 encolar.



FLOTADOR INOX AISI 316

| Diámetro Encolar | Ref. Encolar | Escala l/h. | € |
|------------------|--------------|-------------|--------|
| 16 | FC16P3X0085 | 0,5-8,5 | 166,41 |
| 16 | FC16P3X0040 | 2,5-40 | 166,41 |
| 16 | FC16P3X0120 | 10-120 | 166,41 |
| 16 | FC16P3X0180 | 15-180 | 166,41 |
| 20 | FC20P3X0375 | 2,5-37,5 | 176,68 |
| 20 | FC20P3X0075 | 4-75 | 176,68 |
| 20 | FC20P3X0140 | 5-140 | 176,68 |
| 20 | FC20P3X0220 | 9-220 | 176,68 |
| 20 | FC20P3X0360 | 24-360 | 176,68 |
| 25 | FC25P3X0135 | 6-135 | 189,47 |
| 25 | FC25P3X0230 | 13-230 | 189,47 |
| 25 | FC25P3X0350 | 20-350 | 189,47 |
| 25 | FC25P3X0650 | 25-650 | 189,47 |
| 32 | FC32P3X0220 | 10-220 | 212,54 |
| 32 | FC32P3X0350 | 20-350 | 212,54 |
| 32 | FC32P3X0650 | 25-650 | 212,54 |
| 32 | FC32P3X1000 | 50-1000 | 212,54 |

FLOTADOR PP ROJO

| | | | |
|----|-------------|---------|--------|
| 16 | FC16P3M0003 | 0,25-3 | 166,41 |
| 16 | FC16P3M0017 | 1-17 | 166,41 |
| 16 | FC16P3M0045 | 2,5-45 | 166,41 |
| 16 | FC16P3M0075 | 5-75 | 166,41 |
| 20 | FC20P3M0125 | 1-12,5 | 176,68 |
| 20 | FC20P3M0034 | 2-34 | 176,68 |
| 20 | FC20P3M0063 | 2,5-63 | 176,68 |
| 20 | FC20P3M0104 | 5-104 | 176,68 |
| 20 | FC20P3M0170 | 10-170 | 176,68 |
| 25 | FC25P3M0060 | 3,5-60 | 189,47 |
| 25 | FC25P3M0092 | 5-92 | 189,47 |
| 25 | FC25P3M0165 | 8-165 | 189,47 |
| 25 | FC25P3M0380 | 20-380 | 189,47 |
| 32 | FC32P3M0090 | 5-90 | 212,54 |
| 32 | FC32P3M0150 | 7,5-150 | 212,54 |
| 32 | FC32P3M0360 | 20-360 | 212,54 |
| 32 | FC32P3M0650 | 25-650 | 212,54 |

Flujómetro corto para **Hidróxido de sodio (NaOH) 30%..**

Densidad: 1,33 kg/l - 20° C. Cuerpo **POLYSULFON..** Juntas: **EPDM.**

FCIV
 encolar.

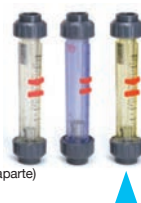

FLOTADOR INOX AISI 316 CON IMÁN INTERIOR incorporado para contacto exterior (suministrado aparte)

| Diámetro Encolar | Ref. Encolar | Escala l/h. | € |
|------------------|--------------|-------------|--------|
| 16 | FC16P3X0085M | 0,5-8,5 | 245,81 |
| 16 | FC16P3X0040M | 2,5-40 | 245,81 |
| 16 | FC16P3X0120M | 10-120 | 245,81 |
| 16 | FC16P3X0180M | 15-180 | 245,81 |
| 20 | FC20P3X0375M | 2,5-37,5 | 253,47 |
| 20 | FC20P3X0075M | 4-75 | 253,47 |
| 20 | FC20P3X0140M | 5-140 | 253,47 |
| 20 | FC20P3X0220M | 9-220 | 253,47 |
| 20 | FC20P3X0360M | 24-360 | 253,47 |
| 25 | FC25P3X0135M | 6-135 | 266,29 |
| 25 | FC25P3X0230M | 13-230 | 266,29 |
| 25 | FC25P3X0350M | 20-350 | 266,29 |
| 25 | FC25P3X0650M | 25-650 | 266,29 |
| 32 | FC32P3X0220M | 10-220 | 302,13 |
| 32 | FC32P3X0350M | 20-350 | 302,13 |
| 32 | FC32P3X0650M | 25-650 | 302,13 |
| 32 | FC32P3X1000M | 50-1000 | 302,13 |

FLOTADOR PP ROJO CON IMÁN INTERIOR incorporado para contacto exterior (suministrado aparte)

| | | | |
|----|--------------|---------|--------|
| 16 | FC16P3M0003M | 0,25-3 | 245,81 |
| 16 | FC16P3M0017M | 1-17 | 245,81 |
| 16 | FC16P3M0045M | 2,5-45 | 245,81 |
| 16 | FC16P3M0075M | 5-75 | 245,81 |
| 20 | FC20P3M0125M | 1-12,5 | 253,47 |
| 20 | FC20P3M0034M | 2-34 | 253,47 |
| 20 | FC20P3M0063M | 2,5-63 | 253,47 |
| 20 | FC20P3M0104M | 5-104 | 253,47 |
| 20 | FC20P3M0170M | 10-170 | 253,47 |
| 25 | FC25P3M0060M | 3,5-60 | 266,29 |
| 25 | FC25P3M0092M | 5-92 | 266,29 |
| 25 | FC25P3M0165M | 8-165 | 266,29 |
| 25 | FC25P3M0380M | 20-380 | 266,29 |
| 32 | FC32P3M0090M | 5-90 | 302,13 |
| 32 | FC32P3M0150M | 7,5-150 | 302,13 |
| 32 | FC32P3M0360M | 20-360 | 302,13 |
| 32 | FC32P3M0650M | 25-650 | 302,13 |

Flujómetro corto para **Hidróxido de sodio (NaOH) 30%..**

Densidad: 1,33 kg/l - 20° C. Cuerpo **POLYSULFON**. Juntas: **EPDM**.

FCIV
 encolar.



FLOTADOR INOX AISI 316

| Diámetro Encolar | Ref. Encolar | Escala l/h. | € |
|------------------|--------------|-------------|--------|
| 16 | FC16T5X0014 | 0,05-1,4 | 145,92 |
| 16 | FC16T5X0008 | 0,5-8 | 145,92 |
| 16 | FC16T5X0040 | 2,5-40 | 145,92 |
| 16 | FC16T5X0055 | 4-55 | 145,92 |
| 20 | FC20T5X0065 | 0,25-6,5 | 153,63 |
| 20 | FC20T5X0015 | 1-15 | 153,63 |
| 20 | FC20T5X0036 | 2-36 | 153,63 |
| 20 | FC20T5X0075 | 4-75 | 153,63 |
| 20 | FC20T5X0140 | 6-140 | 153,63 |
| 25 | FC25T5X0030 | 2,5-30 | 161,33 |
| 25 | FC25T5X0065 | 3-65 | 161,33 |
| 25 | FC25T5X0135 | 4-135 | 161,33 |
| 25 | FC25T5X0320 | 20-320 | 161,33 |
| 32 | FC32T5X0055 | 2,5-55 | 179,24 |
| 32 | FC32T5X0125 | 5-125 | 179,24 |
| 32 | FC32T5X0300 | 20-300 | 179,24 |
| 32 | FC32T5X0600 | 25-600 | 179,24 |

FLOTADOR PP ROJO

| | | | |
|----|-------------|-----------|--------|
| 16 | FC16T5M0005 | 0,025-0,5 | 145,92 |
| 16 | FC16T5M0275 | 0,25-2,75 | 145,92 |
| 16 | FC16T5M0009 | 0,5-9 | 145,92 |
| 16 | FC16T5M0021 | 1-21 | 145,92 |
| 20 | FC20T5M0002 | 0,1-2 | 153,63 |
| 20 | FC20T5M0055 | 0,25-5,5 | 153,63 |
| 20 | FC20T5M0125 | 0,5-12,5 | 153,63 |
| 20 | FC20T5M0255 | 2-25,5 | 153,63 |
| 20 | FC20T5M0475 | 2,5-47,5 | 153,63 |
| 25 | FC25T5M0010 | 1-10 | 161,33 |
| 25 | FC25T5M0019 | 1-19 | 161,33 |
| 25 | FC25T5M0045 | 2-45 | 161,33 |
| 25 | FC25T5M0130 | 4-130 | 161,33 |
| 32 | FC32T5M0015 | 1-15 | 179,24 |
| 32 | FC32T5M0040 | 2-40 | 179,24 |
| 32 | FC32T5M0110 | 5-110 | 179,24 |
| 32 | FC32T5M0260 | 10-260 | 179,24 |

Flujómetro corto para **Hidróxido de sodio (NaOH) 50%..**

Densidad: 1,53 kg/l - 20° C. Cuerpo **PVC Transparente**. Juntas: **EPDM**.

FCIV
 encolar.



FLOTADOR INOX AISI 316 CON IMÁN INTERIOR incorporado para contacto exterior (suministrado aparte)

| Diámetro Encolar | Ref. Encolar | Escala l/h. | € |
|------------------|--------------|-------------|--------|
| 16 | FC16T5X0014M | 0,05-1,4 | 222,72 |
| 16 | FC16T5X0008M | 0,5-8 | 222,72 |
| 16 | FC16T5X0040M | 2,5-40 | 222,72 |
| 16 | FC16T5X0055M | 4-55 | 222,72 |
| 20 | FC20T5X0065M | 0,25-6,5 | 227,87 |
| 20 | FC20T5X0015M | 1-15 | 227,87 |
| 20 | FC20T5X0036M | 2-36 | 227,87 |
| 20 | FC20T5X0075M | 4-75 | 227,87 |
| 20 | FC20T5X0140M | 6-140 | 227,87 |
| 25 | FC25T5X0030M | 2,5-30 | 238,13 |
| 25 | FC25T5X0065M | 3-65 | 238,13 |
| 25 | FC25T5X0135M | 4-135 | 238,13 |
| 25 | FC25T5X0320M | 20-320 | 238,13 |
| 32 | FC32T5X0055M | 2,5-55 | 268,83 |
| 32 | FC32T5X0125M | 5-125 | 268,83 |
| 32 | FC32T5X0300M | 20-300 | 268,83 |
| 32 | FC32T5X0600M | 25-600 | 268,83 |

FLOTADOR PP ROJO CON IMÁN INTERIOR incorporado para contacto exterior (suministrado aparte)

| | | | |
|----|--------------|-----------|--------|
| 16 | FC16T5M0005M | 0,025-0,5 | 222,72 |
| 16 | FC16T5M0275M | 0,25-2,75 | 222,72 |
| 16 | FC16T5M0009M | 0,5-9 | 222,72 |
| 16 | FC16T5M0021M | 1-21 | 222,72 |
| 20 | FC20T5M0002M | 0,1-2 | 227,87 |
| 20 | FC20T5M0055M | 0,25-5,5 | 227,87 |
| 20 | FC20T5M0125M | 0,5-12,5 | 227,87 |
| 20 | FC20T5M0255M | 2-25,5 | 227,87 |
| 20 | FC20T5M0475M | 2,5-47,5 | 227,87 |
| 25 | FC25T5M0010M | 1-10 | 238,13 |
| 25 | FC25T5M0019M | 1-19 | 238,13 |
| 25 | FC25T5M0045M | 2-45 | 238,13 |
| 25 | FC25T5M0130M | 4-130 | 238,13 |
| 32 | FC32T5M0015M | 1-15 | 268,83 |
| 32 | FC32T5M0040M | 2-40 | 268,83 |
| 32 | FC32T5M0110M | 5-110 | 268,83 |
| 32 | FC32T5M0260M | 10-260 | 268,83 |

Flujómetro corto para **Hidróxido de sodio (NaOH) 50%..**

Densidad: 1,53 kg/l - 20° C. Cuerpo **PVC Transparente**. Juntas: **EPDM**.

FCIV
 encolar.

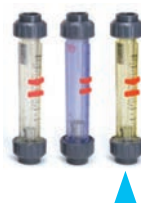

FLOTADOR INOX AISI 316

| Diámetro Encolar | Ref. Encolar | Escala l/h. | € |
|------------------|--------------|-------------|--------|
| 16 | FC16P5X0014 | 0,05-1,4 | 166,41 |
| 16 | FC16P5X0008 | 0,5-8 | 166,41 |
| 16 | FC16P5X0040 | 2,5-40 | 166,41 |
| 16 | FC16P5X0055 | 4-55 | 166,41 |
| 20 | FC20P5X0065 | 0,25-6,5 | 176,68 |
| 20 | FC20P5X0015 | 1-15 | 176,68 |
| 20 | FC20P5X0036 | 2-36 | 176,68 |
| 20 | FC20P5X0075 | 4-75 | 176,68 |
| 20 | FC20P5X0140 | 6-140 | 176,68 |
| 25 | FC25P5X0030 | 2,5-30 | 189,47 |
| 25 | FC25P5X0065 | 3-65 | 189,47 |
| 25 | FC25P5X0135 | 4-135 | 189,47 |
| 25 | FC25P5X0320 | 20-320 | 189,47 |
| 32 | FC32P5X0055 | 2,5-55 | 212,54 |
| 32 | FC32P5X0125 | 5-125 | 212,54 |
| 32 | FC32P5X0300 | 20-300 | 212,54 |
| 32 | FC32P5X0600 | 25-600 | 212,54 |

FLOTADOR PP ROJO

| | | | |
|----|-------------|-----------|--------|
| 16 | FC16P5M0005 | 0,025-0,5 | 166,41 |
| 16 | FC16P5M0275 | 0,25-2,75 | 166,41 |
| 16 | FC16P5M0009 | 0,5-9 | 166,41 |
| 16 | FC16P5M0021 | 1-21 | 166,41 |
| 20 | FC20P5M0002 | 0,1-2 | 176,68 |
| 20 | FC20P5M0055 | 0,25-5,5 | 176,68 |
| 20 | FC20P5M0125 | 0,5-12,5 | 176,68 |
| 20 | FC20P5M0255 | 2-25,5 | 176,68 |
| 20 | FC20P5M0475 | 2,5-47,5 | 176,68 |
| 25 | FC25P5M0010 | 1-10 | 189,47 |
| 25 | FC25P5M0019 | 1-19 | 189,47 |
| 25 | FC25P5M0045 | 2-45 | 189,47 |
| 25 | FC25P5M0130 | 4-130 | 189,47 |
| 32 | FC32P5M0015 | 1-15 | 212,54 |
| 32 | FC32P5M0040 | 2-40 | 212,54 |
| 32 | FC32P5M0110 | 5-110 | 212,54 |
| 32 | FC32P5M0260 | 10-260 | 212,54 |

Flujómetro corto para **Hidróxido de sodio (NaOH) 50%..**

Densidad: 1,53 kg/l - 20° C. Cuerpo **POLYSULFON..** Juntas: **EPDM.**

FCIV
 encolar.



FLOTADOR INOX AISI 316 CON IMÁN INTERIOR incorporado para contacto exterior (suministrado aparte)

| Diámetro Encolar | Ref. Encolar | Escala l/h. | € |
|------------------|--------------|-------------|--------|
| 16 | FC16P5X0014M | 0,05-1,4 | 245,81 |
| 16 | FC16P5X0008M | 0,5-8 | 245,81 |
| 16 | FC16P5X0040M | 2,5-40 | 245,81 |
| 16 | FC16P5X0055M | 4-55 | 245,81 |
| 20 | FC20P5X0065M | 0,25-6,5 | 253,47 |
| 20 | FC20P5X0015M | 1-15 | 253,47 |
| 20 | FC20P5X0036M | 2-36 | 253,47 |
| 20 | FC20P5X0075M | 4-75 | 253,47 |
| 20 | FC20P5X0140M | 6-140 | 253,47 |
| 25 | FC25P5X0030M | 2,5-30 | 266,29 |
| 25 | FC25P5X0065M | 3-65 | 266,29 |
| 25 | FC25P5X0135M | 4-135 | 266,29 |
| 25 | FC25P5X0320M | 20-320 | 266,29 |
| 32 | FC32P5X0055M | 2,5-55 | 302,13 |
| 32 | FC32P5X0125M | 5-125 | 302,13 |
| 32 | FC32P5X0300M | 20-300 | 302,13 |
| 32 | FC32P5X0600M | 25-600 | 302,13 |

FLOTADOR PP ROJO CON IMÁN INTERIOR incorporado para contacto exterior (suministrado aparte)

| | | | |
|----|--------------|-----------|--------|
| 16 | FC16P5M0005M | 0,025-0,5 | 245,81 |
| 16 | FC16P5M0275M | 0,25-2,75 | 245,81 |
| 16 | FC16P5M0009M | 0,5-9 | 245,81 |
| 16 | FC16P5M0021M | 1-21 | 245,81 |
| 20 | FC20P5M0002M | 0,1-2 | 253,47 |
| 20 | FC20P5M0055M | 0,25-5,5 | 253,47 |
| 20 | FC20P5M0125M | 0,5-12,5 | 253,47 |
| 20 | FC20P5M0255M | 2-25,5 | 253,47 |
| 20 | FC20P5M0475M | 2,5-47,5 | 253,47 |
| 25 | FC25P5M0010M | 1-10 | 266,29 |
| 25 | FC25P5M0019M | 1-19 | 266,29 |
| 25 | FC25P5M0045M | 2-45 | 266,29 |
| 25 | FC25P5M0130M | 4-130 | 266,29 |
| 32 | FC32P5M0015M | 1-15 | 302,13 |
| 32 | FC32P5M0040M | 2-40 | 302,13 |
| 32 | FC32P5M0110M | 5-110 | 302,13 |
| 32 | FC32P5M0260M | 10-260 | 302,13 |

Flujómetro corto para **Hidróxido de sodio (NaOH) 50%..**

Densidad: 1,53 kg/l - 20° C. Cuerpo **POLYSULFON**. Juntas: **EPDM**.

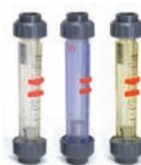
FCIV
 encolar.

FLOTADOR PP ROJO

| Diámetro Encolar | Ref. Encolar | Escala l/h. | € |
|------------------|--------------|-------------|--------|
| 16 | FC16T2M0014 | 1,4-14 | 151,05 |
| 16 | FC16T2M0018 | 2-18 | 151,05 |
| 16 | FC16T2M0045 | 5-45 | 151,05 |
| 16 | FC16T2M0090 | 10-90 | 151,05 |
| 16 | FC16T2M0140 | 14-140 | 151,07 |
| 20 | FC20T2M0023 | 2-23 | 158,74 |
| 20 | FC20T2M0045 | 5-45 | 158,74 |
| 20 | FC20T2M0090 | 10-90 | 158,74 |
| 20 | FC20T2M0140 | 14-140 | 158,74 |
| 20 | FC20T2M0185 | 19-185 | 158,74 |
| 20 | FC20T2M0300 | 30-300 | 158,74 |
| 25 | FC25T2M0075 | 7,5-75 | 166,41 |
| 25 | FC25T2M0140 | 14-140 | 166,41 |
| 25 | FC25T2M0185 | 19-185 | 166,41 |
| 25 | FC25T2M0325 | 30-325 | 166,41 |
| 25 | FC25T2M0600 | 45-600 | 166,41 |
| 32 | FC32T2M0185 | 19-185 | 194,60 |
| 32 | FC32T2M0280 | 28-280 | 194,60 |
| 32 | FC32T2M0550 | 55-500 | 194,60 |
| 32 | FC32T2M0900 | 90-900 | 194,60 |

FLOTADOR PP ROJO CON IMÁN INTERIOR incorporado para contacto exterior (suministrado aparte)

| | | | |
|----|--------------|--------|--------|
| 16 | FC16T2M0014M | 1,4-14 | 227,87 |
| 16 | FC16T2M0018M | 2-18 | 227,87 |
| 16 | FC16T2M0045M | 5-45 | 227,87 |
| 16 | FC16T2M0090M | 10-90 | 227,87 |
| 16 | FC16T2M0140M | 14-140 | 227,87 |
| 20 | FC20T2M0023M | 2-23 | 233,00 |
| 20 | FC20T2M0045M | 5-45 | 233,00 |
| 20 | FC20T2M0090M | 10-90 | 233,00 |
| 20 | FC20T2M0140M | 14-140 | 233,00 |
| 20 | FC20T2M0185M | 19-185 | 233,00 |
| 20 | FC20T2M0300M | 30-300 | 233,00 |
| 25 | FC25T2M0075M | 7,5-75 | 243,24 |
| 25 | FC25T2M0140M | 14-140 | 243,24 |
| 25 | FC25T2M0185M | 19-185 | 243,24 |
| 25 | FC25T2M0325M | 30-325 | 243,24 |
| 25 | FC25T2M0600M | 45-600 | 243,24 |
| 32 | FC32T2M0185M | 19-185 | 284,21 |
| 32 | FC32T2M0280M | 28-280 | 284,21 |
| 32 | FC32T2M0550M | 55-500 | 284,21 |
| 32 | FC32T2M0900M | 90-900 | 284,21 |

 Flujómetro corto para **Ácido clorhídrico (HCl) 30-33%**.

 Densidad: 1.16 kg/l - 20° C. Cuerpo: **PVC Transparente**. Juntas: **EPDM**.

FCIV
 encolar.



FLOTADOR PP ROJO

| Diámetro Encolar | Ref. Encolar | Escala Nm³/h | € |
|------------------|--------------------|--------------|---------------|
| 16 | FC16D0M0025 | 0,025-0,25 | 163,91 |
| 16 | FC16D0M0004 | 0,04-0,4 | 163,91 |
| 16 | FC16D0M0001 | 0,1-1 | 163,91 |
| 16 | FC16D0M0002 | 0,2-2 | 163,91 |
| 20 | FC20D0M0045 | 0,045-0,45 | 168,99 |
| 20 | FC20D0M0009 | 0,09-0,9 | 168,99 |
| 20 | FC20D0M0015 | 0,15-1,5 | 168,99 |
| 20 | FC20D0M0025 | 0,25-2,5 | 168,99 |
| 20 | FC20D0M0038 | 0,38-3,8 | 168,99 |
| 20 | FC20D0M0048 | 0,4-4,8 | 168,99 |
| 25 | FC25D0M0012 | 0,12-1,2 | 179,24 |
| 25 | FC25D0M0025 | 0,3-2,5 | 179,24 |
| 25 | FC25D0M0045 | 0,45-4,5 | 179,24 |
| 25 | FC25D0M0065 | 0,6-6,5 | 179,24 |
| 25 | FC25D0M0011 | 1,1-11 | 179,24 |
| 32 | FC32D0M0004 | 0,6-4 | 197,14 |
| 32 | FC32D0M0007 | 0,7-7 | 197,14 |
| 32 | FC32D0M0011 | 1,1-11 | 197,14 |
| 32 | FC32D0M0014 | 2-14 | 197,14 |

Flujómetro corto para **Aire**.

Densidad: 1,013 bar abs..- 20º Cuerpo: **TROGAMID**. Juntas: **EPDM**.



| Ref. | Descripción | € |
|----------------|--|------------------|
| MSMIN02 | Contacto de MÍNIMA para diámetros 16-20-25 * | 195,54 |
| MSMAX02 | Contacto de MAXIMA para diámetros 16-20-25 * | 195,54 |
| MSMIN01 | Contacto de MÍNIMA para diámetros 32 * | 195,54 |
| MSMAX01 | Contacto de MAXIMA para diámetros 32 * | 195,54 |
| | Escala especial | Consultar |
| | Doble escala | Consultar |

Contactos exteriores.

Sólo utilizables con flujómetros que incorporen imán exterior.

* Para usar con flotador con imán incorporado.



| d | Ref. | Descripción | € |
|----|-----------------|----------------|--------------|
| 16 | QBIC016 | Manguito C-PVC | 10,22 |
| 20 | QBIC020 | Manguito C-PVC | 10,17 |
| 25 | QBIC025 | Manguito C-PVC | 11,89 |
| 32 | QBIC032 | Manguito C-PVC | 15,45 |
| 20 | QBIGM020 | Manguito PP-H | 4,34 |
| 25 | QBIGM025 | Manguito PP-H | 4,39 |
| 32 | QBIGM032 | Manguito PP-H | 4,70 |
| 20 | QBIGF020 | Manguito PVDF | 16,80 |
| 25 | QBIGF025 | Manguito PVDF | 21,73 |
| 32 | QBIGF032 | Manguito PVDF | 24,22 |

Manguitos.

Para cada flujómetro es necesario pedir 2 manguitos.

| | | | |
|----|----------------|--------------|--------------|
| 16 | EFC034 | Tuerca C-PVC | 8,16 |
| 20 | EFC100 | Tuerca C-PVC | 6,80 |
| 25 | EFC114 | Tuerca C-PVC | 7,92 |
| 32 | EFC112 | Tuerca C-PVC | 15,26 |
| 20 | EFGM100 | Tuerca PP-H | 8,27 |
| 25 | EFGM114 | Tuerca PP-H | 8,56 |
| 32 | EFGM112 | Tuerca PP-H | 9,93 |
| 20 | EFGF100 | Tuerca PVDF | 27,71 |
| 25 | EFGF114 | Tuerca PVDF | 37,79 |
| 32 | EFGF112 | Tuerca PVDF | 46,88 |

Tuercas.

Para cada flujómetro es necesario pedir 2 tuercas.

| | | | |
|----|----------------|-----------|--------------|
| 16 | OR3062F | Junta FKM | 4,93 |
| 20 | OR4081F | Junta FKM | 15,16 |
| 25 | OR4112F | Junta FKM | 2,85 |
| 32 | OR4131F | Junta FKM | 8,05 |

Juntas.

Para cada flujómetro es necesario pedir 2 juntas.

Bajo pedido disponemos también de conexiones rosca hembra de 3/8" a 1" en acero inoxidable AISI 316 y en acero al carbono.

FSIV
encolar.

FLOTADOR INOX AISI 316

| Diámetro Encolar | Ref. Encolar | Escala l/h. | € |
|------------------|--------------------|-------------|-----------------|
| 25 | FS25D1X0250 | 25-250 | 247,22 |
| 25 | FS25D1X0400 | 40-400 | 247,22 |
| 25 | FS25D1X0640 | 60-640 | 247,22 |
| 25 | FS25D1X1000 | 100-1000 | 247,22 |
| 32 | FS32D1X0400 | 40-400 | 281,77 |
| 32 | FS32D1X0640 | 60-640 | 281,77 |
| 32 | FS32D1X1000 | 100-1000 | 281,77 |
| 32 | FS32D1X1600 | 150-1600 | 281,77 |
| 40 | FS40D1X1600 | 150-1600 | 379,49 |
| 40 | FS40D1X2500 | 200-2500 | 379,49 |
| 40 | FS40D1X4000 | 400-4000 | 379,49 |
| 50 | FS50D1X2500 | 200-2500 | 448,46 |
| 50 | FS50D1X4000 | 400-4000 | 448,46 |
| 50 | FS50D1X5000 | 500-5000 | 448,46 |
| 63 | FS63D1X4000 | 400-4000 | 600,85 |
| 63 | FS63D1X6000 | 600-6000 | 600,85 |
| 63 | FS63D1X0010 | 1000-10000 | 600,85 |
| 75 | FS75D1X0015 | 1500-15000 | 1.043,63 |
| 75 | FS75D1X0020 | 2000-20000 | 1.043,63 |
| 75 | FS75D1X0050 | 10000-50000 | 1.043,63 |

FLOTADOR PP ROJO

| | | | |
|----|--------------------|------------|-----------------|
| 25 | FS25D1M0150 | 15-150 | 247,22 |
| 25 | FS25D1M0250 | 25-250 | 247,22 |
| 25 | FS25D1M0450 | 45-450 | 247,22 |
| 25 | FS25D1M0700 | 70-700 | 247,22 |
| 32 | FS32D1M0250 | 25-250 | 281,77 |
| 32 | FS32D1M0400 | 40-400 | 281,77 |
| 32 | FS32D1M0650 | 65-650 | 281,77 |
| 32 | FS32D1M1000 | 100-1000 | 281,77 |
| 40 | FS40D1M1000 | 100-1000 | 379,49 |
| 40 | FS40D1M1600 | 160-1600 | 379,49 |
| 40 | FS40D1M2500 | 200-2500 | 379,49 |
| 50 | FS50D1M1600 | 150-1600 | 448,46 |
| 50 | FS50D1M2200 | 200-2200 | 448,46 |
| 50 | FS50D1M2500 | 250-2500 | 448,46 |
| 63 | FS63D1M2500 | 250-2500 | 600,85 |
| 63 | FS63D1M3500 | 350-3500 | 600,85 |
| 63 | FS63D1M5000 | 500-5000 | 600,85 |
| 75 | FS75D1M8000 | 1000-8000 | 1.043,63 |
| 75 | FS75D1M0010 | 1000-10000 | 1.043,63 |
| 75 | FS75D1M0025 | 5000-25000 | 1.043,63 |

 Flujómetro largo para **H₂O**.

 Densidad: 1 kg/l - 20° C. Cuerpo: **TROGAMID**. Juntas: **EPDM**.

FSIV
 encolar.

FLOTADOR INOX AISI 316 CON IMÁN INTERIOR incorporado para contacto exterior (suministrado aparte)

| Diámetro Encolar | Ref. Encolar | Escala l/h. | € |
|------------------|---------------------|-------------|-----------------|
| 25 | FS25D1X0250M | 25-250 | 353,65 |
| 25 | FS25D1X0400M | 40-400 | 353,65 |
| 25 | FS25D1X0640M | 60-640 | 353,65 |
| 25 | FS25D1X1000M | 100-1000 | 353,65 |
| 32 | FS32D1X0400M | 40-400 | 382,37 |
| 32 | FS32D1X0640M | 60-640 | 382,37 |
| 32 | FS32D1X1000M | 100-1000 | 382,37 |
| 32 | FS32D1X1600M | 150-1600 | 382,37 |
| 40 | FS40D1X1600M | 150-1600 | 488,75 |
| 40 | FS40D1X2500M | 200-2500 | 488,75 |
| 40 | FS40D1X4000M | 400-4000 | 488,75 |
| 50 | FS50D1X2500M | 200-2500 | 566,30 |
| 50 | FS50D1X4000M | 400-4000 | 566,30 |
| 50 | FS50D1X5000M | 500-5000 | 566,30 |
| 63 | FS63D1X4000M | 400-4000 | 735,97 |
| 63 | FS63D1X6000M | 600-6000 | 735,97 |
| 63 | FS63D1X0010M | 1000-10000 | 735,97 |
| 75 | FS75D1X0015M | 1500-15000 | 1.331,07 |
| 75 | FS75D1X0020M | 2000-20000 | 1.331,07 |
| 75 | FS75D1X0050M | 10000-50000 | 1.331,07 |

FLOTADOR PP ROJO CON IMÁN INTERIOR incorporado para contacto exterior (suministrado aparte)

| | | | |
|----|---------------------|------------|-----------------|
| 25 | FS25D1M0150M | 15-150 | 353,65 |
| 25 | FS25D1M0250M | 25-250 | 353,65 |
| 25 | FS25D1M0450M | 45-450 | 353,65 |
| 25 | FS25D1M0700M | 70-700 | 353,65 |
| 32 | FS32D1M0250M | 25-250 | 382,37 |
| 32 | FS32D1M0400M | 40-400 | 382,37 |
| 32 | FS32D1M0650M | 65-650 | 382,37 |
| 32 | FS32D1M1000M | 100-1000 | 382,37 |
| 40 | FS40D1M1000M | 100-1000 | 488,75 |
| 40 | FS40D1M1600M | 160-1600 | 488,75 |
| 40 | FS40D1M2500M | 200-2500 | 488,75 |
| 50 | FS50D1M1600M | 150-1600 | 566,30 |
| 50 | FS50D1M2200M | 200-2200 | 566,30 |
| 50 | FS50D1M2500M | 250-2500 | 566,30 |
| 63 | FS63D1M2500M | 250-2500 | 735,97 |
| 63 | FS63D1M3500M | 350-3500 | 735,97 |
| 63 | FS63D1M5000M | 500-5000 | 735,97 |
| 75 | FS75D1M8000M | 1000-8000 | 1.331,07 |
| 75 | FS75D1M0010M | 1000-10000 | 1.331,07 |
| 75 | FS75D1M0025M | 5000-25000 | 1.331,07 |

 Flujómetro largo para **H₂O**.

 Densidad: 1 kg/l - 20° C. Cuerpo: **TROGAMID**. Juntas: **EPDM**.

FSIV
 encolar.

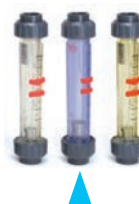
FLOTADOR INOX AISI 316

| Diámetro Encolar | Ref. Encolar | Escala l/h. | € |
|------------------|--------------------|-------------|---------------|
| 25 | FS25T1X0250 | 25-250 | 235,73 |
| 25 | FS25T1X0400 | 40-400 | 235,73 |
| 25 | FS25T1X0640 | 60-640 | 235,73 |
| 25 | FS25T1X1000 | 100-1000 | 235,73 |
| 32 | FS32T1X0400 | 40-400 | 267,37 |
| 32 | FS32T1X0640 | 60-640 | 267,37 |
| 32 | FS32T1X1000 | 100-1000 | 267,37 |
| 32 | FS32T1X1600 | 150-1600 | 267,37 |
| 40 | FS40T1X1600 | 150-1600 | 362,20 |
| 40 | FS40T1X2500 | 200-2500 | 362,20 |
| 40 | FS40T1X4000 | 400-4000 | 362,20 |
| 50 | FS50T1X2500 | 200-2500 | 425,48 |
| 50 | FS50T1X4000 | 400-4000 | 425,48 |
| 50 | FS50T1X5000 | 500-5000 | 425,48 |
| 63 | FS63T1X4000 | 400-4000 | 569,23 |
| 63 | FS63T1X6000 | 600-6000 | 569,23 |
| 63 | FS63T1X0010 | 1000-10000 | 569,23 |
| 75 | FS75T1X0015 | 1500-15000 | 991,82 |
| 75 | FS75T1X0020 | 2000-20000 | 991,82 |
| 75 | FS75T1X0050 | 10000-50000 | 991,82 |

FLOTADOR PP ROJO

| | | | |
|----|--------------------|------------|---------------|
| 25 | FS25T1M0150 | 15-150 | 235,73 |
| 25 | FS25T1M0250 | 25-250 | 235,73 |
| 25 | FS25T1M0450 | 45-450 | 235,73 |
| 25 | FS25T1M0700 | 70-700 | 235,73 |
| 32 | FS32T1M0250 | 25-250 | 267,37 |
| 32 | FS32T1M0400 | 40-400 | 267,37 |
| 32 | FS32T1M0650 | 65-650 | 267,37 |
| 32 | FS32T1M1000 | 100-1000 | 267,37 |
| 40 | FS40T1M1000 | 100-1000 | 362,20 |
| 40 | FS40T1M1600 | 160-1600 | 362,20 |
| 40 | FS40T1M2500 | 200-2500 | 362,20 |
| 50 | FS50T1M1600 | 150-1600 | 425,48 |
| 50 | FS50T1M2200 | 200-2200 | 425,48 |
| 50 | FS50T1M2500 | 250-2500 | 425,48 |
| 63 | FS63T1M2500 | 250-2500 | 569,23 |
| 63 | FS63T1M3500 | 350-3500 | 569,23 |
| 63 | FS63T1M5000 | 500-5000 | 569,23 |
| 75 | FS75T1M8000 | 1000-8000 | 991,82 |
| 75 | FS75T1M0010 | 1000-10000 | 991,82 |
| 75 | FS75T1M0025 | 5000-25000 | 991,82 |

 Flujómetro largo para H₂O.

 Densidad: 1 kg/l - 20° C. Cuerpo: **PVC Transparente** Juntas: **EPDM**.

FSIV
 encolar.



FLOTADOR INOX AISI 316 CON IMÁN INTERIOR incorporado para contacto exterior (suministrado aparte) ▲

| Diámetro Encolar | Ref. Encolar | Escala l/h. | € |
|------------------|---------------------|-------------|-----------------|
| 25 | FS25T1X0250M | 25-250 | 342,10 |
| 25 | FS25T1X0400M | 40-400 | 342,10 |
| 25 | FS25T1X0640M | 60-640 | 342,10 |
| 25 | FS25T1X1000M | 100-1000 | 342,10 |
| 32 | FS32T1X0400M | 40-400 | 368,00 |
| 32 | FS32T1X0640M | 60-640 | 368,00 |
| 32 | FS32T1X1000M | 100-1000 | 368,00 |
| 32 | FS32T1X1600M | 150-1600 | 368,00 |
| 40 | FS40T1X1600M | 150-1600 | 471,50 |
| 40 | FS40T1X2500M | 200-2500 | 471,50 |
| 40 | FS40T1X4000M | 400-4000 | 471,50 |
| 50 | FS50T1X2500M | 200-2500 | 543,39 |
| 50 | FS50T1X4000M | 400-4000 | 543,39 |
| 50 | FS50T1X5000M | 500-5000 | 543,39 |
| 63 | FS63T1X4000M | 400-4000 | 704,36 |
| 63 | FS63T1X6000M | 600-6000 | 704,36 |
| 63 | FS63T1X0010M | 1000-10000 | 704,36 |
| 75 | FS75T1X0015M | 1500-15000 | 1.279,35 |
| 75 | FS75T1X0020M | 2000-20000 | 1.279,35 |
| 75 | FS75T1X0020M | 10000-50000 | 1.279,35 |

FLOTADOR PP ROJO CON IMÁN INTERIOR incorporado para contacto exterior (suministrado aparte)

| | | | |
|----|---------------------|------------|-----------------|
| 25 | FS25T1M0150M | 15-150 | 342,10 |
| 25 | FS25T1M0250M | 25-250 | 342,10 |
| 25 | FS25T1M0450M | 45-450 | 342,10 |
| 25 | FS25T1M0700M | 70-700 | 342,10 |
| 32 | FS32T1M0250M | 25-250 | 368,00 |
| 32 | FS32T1M0400M | 40-400 | 368,00 |
| 32 | FS32T1M0650M | 65-650 | 368,00 |
| 32 | FS32T1M1000M | 100-1000 | 368,00 |
| 40 | FS40T1M1000M | 100-1000 | 471,50 |
| 40 | FS40T1M1600M | 160-1600 | 471,50 |
| 40 | FS40T1M2500M | 200-2500 | 471,50 |
| 50 | FS50T1M1600M | 150-1600 | 543,39 |
| 50 | FS50T1M2200M | 200-2200 | 543,39 |
| 50 | FS50T1M2500M | 250-2500 | 543,39 |
| 63 | FS63T1M2500M | 250-2500 | 704,36 |
| 63 | FS63T1M3500M | 350-3500 | 704,36 |
| 63 | FS63T1M5000M | 500-5000 | 704,36 |
| 75 | FS75T1M8000M | 1000-8000 | 1.279,35 |
| 75 | FS75T1M0010M | 1000-10000 | 1.279,35 |
| 75 | FS75T1M0025M | 5000-25000 | 1.279,35 |

Flujómetro largo para **H₂O**.

Densidad: 1 kg/l - 20° C. Cuerpo: **PVC Transparente** Juntas: **EPDM**.

FSIV
 encolar.

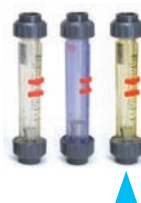

FLOTADOR INOX AISI 316

| Díametro Encolar | Ref. Encolar | Escala l/h. | € |
|------------------|--------------------|-------------|-----------------|
| 25 | FS25P1X0250 | 25-250 | 307,61 |
| 25 | FS25P1X0400 | 40-400 | 307,61 |
| 25 | FS25P1X0640 | 60-640 | 307,61 |
| 25 | FS25P1X1000 | 100-1000 | 307,61 |
| 32 | FS32P1X0400 | 40-400 | 353,65 |
| 32 | FS32P1X0640 | 60-640 | 353,65 |
| 32 | FS32P1X1000 | 100-1000 | 353,65 |
| 32 | FS32P1X1600 | 150-1600 | 353,65 |
| 40 | FS40P1X1600 | 150-1600 | 457,16 |
| 40 | FS40P1X2500 | 200-2500 | 457,16 |
| 40 | FS40P1X4000 | 400-4000 | 457,16 |
| 50 | FS50P1X2500 | 200-2500 | 560,61 |
| 50 | FS50P1X4000 | 400-4000 | 560,61 |
| 50 | FS50P1X5000 | 500-5000 | 560,61 |
| 63 | FS63P1X4000 | 400-4000 | 750,34 |
| 63 | FS63P1X6000 | 600-6000 | 750,34 |
| 63 | FS63P1X0010 | 1000-10000 | 750,34 |
| 75 | FS75P1X0015 | 1500-15000 | 1.305,23 |
| 75 | FS75P1X0020 | 2000-20000 | 1.305,23 |
| 75 | FS75P1X0050 | 10000-50000 | 1.305,23 |

FLOTADOR PP ROJO

| | | | |
|----|--------------------|------------|-----------------|
| 25 | FS25P1M0150 | 15-150 | 307,61 |
| 25 | FS25P1M0250 | 25-250 | 307,61 |
| 25 | FS25P1M0450 | 45-450 | 307,61 |
| 25 | FS25P1M0700 | 70-700 | 307,61 |
| 32 | FS32P1M0250 | 25-250 | 353,65 |
| 32 | FS32P1M0400 | 40-400 | 353,65 |
| 32 | FS32P1M0650 | 65-650 | 353,65 |
| 32 | FS32P1M1000 | 100-1000 | 353,65 |
| 40 | FS40P1M1000 | 100-1000 | 457,16 |
| 40 | FS40P1M1600 | 160-1600 | 457,16 |
| 40 | FS40P1M2500 | 200-2500 | 457,16 |
| 50 | FS50P1M1600 | 150-1600 | 560,61 |
| 50 | FS50P1M2200 | 200-2200 | 560,61 |
| 50 | FS50P1M2500 | 250-2500 | 560,61 |
| 63 | FS63P1M2500 | 250-2500 | 750,34 |
| 63 | FS63P1M3500 | 350-3500 | 750,34 |
| 63 | FS63P1M5000 | 500-5000 | 750,34 |
| 75 | FS75P1M8000 | 1000-8000 | 1.305,23 |
| 75 | FS75P1M0010 | 1000-10000 | 1.305,23 |
| 75 | FS75P1M0025 | 5000-25000 | 1.305,23 |

Flujómetro largo para **H₂O**.

Densidad: 1 kg/l - 20° C. Cuerpo: **POLYSULFON**. Juntas: **EPDM**.

FSIV
 encolar.



FLOTADOR INOX AISI 316 CON IMÁN INTERIOR incorporado para contacto exterior (suministrado aparte)

| Diámetro Encolar | Ref. Encolar | Escala l/h. | € |
|------------------|---------------------|-------------|-----------------|
| 25 | FS25P1X0250M | 25-250 | 413,99 |
| 25 | FS25P1X0400M | 40-400 | 413,99 |
| 25 | FS25P1X0640M | 60-640 | 413,99 |
| 25 | FS25P1X1000M | 100-1000 | 413,99 |
| 32 | FS32P1X0400M | 40-400 | 454,23 |
| 32 | FS32P1X0640M | 60-640 | 454,23 |
| 32 | FS32P1X1000M | 100-1000 | 454,23 |
| 32 | FS32P1X1600M | 150-1600 | 454,23 |
| 40 | FS40P1X1600M | 150-1600 | 566,30 |
| 40 | FS40P1X2500M | 200-2500 | 566,30 |
| 40 | FS40P1X4000M | 400-4000 | 566,30 |
| 50 | FS50P1X2500M | 200-2500 | 678,46 |
| 50 | FS50P1X4000M | 400-4000 | 678,46 |
| 50 | FS50P1X5000M | 500-5000 | 678,46 |
| 63 | FS63P1X4000M | 400-4000 | 885,46 |
| 63 | FS63P1X6000M | 600-6000 | 885,46 |
| 63 | FS63P1X0010M | 1000-10000 | 885,46 |
| 75 | FS75P1X0015M | 1500-15000 | 1.592,72 |
| 75 | FS75P1X0020M | 2000-20000 | 1.592,72 |
| 75 | FS75P1X0050M | 10000-50000 | 1.592,72 |

FLOTADOR PP ROJO CON IMÁN INTERIOR incorporado para contacto exterior (suministrado aparte)

| | | | |
|----|---------------------|------------|-----------------|
| 25 | FS25P1M0150M | 15-150 | 413,99 |
| 25 | FS25P1M0250M | 25-250 | 413,99 |
| 25 | FS25P1M0450M | 45-450 | 413,99 |
| 25 | FS25P1M0700M | 70-700 | 413,99 |
| 32 | FS32P1M0250M | 25-250 | 454,23 |
| 32 | FS32P1M0400M | 40-400 | 454,23 |
| 32 | FS32P1M0650M | 65-650 | 454,23 |
| 32 | FS32P1M1000M | 100-1000 | 454,23 |
| 40 | FS40P1M1000M | 100-1000 | 566,30 |
| 40 | FS40P1M1600M | 160-1600 | 566,30 |
| 40 | FS40P1M2500M | 200-2500 | 566,30 |
| 50 | FS50P1M1600M | 150-1600 | 678,46 |
| 50 | FS50P1M2200M | 200-2200 | 678,46 |
| 50 | FS50P1M2500M | 250-2500 | 678,46 |
| 63 | FS63P1M2500M | 250-2500 | 885,46 |
| 63 | FS63P1M3500M | 350-3500 | 885,46 |
| 63 | FS63P1M5000M | 500-5000 | 885,46 |
| 75 | FS75P1M8000M | 1000-8000 | 1.592,72 |
| 75 | FS75P1M0010M | 1000-10000 | 1.592,72 |
| 75 | FS75P1M0025M | 5000-25000 | 1.592,72 |

Flujómetro largo para **H₂O**.

Densidad: 1 kg/l - 20° C. Cuerpo: **POLYSULFON**. Juntas: **EPDM**.

FSIV
 encolar.

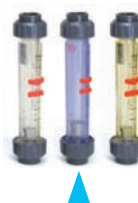

FLOTADOR INOX AISI 316

| Diámetro Encolar | Ref. Encolar | Escala l/h. | € |
|------------------|--------------|-------------|----------|
| 25 | FS25T3X0125 | 6-125 | 267,82 |
| 25 | FS25T3X0240 | 10-240 | 267,82 |
| 25 | FS25T3X0425 | 25-425 | 267,82 |
| 25 | FS25T3X0725 | 35-725 | 267,82 |
| 32 | FS32T3X0240 | 10-240 | 303,83 |
| 32 | FS32T3X0420 | 20-420 | 303,83 |
| 32 | FS32T3X0700 | 25-700 | 303,83 |
| 32 | FS32T3X1200 | 50-1200 | 303,83 |
| 40 | FS40T3X1150 | 50-1150 | 411,57 |
| 40 | FS40T3X1900 | 100-1900 | 411,57 |
| 40 | FS40T3X3200 | 200-3200 | 411,57 |
| 50 | FS50T3X1700 | 100-1700 | 483,48 |
| 50 | FS50T3X3000 | 200-3000 | 483,48 |
| 50 | FS50T3X3700 | 200-3700 | 483,48 |
| 63 | FS63T3X3000 | 100-3000 | 646,84 |
| 63 | FS63T3X4700 | 250-4700 | 646,84 |
| 63 | FS63T3X8500 | 500-8500 | 646,84 |
| 75 | FS75T3X0012 | 1000-12000 | 1.127,02 |
| 75 | FS75T3X0165 | 1500-16500 | 1.127,02 |
| 75 | FS75T3X0043 | 8800-43000 | 1.127,02 |

FLOTADOR PP ROJO

| | | | |
|----|-------------|------------|----------|
| 25 | FS25T3M0054 | 2,5-54 | 267,82 |
| 25 | FS25T3M0115 | 6-115 | 267,82 |
| 25 | FS25T3M0235 | 11-235 | 267,82 |
| 25 | FS25T3M0410 | 28-410 | 267,82 |
| 32 | FS32T3M0125 | 6-125 | 303,83 |
| 32 | FS32T3M0100 | 10-100 | 303,83 |
| 32 | FS32T3M0395 | 11-395 | 303,83 |
| 32 | FS32T3M0650 | 25-650 | 303,83 |
| 40 | FS40T3M0600 | 25-600 | 664,95 |
| 40 | FS40T3M1100 | 55-1100 | 411,57 |
| 40 | FS40T3M1700 | 100-1700 | 411,57 |
| 50 | FS50T3M1000 | 50-1000 | 483,48 |
| 50 | FS50T3M1500 | 100-1500 | 483,48 |
| 50 | FS50T3M1600 | 120-1600 | 483,48 |
| 63 | FS63T3M1700 | 60-1700 | 646,84 |
| 63 | FS63T3M2500 | 90-2500 | 646,84 |
| 63 | FS63T3M4000 | 200-4000 | 646,84 |
| 75 | FS75T3M6000 | 670-6000 | 1.127,02 |
| 75 | FS75T3M7500 | 500-7500 | 1.127,02 |
| 75 | FS75T3M0022 | 4400-22000 | 1.127,02 |

Flujómetro largo para **Hidróxido de sodio (NaOH) 30%..**

Densidad: 1,33 kg/l - 20° C. Cuerpo **PVC Transparente**. Juntas: **EPDM**.

FSIV
 encolar.

FLOTADOR INOX AISI 316 CON IMÁN INTERIOR incorporado para contacto exterior (suministrado aparte)

| Diámetro Encolar | Ref. Encolar | Escala l/h. | € |
|------------------|---------------------|-------------|-----------------|
| 25 | FS25T3X0125M | 6-125 | 388,76 |
| 25 | FS25T3X0240M | 10-240 | 388,76 |
| 25 | FS25T3X0425M | 25-425 | 388,76 |
| 25 | FS25T3X0725M | 35-725 | 388,76 |
| 32 | FS32T3X0240M | 10-240 | 418,13 |
| 32 | FS32T3X0420M | 20-420 | 418,13 |
| 32 | FS32T3X0700M | 25-700 | 418,13 |
| 32 | FS32T3X1200M | 50-1200 | 418,13 |
| 40 | FS40T3X1150M | 50-1150 | 535,76 |
| 40 | FS40T3X1900M | 100-1900 | 535,76 |
| 40 | FS40T3X3200M | 200-3200 | 535,76 |
| 50 | FS50T3X1700M | 100-1700 | 617,45 |
| 50 | FS50T3X3000M | 200-3000 | 617,45 |
| 50 | FS50T3X3700M | 200-3700 | 617,45 |
| 63 | FS63T3X3000M | 100-3000 | 800,38 |
| 63 | FS63T3X4700M | 250-4700 | 800,38 |
| 63 | FS63T3X8500M | 500-8500 | 800,38 |
| 75 | FS75T3X0012M | 1000-12000 | 1.453,71 |
| 75 | FS75T3X0165M | 1500-16500 | 1.453,71 |
| 75 | FS75T3X0043M | 8800-43000 | 1.453,71 |

FLOTADOR PP ROJO CON IMÁN INTERIOR incorporado para contacto exterior (suministrado aparte)

| | | | |
|----|---------------------|------------|-----------------|
| 25 | FS25T3M0054M | 2,5-54 | 388,76 |
| 25 | FS25T3M0115M | 6-115 | 388,76 |
| 25 | FS25T3M0235M | 11-235 | 388,76 |
| 25 | FS25T3M0410M | 28-410 | 388,76 |
| 32 | FS32T3M0125M | 6-125 | 418,13 |
| 32 | FS32T3M0100M | 10-100 | 418,13 |
| 32 | FS32T3M0395M | 11-395 | 418,13 |
| 32 | FS32T3M0650M | 25-650 | 418,13 |
| 40 | FS40T3M0600M | 25-600 | 535,76 |
| 40 | FS40T3M1100M | 55-1100 | 535,76 |
| 40 | FS40T3M1700M | 100-1700 | 535,76 |
| 50 | FS50T3M1000M | 50-1000 | 617,45 |
| 50 | FS50T3M1500M | 100-1500 | 617,45 |
| 50 | FS50T3M1600M | 120-1600 | 617,45 |
| 63 | FS63T3M1700M | 60-1700 | 800,38 |
| 63 | FS63T3M2500M | 90-2500 | 800,38 |
| 63 | FS63T3M4000M | 200-4000 | 800,38 |
| 75 | FS75T3M6000M | 670-6000 | 1.453,71 |
| 75 | FS75T3M7500M | 500-7500 | 1.453,71 |
| 75 | FS75T3M0022M | 4400-22000 | 1.453,71 |

 Flujómetro largo para **Hidróxido de sodio (NaOH) 30%..**

 Densidad: 1,33 kg/l - 20° C. Cuerpo **PVC Transparente**. Juntas: **EPDM**.

FSIV
 encolar.

FLOTADOR INOX AISI 316

| Diámetro Encolar | Ref. Encolar | Escala l/h. | € |
|------------------|--------------|-------------|----------|
| 25 | FS25P3X0125 | 6-125 | 349,53 |
| 25 | FS25P3X0240 | 10-240 | 349,53 |
| 25 | FS25P3X0425 | 25-425 | 349,53 |
| 25 | FS25P3X0725 | 35-725 | 349,53 |
| 32 | FS32P3X0240 | 10-240 | 401,79 |
| 32 | FS32P3X0420 | 20-420 | 401,79 |
| 32 | FS32P3X0700 | 25-700 | 401,79 |
| 32 | FS32P3X1200 | 50-1200 | 401,79 |
| 40 | FS40P3X1150 | 50-1150 | 519,48 |
| 40 | FS40P3X1900 | 100-1900 | 519,48 |
| 40 | FS40P3X3200 | 200-3200 | 519,48 |
| 50 | FS50P3X1700 | 100-1700 | 637,02 |
| 50 | FS50P3X3000 | 200-3000 | 637,02 |
| 50 | FS50P3X3700 | 200-3700 | 637,02 |
| 63 | FS63P3X3000 | 100-3000 | 852,60 |
| 63 | FS63P3X4700 | 250-4700 | 852,60 |
| 63 | FS63P3X8500 | 500-8500 | 852,60 |
| 75 | FS75P3X0012 | 1000-12000 | 1.483,13 |
| 75 | FS75P3X0165 | 1500-16500 | 1.483,13 |
| 75 | FS75P3X0043 | 8800-43000 | 1.483,13 |

FLOTADOR PP ROJO

| | | | |
|----|-------------|------------|----------|
| 25 | FS25P3M0054 | 2,5-54 | 349,53 |
| 25 | FS25P3M0115 | 6-115 | 349,53 |
| 25 | FS25P3M0235 | 11-235 | 349,53 |
| 25 | FS25P3M0410 | 28-410 | 349,53 |
| 32 | FS32P3M0125 | 6-125 | 401,79 |
| 32 | FS32P3M0100 | 10-100 | 401,79 |
| 32 | FS32P3M0395 | 11-395 | 401,79 |
| 32 | FS32P3M0650 | 25-650 | 401,79 |
| 40 | FS40P3M0600 | 25-600 | 519,48 |
| 40 | FS40P3M1100 | 55-1100 | 519,48 |
| 40 | FS40P3M1700 | 100-1700 | 519,48 |
| 50 | FS50P3M1000 | 50-1000 | 637,02 |
| 50 | FS50P3M1500 | 100-1500 | 637,02 |
| 50 | FS50P3M1600 | 120-1600 | 637,02 |
| 63 | FS63P3M1700 | 60-1700 | 852,60 |
| 63 | FS63P3M2500 | 90-2500 | 852,60 |
| 63 | FS63P3M4000 | 200-4000 | 852,60 |
| 75 | FS75P3M6000 | 670-6000 | 1.483,13 |
| 75 | FS75P3M7500 | 500-7500 | 1.483,13 |
| 75 | FS75P3M0022 | 4400-22000 | 1.483,13 |

 Flujómetro largo para **Hidróxido de sodio (NaOH) 30%..**

 Densidad: 1,33 kg/l 20° C. Cuerpo: **POLYSULFON**. Juntas: **EPDM**.

FSIV
 encolar.



FLOTADOR INOX AISI 316 CON IMÁN INTERIOR incorporado para contacto exterior (suministrado aparte)

| Diámetro Encolar | Ref. Encolar | Escala l/h. | € |
|------------------|---------------------|-------------|-----------------|
| 25 | FS25P3X0125M | 6-125 | 470,44 |
| 25 | FS25P3X0240M | 10-240 | 470,44 |
| 25 | FS25P3X0425M | 25-425 | 470,44 |
| 25 | FS25P3X0725M | 35-725 | 470,44 |
| 32 | FS32P3X0240M | 10-240 | 516,12 |
| 32 | FS32P3X0420M | 20-420 | 516,12 |
| 32 | FS32P3X0700M | 25-700 | 516,12 |
| 32 | FS32P3X1200M | 50-1200 | 516,12 |
| 40 | FS40P3X1150M | 50-1150 | 643,51 |
| 40 | FS40P3X1900M | 100-1900 | 643,51 |
| 40 | FS40P3X3200M | 200-3200 | 643,51 |
| 50 | FS50P3X1700M | 100-1700 | 770,97 |
| 50 | FS50P3X3000M | 200-3000 | 770,97 |
| 50 | FS50P3X3700M | 200-3700 | 770,97 |
| 63 | FS63P3X3000M | 100-3000 | 1.006,19 |
| 63 | FS63P3X4700M | 250-4700 | 1.006,19 |
| 63 | FS63P3X8500M | 500-8500 | 1.006,19 |
| 75 | FS75P3X0012M | 1000-12000 | 1.809,83 |
| 75 | FS75P3X0165M | 1500-16500 | 1.809,83 |
| 75 | FS75P3X0043M | 8800-43000 | 1.809,83 |

FLOTADOR PP ROJO CON IMÁN INTERIOR incorporado para contacto exterior (suministrado aparte)

| | | | |
|----|---------------------|------------|-----------------|
| 25 | FS25P3M0054M | 2,5-54 | 470,44 |
| 25 | FS25P3M0115M | 6-115 | 470,44 |
| 25 | FS25P3M0235M | 11-235 | 470,44 |
| 25 | FS25P3M0410M | 28-410 | 470,44 |
| 32 | FS32P3M0125M | 6-125 | 516,12 |
| 32 | FS32P3M0100M | 10-100 | 516,12 |
| 32 | FS32P3M0395M | 11-395 | 516,12 |
| 32 | FS32P3M0650M | 25-650 | 516,12 |
| 40 | FS40P3M0600M | 25-600 | 643,51 |
| 40 | FS40P3M1100M | 55-1100 | 643,51 |
| 40 | FS40P3M1700M | 100-1700 | 643,51 |
| 50 | FS50P3M1000M | 50-1000 | 770,97 |
| 50 | FS50P3M1500M | 100-1500 | 770,97 |
| 50 | FS50P3M1600M | 120-1600 | 770,97 |
| 63 | FS63P3M1700M | 60-1700 | 1.006,19 |
| 63 | FS63P3M2500M | 90-2500 | 1.006,19 |
| 63 | FS63P3M4000M | 200-4000 | 1.006,19 |
| 75 | FS75P3M6000M | 670-6000 | 1.809,83 |
| 75 | FS75P3M7500M | 500-7500 | 1.809,83 |
| 75 | FS75P3M0022M | 4400-22000 | 1.809,83 |

Flujómetro largo para **Hidróxido de sodio (NaOH) 30%..**

Densidad: 1,33 kg/l 20° C. Cuerpo: **POLYSULFON**. Juntas: **EPDM**.

FSIV
 encolar.

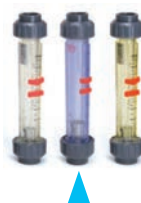

FLOTADOR INOX AISI 316

| Diámetro Encolar | Ref. Encolar | Escala l/h. | € |
|------------------|--------------------|-------------|-----------------|
| 25 | FS25T5X0027 | 1-27 | 267,82 |
| 25 | FS25T5X0070 | 2,5-70 | 267,82 |
| 25 | FS25T5X0170 | 5-170 | 267,82 |
| 25 | FS25T5X0350 | 15-350 | 267,82 |
| 32 | FS32T5X0065 | 2,5-65 | 303,83 |
| 32 | FS32T5X0145 | 5-145 | 303,83 |
| 32 | FS32T5X0330 | 10-330 | 303,83 |
| 32 | FS32T5X0675 | 25-675 | 303,83 |
| 40 | FS40T5X0550 | 25-550 | 411,57 |
| 40 | FS40T5X1100 | 50-1100 | 411,57 |
| 40 | FS40T5X2000 | 100-2000 | 411,57 |
| 50 | FS50T5X1000 | 50-1000 | 483,48 |
| 50 | FS50T5X1900 | 50-1900 | 483,48 |
| 50 | FS50T5X2500 | 100-2500 | 483,48 |
| 63 | FS63T5X1800 | 50-1800 | 646,84 |
| 63 | FS63T5X3100 | 100-3100 | 646,84 |
| 63 | FS63T5X6000 | 250-6000 | 646,84 |
| 75 | FS75T5X9000 | 250-9000 | 1.127,02 |
| 75 | FS75T5X0125 | 500-12500 | 1.127,02 |
| 75 | FS75T5X0040 | 8200-40000 | 1.127,02 |

FLOTADOR PP ROJO

| | | | |
|----|--------------------|------------|-----------------|
| 25 | FS25T5M0095 | 0,5-9,5 | 267,82 |
| 25 | FS25T5M0023 | 1,5-23 | 267,82 |
| 25 | FS25T5M0065 | 3-65 | 267,82 |
| 25 | FS25T5M0145 | 7-145 | 267,82 |
| 32 | FS32T5M0020 | 1-20 | 303,83 |
| 32 | FS32T5M0050 | 2,5-50 | 303,83 |
| 32 | FS32T5M0130 | 5,5-130 | 303,83 |
| 32 | FS32T5M0260 | 10-260 | 303,83 |
| 40 | FS40T5M0200 | 10-200 | 411,57 |
| 40 | FS40T5M0500 | 20-500 | 411,57 |
| 40 | FS40T5M0950 | 25-950 | 411,57 |
| 50 | FS50T5M0425 | 25-425 | 483,48 |
| 50 | FS50T5M0800 | 25-800 | 483,48 |
| 50 | FS50T5M0950 | 40-950 | 483,48 |
| 63 | FS63T5M0800 | 30-800 | 646,84 |
| 63 | FS63T5M1400 | 40-1400 | 646,84 |
| 63 | FS63T5M2500 | 80-2500 | 646,84 |
| 75 | FS75T5M3800 | 330-3800 | 1.127,02 |
| 75 | FS75T5M5200 | 170-5200 | 1.127,02 |
| 75 | FS75T5M0020 | 4100-20000 | 1.127,02 |

Flujómetro largo para **Hidróxido de sodio (NaOH) 50%..**

Densidad: 1,53 kg/l - 20° C. Cuerpo **PVC Transparente**. Juntas: **EPDM**.

FSIV
 encolar.



FLOTADOR INOX AISI 316 CON IMÁN INTERIOR incorporado para contacto exterior (suministrado aparte) ▲

| Diámetro Encolar | Ref. Encolar | Escala l/h. | € |
|------------------|---------------------|-------------|-----------------|
| 25 | FS25T5X0027M | 1-27 | 388,76 |
| 25 | FS25T5X0070M | 2,5-70 | 388,76 |
| 25 | FS25T5X0170M | 5-170 | 388,76 |
| 25 | FS25T5X0350M | 15-350 | 388,76 |
| 32 | FS32T5X0065M | 2,5-65 | 418,13 |
| 32 | FS32T5X0145M | 5-145 | 418,13 |
| 32 | FS32T5X0330M | 10-330 | 418,13 |
| 32 | FS32T5X0675M | 25-675 | 418,13 |
| 40 | FS40T5X0550M | 25-550 | 535,76 |
| 40 | FS40T5X1100M | 50-1100 | 535,76 |
| 40 | FS40T5X2000M | 100-2000 | 535,76 |
| 50 | FS50T5X1000M | 50-1000 | 617,45 |
| 50 | FS50T5X1900M | 50-1900 | 617,45 |
| 50 | FS50T5X2500M | 100-2500 | 617,45 |
| 63 | FS63T5X1800M | 50-1800 | 800,38 |
| 63 | FS63T5X3100M | 100-3100 | 800,38 |
| 63 | FS63T5X6000M | 250-6000 | 800,38 |
| 75 | FS75T5X9000M | 250-9000 | 1.453,71 |
| 75 | FS75T5X0125M | 500-12500 | 1.453,71 |
| 75 | FS75T5X0040M | 8200-40000 | 1.453,71 |

FLOTADOR PP ROJO CON IMÁN INTERIOR incorporado para contacto exterior (suministrado aparte)

| | | | |
|----|---------------------|------------|-----------------|
| 25 | FS25T5M0095M | 0,5-9,5 | 388,76 |
| 25 | FS25T5M0023M | 1,5-23 | 388,76 |
| 25 | FS25T5M0065M | 3-65 | 388,76 |
| 25 | FS25T5M0145M | 7-145 | 388,76 |
| 32 | FS32T5M0020M | 1-20 | 418,13 |
| 32 | FS32T5M0050M | 2,5-50 | 418,13 |
| 32 | FS32T5M0130M | 5,5-130 | 418,13 |
| 32 | FS32T5M0260M | 10-260 | 418,13 |
| 40 | FS40T5M0200M | 10-200 | 535,76 |
| 40 | FS40T5M0500M | 20-500 | 535,76 |
| 40 | FS40T5M0950M | 25-950 | 535,76 |
| 50 | FS50T5M0425M | 25-425 | 617,45 |
| 50 | FS50T5M0800M | 25-800 | 617,45 |
| 50 | FS50T5M0950M | 40-950 | 617,45 |
| 63 | FS63T5M0800M | 30-800 | 800,38 |
| 63 | FS63T5M1400M | 40-1400 | 800,38 |
| 63 | FS63T5M2500M | 80-2500 | 800,38 |
| 75 | FS75T5M3800M | 330-3800 | 1.453,71 |
| 75 | FS75T5M5200M | 170-5200 | 1.453,71 |
| 75 | FS75T5M0020M | 4100-20000 | 1.453,71 |

Flujómetro largo para **Hidróxido de sodio (NaOH) 50%..**

Densidad: 1,53 kg/l - 20° C. Cuerpo **PVC Transparente**. Juntas: **EPDM**.

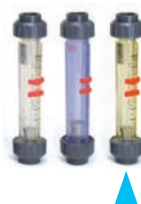
FSIV
 encolar.

FLOTADOR INOX AISI 316

| Diámetro Encolar | Ref. Encolar | Escala l/h. | € |
|------------------|--------------------|-------------|-----------------|
| 25 | FS25P5X0027 | 1-27 | 349,53 |
| 25 | FS25P5X0070 | 2,5-70 | 349,53 |
| 25 | FS25P5X0170 | 5-170 | 349,53 |
| 25 | FS25P5X0350 | 15-350 | 349,53 |
| 32 | FS32P5X0065 | 2,5-65 | 401,79 |
| 32 | FS32P5X0145 | 5-145 | 401,79 |
| 32 | FS32P5X0330 | 10-330 | 401,79 |
| 32 | FS32P5X0675 | 25-675 | 401,79 |
| 40 | FS40P5X0550 | 25-550 | 519,48 |
| 40 | FS40P5X1100 | 50-1100 | 519,48 |
| 40 | FS40P5X2000 | 100-2000 | 519,48 |
| 50 | FS50P5X1000 | 50-1000 | 637,02 |
| 50 | FS50P5X1900 | 50-1900 | 637,02 |
| 50 | FS50P5X2500 | 100-2500 | 637,02 |
| 63 | FS63P5X1800 | 50-1800 | 852,60 |
| 63 | FS63P5X3100 | 100-3100 | 852,60 |
| 63 | FS63P5X6000 | 250-6000 | 852,60 |
| 75 | FS75P5X9000 | 250-9000 | 1.483,13 |
| 75 | FS75P5X0125 | 500-12500 | 1.483,13 |
| 75 | FS75P5X0040 | 8200-40000 | 1.483,13 |

FLOTADOR PP ROJO

| | | | |
|----|--------------------|------------|-----------------|
| 25 | FS25P5M0095 | 0,5-9,5 | 349,53 |
| 25 | FS25P5M0023 | 1,5-23 | 349,53 |
| 25 | FS25P5M0065 | 3-65 | 349,53 |
| 25 | FS25P5M0145 | 7-145 | 349,53 |
| 32 | FS32P5M0020 | 1-20 | 401,79 |
| 32 | FS32P5M0050 | 2,5-50 | 401,79 |
| 32 | FS32P5M0130 | 5,5-130 | 401,79 |
| 32 | FS32P5M0260 | 10-260 | 401,79 |
| 40 | FS40P5M0200 | 10-200 | 519,48 |
| 40 | FS40P5M0500 | 20-500 | 519,48 |
| 40 | FS40P5M0950 | 25-950 | 519,48 |
| 50 | FS50P5M0425 | 25-425 | 637,02 |
| 50 | FS50P5M0800 | 25-800 | 637,02 |
| 50 | FS50P5M0950 | 40-950 | 637,02 |
| 63 | FS63P5M0800 | 30-800 | 852,60 |
| 63 | FS63P5M1400 | 40-1400 | 852,60 |
| 63 | FS63P5M2500 | 80-2500 | 852,60 |
| 75 | FS75P5M3800 | 330-3800 | 1.483,13 |
| 75 | FS75P5M5200 | 170-5200 | 1.483,13 |
| 75 | FS75P5M0020 | 4100-20000 | 1.483,13 |

 Flujómetro largo para **Hidróxido de sodio (NaOH) 50%..**

 Densidad: 1,53 kg/l - 20° C. Cuerpo **POLYSULFON** Juntas: **EPDM**.

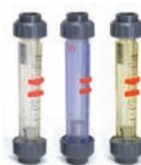
FSIV
 encolar.

FLOTADOR INOX AISI 316 CON IMÁN INTERIOR incorporado para contacto exterior (suministrado aparte)

| Diámetro Encolar | Ref. Encolar | Escala l/h. | € |
|------------------|---------------------|-------------|-----------------|
| 25 | FS25P5X0027M | 1-27 | 470,44 |
| 25 | FS25P5X0070M | 2,5-70 | 470,44 |
| 25 | FS25P5X0170M | 5-170 | 470,44 |
| 25 | FS25P5X0350M | 15-350 | 470,44 |
| 32 | FS32P5X0065M | 2,5-65 | 516,12 |
| 32 | FS32P5X0145M | 5-145 | 516,12 |
| 32 | FS32P5X0330M | 10-330 | 516,12 |
| 32 | FS32P5X0675M | 25-675 | 516,12 |
| 40 | FS40P5X0550M | 25-550 | 643,51 |
| 40 | FS40P5X1100M | 50-1100 | 643,51 |
| 40 | FS40P5X2000M | 100-2000 | 643,51 |
| 50 | FS50P5X1000M | 50-1000 | 770,97 |
| 50 | FS50P5X1900M | 50-1900 | 770,97 |
| 50 | FS50P5X2500M | 100-2500 | 770,97 |
| 63 | FS63P5X1800M | 50-1800 | 1.006,19 |
| 63 | FS63P5X3100M | 100-3100 | 1.006,19 |
| 63 | FS63P5X6000M | 250-6000 | 1.006,19 |
| 75 | FS75P5X9000M | 250-9000 | 1.809,83 |
| 75 | FS75P5X0125M | 500-12500 | 1.809,83 |
| 75 | FS75P5X0040M | 8200-40000 | 1.809,83 |

FLOTADOR PP ROJO CON IMÁN INTERIOR incorporado para contacto exterior (suministrado aparte)

| | | | |
|----|---------------------|------------|-----------------|
| 25 | FS25P5M0095M | 0,5-9,5 | 470,44 |
| 25 | FS25P5M0023M | 1,5-23 | 470,44 |
| 25 | FS25P5M0065M | 3-65 | 470,44 |
| 25 | FS25P5M0145M | 7-145 | 470,44 |
| 32 | FS32P5M0020M | 1-20 | 516,12 |
| 32 | FS32P5M0050M | 2,5-50 | 516,12 |
| 32 | FS32P5M0130M | 5,5-130 | 516,12 |
| 32 | FS32P5M0260M | 10-260 | 516,12 |
| 40 | FS40P5M0200M | 10-200 | 643,51 |
| 40 | FS40P5M0500M | 20-500 | 643,51 |
| 40 | FS40P5M0950M | 25-950 | 643,51 |
| 50 | FS50P5M0425M | 25-425 | 770,97 |
| 50 | FS50P5M0800M | 25-800 | 770,97 |
| 50 | FS50P5M0950M | 40-950 | 770,97 |
| 63 | FS63P5M0800M | 30-800 | 1.006,19 |
| 63 | FS63P5M1400M | 40-1400 | 1.006,19 |
| 63 | FS63P5M2500M | 80-2500 | 1.006,19 |
| 75 | FS75P5M3800M | 330-3800 | 1.809,83 |
| 75 | FS75P5M5200M | 170-5200 | 1.809,83 |
| 75 | FS75P5M0020M | 4100-20000 | 1.809,83 |

 Flujómetro largo para **Hidróxido de sodio (NaOH) 50%..**

 Densidad: 1,53 kg/l - 20° C. Cuerpo **POLYSULFON** Juntas: **EPDM**.

FSIV
 encolar.



FLOTADOR PP ROJO

| Diámetro Encolar | Ref. Encolar | Escala l/h. | € |
|------------------|--------------------|-------------|-----------------|
| 25 | FS25T2M0140 | 14-140 | 267,82 |
| 25 | FS25T2M0230 | 23-230 | 267,82 |
| 25 | FS25T2M0420 | 42-420 | 267,82 |
| 25 | FS25T2M0650 | 65-650 | 267,82 |
| 32 | FS32T2M0230 | 23-230 | 303,83 |
| 32 | FS32T2M0370 | 37-370 | 303,83 |
| 32 | FS32T2M0600 | 60-600 | 303,83 |
| 32 | FS32T2M0900 | 90-900 | 303,83 |
| 40 | FS40T2M0900 | 90-900 | 411,57 |
| 40 | FS40T2M1500 | 150-1500 | 411,57 |
| 40 | FS40T2M2300 | 200-2300 | 411,57 |
| 50 | FS50T2M1500 | 140-1500 | 483,48 |
| 50 | FS50T2M2000 | 190-2000 | 483,48 |
| 50 | FS50T2M2300 | 230-2300 | 483,48 |
| 63 | FS63T2M2300 | 230-2300 | 646,84 |
| 63 | FS63T2M3200 | 330-3200 | 646,84 |
| 63 | FS63T2M4600 | 470-4600 | 646,84 |
| 75 | FS75T2M7500 | 950-7500 | 1.127,02 |
| 75 | FS75T2M9300 | 930-9300 | 1.127,02 |
| 75 | FS75T2M0023 | 4700-23000 | 1.127,02 |

FLOTADOR PP ROJO CON IMÁN INTERIOR incorporado para contacto exterior (suministrado aparte)

| | | | |
|----|---------------------|------------|-----------------|
| 25 | FS25T2M0140M | 14-140 | 388,76 |
| 25 | FS25T2M0230M | 23-230 | 388,76 |
| 25 | FS25T2M0420M | 42-420 | 388,76 |
| 25 | FS25T2M0650M | 65-650 | 388,76 |
| 32 | FS32T2M0230M | 23-230 | 418,13 |
| 32 | FS32T2M0370M | 37-370 | 418,13 |
| 32 | FS32T2M0600M | 60-600 | 418,13 |
| 32 | FS32T2M0900M | 90-900 | 418,13 |
| 40 | FS40T2M0900M | 90-900 | 535,76 |
| 40 | FS40T2M1500M | 150-1500 | 535,76 |
| 40 | FS40T2M2300M | 200-2300 | 535,76 |
| 50 | FS50T2M1500M | 140-1500 | 617,45 |
| 50 | FS50T2M2000M | 190-2000 | 617,45 |
| 50 | FS50T2M2300M | 230-2300 | 617,45 |
| 63 | FS63T2M2300M | 230-2300 | 800,38 |
| 63 | FS63T2M3200M | 330-3200 | 800,38 |
| 63 | FS63T2M4600M | 470-4600 | 800,38 |
| 75 | FS75T2M7500M | 950-7500 | 1.453,71 |
| 75 | FS75T2M9300M | 930-9300 | 1.453,71 |
| 75 | FS75T2M0023M | 4700-23000 | 1.453,71 |

Flujómetro largo para **Ácido clorhídrico (HCl) 30-33%**.

Densidad: 1,16 kg/l - 20° C. Cuerpo **PVC Transparente**. Juntas: **EPDM**.

FSIV
 encolar.

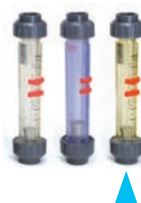

FLOTADOR PP ROJO

| Diámetro Encolar | Ref. Encolar | Escala l/h. | € |
|------------------|--------------------|-------------|-----------------|
| 25 | FS25P2M0140 | 14-140 | 349,53 |
| 25 | FS25P2M0230 | 23-230 | 349,53 |
| 25 | FS25P2M0420 | 42-420 | 349,53 |
| 25 | FS25P2M0650 | 65-650 | 349,53 |
| 32 | FS32P2M0230 | 23-230 | 401,79 |
| 32 | FS32P2M0370 | 37-370 | 401,79 |
| 32 | FS32P2M0600 | 60-600 | 401,79 |
| 32 | FS32P2M0900 | 90-900 | 401,79 |
| 40 | FS40P2M0900 | 90-900 | 519,48 |
| 40 | FS40P2M1500 | 150-1500 | 519,48 |
| 40 | FS40P2M2300 | 200-2300 | 519,48 |
| 50 | FS50P2M1500 | 140-1500 | 637,02 |
| 50 | FS50P2M2000 | 190-2000 | 637,02 |
| 50 | FS50P2M2300 | 230-2300 | 637,02 |
| 63 | FS63P2M2300 | 230-2300 | 852,60 |
| 63 | FS63P2M3200 | 330-3200 | 852,60 |
| 63 | FS63P2M4600 | 470-4600 | 852,60 |
| 75 | FS75P2M7500 | 950-7500 | 1.483,13 |
| 75 | FS75P2M9300 | 930-9300 | 1.483,13 |
| 75 | FS75P2M0023 | 4700-23000 | 1.483,13 |

FLOTADOR PP ROJO CON IMÁN INTERIOR incorporado para contacto exterior (suministrado aparte)

| | | | |
|----|---------------------|------------|-----------------|
| 25 | FS25P2M0140M | 14-140 | 470,44 |
| 25 | FS25P2M0230M | 23-230 | 470,44 |
| 25 | FS25P2M0420M | 42-420 | 470,44 |
| 25 | FS25P2M0650M | 65-650 | 470,44 |
| 32 | FS32P2M0230M | 23-230 | 516,12 |
| 32 | FS32P2M0370M | 37-370 | 516,12 |
| 32 | FS32P2M0600M | 60-600 | 516,12 |
| 32 | FS32P2M0900M | 90-900 | 516,12 |
| 40 | FS40P2M0900M | 90-900 | 643,51 |
| 40 | FS40P2M1500M | 150-1500 | 643,51 |
| 40 | FS40P2M2300M | 200-2300 | 643,51 |
| 50 | FS50P2M1500M | 140-1500 | 770,97 |
| 50 | FS50P2M2000M | 190-2000 | 770,97 |
| 50 | FS50P2M2300M | 230-2300 | 770,97 |
| 63 | FS63P2M2300M | 230-2300 | 1.006,19 |
| 63 | FS63P2M3200M | 330-3200 | 1.006,19 |
| 63 | FS63P2M4600M | 470-4600 | 1.006,19 |
| 75 | FS75P2M7500M | 950-7500 | 1.809,83 |
| 75 | FS75P2M9300M | 930-9300 | 1.809,83 |
| 75 | FS75P2M0023M | 4700-23000 | 1.809,83 |

Flujómetro largo para **Ácido clorhídrico (HCl) 30-33%**.

Densidad: 1,16 kg/l - 20° C. Cuerpo **POLYSULFON** Juntas: **EPDM**.

FSIV
 encolar.



FLOTADOR PP ROJO

| Diámetro Encolar | Ref. Encolar | Escala Nm³/h | € |
|------------------|--------------------|--------------|-----------------|
| 25 | FS25D0M0025 | 0,2-2,5 | 294,00 |
| 25 | FS25D0M0004 | 0,3-4 | 294,00 |
| 25 | FS25D0M0065 | 0,5-6,5 | 294,00 |
| 25 | FS25D0M0010 | 1-10 | 294,00 |
| 32 | FS32D0M0004 | 0,4-4 | 329,91 |
| 32 | FS32D0M0065 | 0,5-6,5 | 329,91 |
| 32 | FS32D0M0010 | 1-10 | 329,91 |
| 32 | FS32D0M0016 | 1,5-16 | 329,91 |
| 40 | FS40D0M0016 | 1,5-16 | 441,00 |
| 40 | FS40D0M0025 | 2-25 | 441,00 |
| 40 | FS40D0M0040 | 4-40 | 441,00 |
| 50 | FS50D0M0025 | 2-25 | 512,89 |
| 50 | FS50D0M0040 | 4-40 | 512,89 |
| 50 | FS50D0M0050 | 5-50 | 512,89 |
| 63 | FS63D0M0040 | 4-40 | 669,62 |
| 63 | FS63D0M0064 | 6-64 | 669,62 |
| 63 | FS63D0M0100 | 10-100 | 669,62 |
| 75 | FS75D0M0140 | 15-140 | 1.146,63 |
| 75 | FS75D0M0200 | 20-200 | 1.146,63 |

FLOTADOR PP ROJO CON IMÁN INTERIOR incorporado para contacto exterior (suministrado aparte)

| | | | |
|----|---------------------|---------|-----------------|
| 25 | FS25D0M0025M | 0,2-2,5 | 414,87 |
| 25 | FS25D0M0004M | 0,3-4 | 414,87 |
| 25 | FS25D0M0065M | 0,5-6,5 | 414,87 |
| 25 | FS25D0M0010M | 1-10 | 414,87 |
| 32 | FS32D0M0004M | 0,4-4 | 444,29 |
| 32 | FS32D0M0065M | 0,5-6,5 | 444,29 |
| 32 | FS32D0M0010M | 1-10 | 444,29 |
| 32 | FS32D0M0016M | 1,5-16 | 444,29 |
| 40 | FS40D0M0016M | 1,5-16 | 565,16 |
| 40 | FS40D0M0025M | 2-25 | 565,16 |
| 40 | FS40D0M0040M | 4-40 | 565,16 |
| 50 | FS50D0M0025M | 2-25 | 583,20 |
| 50 | FS50D0M0040M | 4-40 | 583,20 |
| 50 | FS50D0M0050M | 5-50 | 583,20 |
| 63 | FS63D0M0040M | 4-40 | 823,26 |
| 63 | FS63D0M0064M | 6-64 | 823,26 |
| 63 | FS63D0M0100M | 10-100 | 823,26 |
| 75 | FS75D0M0140M | 15-140 | 1.460,52 |
| 75 | FS75D0M0200M | 20-200 | 1.460,52 |

Flujómetro largo para **Aire**.

Densidad: 1,013 bar abs - 20° C. Cuerpo: **TROGAMID**. Juntas: **EPDM**.



| Ref. | Descripción | € |
|----------------|--|------------------|
| MSMIN01 | Contacto de MÍNIMA para flujómetros FS * | 195,54 |
| MSMAX01 | Contacto de MAXIMA para flujómetros FS * | 195,54 |
| | Escala especial | Consultar |
| | Doble escala | Consultar |

Contactos exteriores.

Sólo utilizables con flujómetros que incorporen imán exterior.

* Para usar con flotador con imán incorporado.



| d | Ref. | Descripción | € |
|----|-----------------|----------------|--------------|
| 25 | QBIC025 | Manguito C-PVC | 11,89 |
| 32 | QBIC032 | Manguito C-PVC | 15,45 |
| 40 | QBIC040 | Manguito C-PVC | 18,96 |
| 50 | QBIC050 | Manguito C-PVC | 29,75 |
| 63 | QBIC063 | Manguito C-PVC | 33,67 |
| 25 | QBIGM025 | Manguito PP-H | 4,39 |
| 32 | QBIGM032 | Manguito PP-H | 4,70 |
| 40 | QBIGM040 | Manguito PP-H | 5,81 |
| 50 | QBIGM050 | Manguito PP-H | 6,94 |
| 63 | QBIGM063 | Manguito PP-H | 7,40 |
| 25 | QBIGF025 | Manguito PVDF | 21,73 |
| 32 | QBIGF032 | Manguito PVDF | 24,22 |
| 40 | QBIGF040 | Manguito PVDF | 30,90 |
| 50 | QBIGF050 | Manguito PVDF | 35,21 |
| 63 | QBIGF063 | Manguito PVDF | 48,83 |

Manguitos.

Para cada flujómetro es necesario pedir 2 manguitos.

| d | Ref. | Descripción | € |
|----|----------------|-------------|--------------|
| 25 | OR4112F | Junta FKM | 2,85 |
| 32 | OR4131F | Junta FKM | 8,05 |
| 40 | OR0150F | Junta FKM | 15,87 |
| 50 | OR4200F | Junta FKM | 12,39 |
| 63 | OR4275F | Junta FKM | 19,70 |
| 75 | OR6325F | Junta FKM | 31,61 |

Juntas.

Para cada flujómetro es necesario pedir 2 juntas.

| d | Ref. | Descripción | € |
|----|----------------|--------------|---------------|
| 25 | EFC114 | Tuerca C-PVC | 7,92 |
| 32 | EFC112 | Tuerca C-PVC | 15,26 |
| 40 | EFC200 | Tuerca C-PVC | 17,36 |
| 50 | EFC214 | Tuerca C-PVC | 28,45 |
| 63 | EFC234 | Tuerca C-PVC | 45,29 |
| 25 | EFGM114 | Tuerca PP-H | 8,56 |
| 32 | EFGM112 | Tuerca PP-H | 9,93 |
| 40 | EFGM200 | Tuerca PP-H | 12,68 |
| 50 | EFGM214 | Tuerca PP-H | 19,65 |
| 63 | EFGM234 | Tuerca PP-H | 31,66 |
| 25 | EFGF114 | Tuerca PVDF | 37,79 |
| 32 | EFGF112 | Tuerca PVDF | 46,88 |
| 40 | EFGF200 | Tuerca PVDF | 64,44 |
| 50 | EFGF214 | Tuerca PVDF | 94,00 |
| 63 | EFGF234 | Tuerca PVDF | 146,16 |

Tuercas.

Para cada flujómetro es necesario pedir 2 tuercas.

Bajo pedido disponemos también de conexiones rosca hembra de 3/8" a 1" en acero inoxidable AISI 316 y en acero al carbono.



M9.02

| Ref. | Montaje | Salidas | Voltaje | € |
|-----------------|----------|---------------------------------|-------------|-----------------|
| M9.02.P1 | En panel | 1x(4-20mA), 2x(S.S.R.), 1 relé | 12-24 VDC | 1.108,44 |
| M9.02.W1 | En pared | 1x(4-20mA), 2x(S.S.R.), 1 relé | 12-24 VDC | 1.282,51 |
| M9.02.W2 | En pared | 1x(4-20mA), 2x(S.S.R.), 1 rele´ | 110-230 VAC | 1.446,93 |

Monitor y transmisor de caudal.

Para sensores de caudal.



M9.02

| Ref. | Longitud sensor | Material sensor | Juntas | Voltaje | € |
|-----------------|-----------------|-----------------|--------|-----------|-----------------|
| M9.02.01 | L0 | C-PVC | EPDM | 12-24 VDC | 1.871,06 |
| M9.02.02 | L0 | C-PVC | FKM | 12-24 VDC | 1.871,06 |
| M9.02.03 | L1 | PVDF | EPDM | 12-24 VDC | 1.900,78 |
| M9.02.04 | L1 | PVDF | FKM | 12-24 VDC | 1.900,78 |
| M9.02.05 | L0 | PVDF | EPDM | 12-24 VDC | 2.069,11 |
| M9.02.06 | L0 | PVDF | FKM | 12-24 VDC | 2.069,11 |
| M9.02.07 | L1 | PVDF | EPDM | 12-24 VDC | 2.378,56 |
| M9.02.08 | L1 | PVDF | FKM | 12-24 VDC | 2.378,56 |
| M9.02.09 | L0 | INOX 316 L | EPDM | 12-24 VDC | 2.357,00 |
| M9.02.10 | L0 | INOX 316 L | FKM | 12-24 VDC | 2.357,00 |
| M9.02.11 | L1 | INOX 316 L | EPDM | 12-24 VDC | 2.409,89 |
| M9.02.12 | L1 | INOX 316 L | FKM | 12-24 VDC | 2.409,89 |

Monitor y transmisor de caudal con sensor de paletas

Montaje directo y compacto. Salidas 1x(4-20mA), 2x(S.S.R.), 1 relé.



M9.00

| Ref. | Montaje | Salidas | Voltaje | € |
|-----------------|----------|------------------------|-------------|-----------------|
| M9.00.P1 | En panel | 1x(4-20mA), 1x(S.S.R.) | 12-24 VDC | 997,71 |
| M9.00.W1 | En pared | 1x(4-20mA), 1x(S.S.R.) | 12-24 VDC | 1.171,83 |
| M9.00.W2 | En pared | 1x(4-20mA), 1x(S.S.R.) | 110-230 VAC | 1.336,25 |

Monitor y transmisor de caudal **2 HILOS**.

Para sensores de caudal.

Longitud L0 para diámetros de ø 20-110 mm. Longitud L1 para diámetros de 125-450 mm.

El pedido estándar se compone de sensor + pantalla + accesorios de conexión al tubo. Disponemos de instrucciones de funcionamiento de los modelos.



M9.00

| Ref. | Longitud sensor | Material sensor | Juntas | Voltaje | € |
|-----------------|-----------------|-----------------|--------|-----------|-----------------|
| M9.00.01 | L0 | C-PVC | EPDM | 12-24 VDC | 1.748,13 |
| M9.00.02 | L0 | C-PVC | FKM | 12-24 VDC | 1.748,13 |
| M9.00.03 | L1 | PVDF | EPDM | 12-24 VDC | 1.777,85 |
| M9.00.04 | L1 | PVDF | FKM | 12-24 VDC | 1.777,85 |
| M9.00.05 | L0 | PVDF | EPDM | 12-24 VDC | 1.946,17 |
| M9.00.06 | L0 | PVDF | FKM | 12-24 VDC | 1.946,17 |
| M9.00.07 | L1 | PVDF | EPDM | 12-24 VDC | 2.255,65 |
| M9.00.08 | L1 | PVDF | FKM | 12-24 VDC | 2.255,65 |
| M9.00.09 | L0 | INOX 316 L | EPDM | 12-24 VDC | 2.234,09 |
| M9.00.10 | L0 | INOX 316 L | FKM | 12-24 VDC | 2.234,09 |
| M9.00.11 | L1 | INOX 316 L | EPDM | 12-24 VDC | 2.286,98 |
| M9.00.12 | L1 | INOX 316 L | FKM | 12-24 VDC | 2.286,98 |

Monitor y transmisor de caudal **2 HILOS**.

con sensor de paletas

Montaje directo y compacto. Salidas 1x(4-20mA), 2x(S.S.R.).

M9.20



| Ref. | Montaje | € |
|-----------------|----------|-----------------|
| M9.20.P1 | En panel | 1.147,37 |
| M9.20.W1 | En pared | 1.321,49 |

Monitor de caudal. **A BATERÍAS.**

Para sensores de caudal.

M9.20



| Ref. | Longitud sensor | Material sensor | Juntas | € |
|-----------------|-----------------|-----------------|--------|-----------------|
| M9.20.01 | L0 | C-PVC | EPDM | 1.914,36 |
| M9.20.02 | L0 | C-PVC | FKM | 1.914,36 |
| M9.20.03 | L1 | PVDF | EPDM | 1.944,09 |
| M9.20.04 | L1 | PVDF | FKM | 1.944,09 |
| M9.20.05 | L0 | PVDF | EPDM | 2.112,44 |
| M9.20.06 | L0 | PVDF | FKM | 2.112,44 |
| M9.20.07 | L1 | PVDF | EPDM | 2.421,91 |
| M9.20.08 | L1 | PVDF | FKM | 2.421,91 |
| M9.20.09 | L0 | INOX 316 L | EPDM | 2.400,38 |
| M9.20.10 | L0 | INOX 316 L | FKM | 2.400,38 |
| M9.20.11 | L1 | INOX 316 L | EPDM | 2.453,24 |
| M9.20.12 | L1 | INOX 316 L | FKM | 2.453,24 |

Monitor de caudal con sensor de paletas **A BATERÍAS.**

Montaje directo y compacto.

M9.50



| Ref. | Montaje | Salidas | Voltaje | € |
|-----------------|----------|---------------------------------|-------------|-----------------|
| M9.50.P1 | En panel | 2x(4-20mA), 2x(S.S.R.), 2 relés | 12-24 VDC | 1.529,53 |
| M9.50.W1 | En pared | 2x(4-20mA), 2x(S.S.R.), 2 relés | 12-24 VDC | 1.749,44 |
| M9.50.W2 | En pared | 2x(4-20mA), 2x(S.S.R.), 2 relés | 110-230 VAC | 1.959,42 |

Monitor de control de trasvase. Para sensores de caudal.

M9.03



| Ref. | Montaje | Salidas | Voltaje | € |
|-----------------|----------|---------------------------------|-------------|-----------------|
| M9.03.P1 | En panel | 2x(4-20mA), 2x(S.S.R.), 2 relés | 12-24 VDC | 1.972,33 |
| M9.03.W1 | En pared | 2x(4-20mA), 2x(S.S.R.), 2 relés | 12-24 VDC | 2.204,42 |
| M9.03.W2 | En pared | 2x(4-20mA), 2x(S.S.R.), 2 relés | 110-230 VAC | 2.423,64 |

Monitor y transmisor de caudal **DOBLE** Para sensores de caudal.

M9.05



| Ref. | Montaje | Salidas | Voltaje | € |
|-----------------|----------|---------------------------------|-------------|-----------------|
| M9.05.P1 | En panel | 2x(4-20mA), 2x(S.S.R.), 2 relés | 12-24 VDC | 1.475,08 |
| M9.05.W1 | En pared | 2x(4-20mA), 2x(S.S.R.), 2 relés | 12-24 VDC | 1.707,14 |
| M9.05.W2 | En pared | 2x(4-20mA), 2x(S.S.R.), 2 relés | 110-230 VAC | 1.926,30 |

Monitor y transmisor de conductividad. Para sensores de conductividad.

Longitud L0 para diámetros de ø 20-110 mm. Longitud L1 para diámetros de 125-450 mm.

El pedido estándar se compone de sensor + pantalla + accesorios de conexión al tubo. Disponemos de instrucciones de funcionamiento de los modelos.

M9.06



| Ref. | Montaje | Salidas | Voltaje | € |
|-----------------|----------|---------------------------------|-------------|-----------------|
| M9.06.P1 | En panel | 2x(4-20mA), 2x(S.S.R.), 2 relés | 12-24 VDC | 1.486,96 |
| M9.06.W1 | En pared | 2x(4-20mA), 2x(S.S.R.), 2 relés | 12-24 VDC | 1.719,02 |
| M9.06.W2 | En pared | 2x(4-20mA), 2x(S.S.R.), 2 relés | 110-230 VAC | 1.938,17 |

Monitor y transmisor de pH / ORP.

Para sensores de pH/ORP.

M9.07



| Ref. | Montaje | Salidas | Voltaje | € |
|-----------------|----------|---------------------------------|-------------|-----------------|
| M9.07.P1 | En panel | 2x(4-20mA), 2x(S.S.R.), 2 relés | 12-24 VDC | 1.969,56 |
| M9.07.W1 | En pared | 2x(4-20mA), 2x(S.S.R.), 2 relés | 12-24 VDC | 2.201,76 |
| M9.07.W2 | En pared | 2x(4-20mA), 2x(S.S.R.), 2 relés | 110-230 VAC | 2.420,95 |

Monitor y transmisor de doble par metro: **CONDUCTIVIDAD - CAUDAL.**

M9.08



| Ref. | Montaje | Salidas | Voltaje | € |
|-----------------|----------|---------------------------------|-------------|-----------------|
| M9.08.P1 | En panel | 2x(4-20mA), 2x(S.S.R.), 2 relés | 12-24 VDC | 1.981,56 |
| M9.08.W1 | En pared | 2x(4-20mA), 2x(S.S.R.), 2 relés | 12-24 VDC | 2.213,61 |
| M9.08.W2 | En pared | 2x(4-20mA), 2x(S.S.R.), 2 relés | 110-230 VAC | 2.432,81 |

Monitor y transmisor de doble par metro: **pH / ORP - CAUDAL.**

M9.10



| Ref. | Montaje | Salidas | Voltaje | € |
|-----------------|----------|---------------------------------|-------------|-----------------|
| M9.10.P1 | En panel | 2x(4-20mA), 2x(S.S.R.), 2 relés | 12-24 VDC | 1.879,34 |
| M9.10.W1 | En pared | 2x(4-20mA), 2x(S.S.R.), 2 relés | 12-24 VDC | 2.111,43 |
| M9.10.W2 | En pared | 2x(4-20mA), 2x(S.S.R.), 2 relés | 110-230 VAC | 2.330,65 |

Monitor y transmisor analógico de doble parámetro.

Longitud L0 para diámetros de ø 20-110 mm. Longitud L1 para diámetros de 125-450 mm.

El pedido estándar se compone de sensor + pantalla + accesorios de conexión al tubo. Disponemos de instrucciones de funcionamiento de los modelos.



F3.00.H.XX

| Ref. | Longitud sensor | Material sensor | Juntas | Protección | € |
|-------------------|-----------------|-----------------|--------|------------|-----------------|
| F3.00.H.01 | L0 | C-PVC | EPDM | IP68 | 521,61 |
| F3.00.H.02 | L0 | C-PVC | FKM | IP68 | 521,61 |
| F3.00.H.03 | L1 | C-PVC | EPDM | IP68 | 547,62 |
| F3.00.H.04 | L1 | C-PVC | FKM | IP68 | 547,62 |
| F3.00.H.05 | L0 | PVDF | EPDM | IP68 | 697,96 |
| F3.00.H.06 | L0 | PVDF | FKM | IP68 | 697,96 |
| F3.00.H.07 | L1 | PVDF | EPDM | IP68 | 905,87 |
| F3.00.H.08 | L1 | PVDF | FKM | IP68 | 905,87 |
| F3.00.H.09 | L0 | INOX 316 | EPDM | IP68 | 976,78 |
| F3.00.H.10 | L0 | INOX 316 | FKM | IP68 | 976,78 |
| F3.00.H.11 | L1 | INOX 316 | EPDM | IP68 | 1.025,47 |
| F3.00.H.12 | L1 | INOX 316 | FKM | IP68 | 1.025,47 |

Sensor de caudal de paletas version remota

Alimentación 12-24 VDC. **VERSIÓN HALL.**



| Ref. | Longitud sensor | Material sensor | Juntas | Protección | € |
|-------------------|-----------------|-----------------|--------|------------|-----------------|
| F3.00.H.13 | L0 | C-PVC | EPDM | IP65 | 521,61 |
| F3.00.H.14 | L0 | C-PVC | FKM | IP65 | 521,61 |
| F3.00.H.15 | L1 | C-PVC | EPDM | IP65 | 547,62 |
| F3.00.H.16 | L1 | C-PVC | FKM | IP65 | 547,62 |
| F3.00.H.17 | L0 | PVDF | EPDM | IP65 | 697,96 |
| F3.00.H.18 | L0 | PVDF | FKM | IP65 | 697,96 |
| F3.00.H.19 | L1 | PVDF | EPDM | IP65 | 905,87 |
| F3.00.H.20 | L1 | PVDF | FKM | IP65 | 905,87 |
| F3.00.H.21 | L0 | INOX 316 | EPDM | IP65 | 976,78 |
| F3.00.H.22 | L0 | INOX 316 | FKM | IP65 | 976,78 |
| F3.00.H.23 | L1 | INOX 316 | EPDM | IP65 | 1.025,47 |
| F3.00.H.24 | L1 | INOX 316 | FKM | IP65 | 1.025,47 |

Marcados en amarillo los modelos estándar

F3.00.C.XX

| Ref. | Longitud sensor | Material sensor | Juntas | Protección | € |
|-------------------|-----------------|-----------------|--------|------------|-----------------|
| F3.00.C.01 | L0 | C-PVC | EPDM | IP68 | 521,61 |
| F3.00.C.02 | L0 | C-PVC | FKM | IP68 | 521,61 |
| F3.00.C.03 | L1 | C-PVC | EPDM | IP68 | 547,62 |
| F3.00.C.04 | L1 | C-PVC | FKM | IP68 | 547,62 |
| F3.00.C.05 | L0 | PVDF | EPDM | IP68 | 697,96 |
| F3.00.C.06 | L0 | PVDF | FKM | IP68 | 697,96 |
| F3.00.C.07 | L1 | PVDF | EPDM | IP68 | 905,87 |
| F3.00.C.08 | L1 | PVDF | FKM | IP68 | 905,87 |
| F3.00.C.09 | L0 | INOX 316 | EPDM | IP68 | 976,78 |
| F3.00.C.10 | L0 | INOX 316 | FKM | IP68 | 976,78 |
| F3.00.C.11 | L1 | INOX 316 | EPDM | IP68 | 1.025,47 |
| F3.00.C.12 | L1 | INOX 316 | FKM | IP68 | 1.025,47 |

Sensor de caudal de paletas version remota

Alimentación 3-5 VDC. **VERSIÓN COIL.**



| Ref. | Longitud sensor | Material sensor | Juntas | Protección | € |
|-------------------|-----------------|-----------------|--------|------------|-----------------|
| F3.00.C.13 | L0 | C-PVC | EPDM | IP65 | 521,61 |
| F3.00.C.14 | L0 | C-PVC | FKM | IP65 | 521,61 |
| F3.00.C.15 | L1 | C-PVC | EPDM | IP65 | 547,62 |
| F3.00.C.16 | L1 | C-PVC | FKM | IP65 | 547,62 |
| F3.00.C.17 | L0 | PVDF | EPDM | IP65 | 697,96 |
| F3.00.C.18 | L0 | PVDF | FKM | IP65 | 697,96 |
| F3.00.C.19 | L1 | PVDF | EPDM | IP65 | 905,87 |
| F3.00.C.20 | L1 | PVDF | FKM | IP65 | 905,87 |
| F3.00.C.21 | L0 | INOX 316 | EPDM | IP65 | 976,78 |
| F3.00.C.22 | L0 | INOX 316 | FKM | IP65 | 976,78 |
| F3.00.C.23 | L1 | INOX 316 | EPDM | IP65 | 1.025,47 |
| F3.00.C.24 | L1 | INOX 316 | FKM | IP65 | 1.025,47 |

Longitud L0 para diámetros de ø 20-110 mm. Longitud L1 para diámetros de 125-450 mm.

El pedido estándar se compone de sensor + pantalla + accesorios de conexión al tubo. Disponemos de instrucciones de funcionamiento de los modelos.

F3.00.P.XX

| Ref. | Longitud sensor | Material sensor | Juntas | Protección | € |
|-------------------|-----------------|-----------------|--------|------------|-----------------|
| F3.00.P.01 | L0 | C-PVC | EPDM | IP68 | 547,62 |
| F3.00.P.02 | L0 | C-PVC | FKM | IP68 | 547,62 |
| F3.00.P.03 | L1 | C-PVC | EPDM | IP68 | 560,61 |
| F3.00.P.04 | L1 | C-PVC | FKM | IP68 | 560,61 |
| F3.00.P.05 | L0 | PVDF | EPDM | IP68 | 729,51 |
| F3.00.P.06 | L0 | PVDF | FKM | IP68 | 729,51 |
| F3.00.P.07 | L1 | PVDF | EPDM | IP68 | 924,41 |
| F3.00.P.08 | L1 | PVDF | FKM | IP68 | 924,41 |
| F3.00.P.09 | L0 | INOX 316 | EPDM | IP68 | 989,40 |
| F3.00.P.10 | L0 | INOX 316 | FKM | IP68 | 989,40 |
| F3.00.P.11 | L1 | INOX 316 | EPDM | IP68 | 1.039,87 |
| F3.00.P.12 | L1 | INOX 316 | FKM | IP68 | 1.039,87 |

Sensor de caudal de paletas version remota

Alimentación 12-24 VDC. [Para conexión directa a PLC.](#)



F3.01.H.XX

| Ref. | Longitud sensor | Material sensor | Juntas | Protección | € |
|-------------------|-----------------|-----------------|--------|------------|-----------------|
| F3.00.C.01 | L0 | C-PVC | EPDM | IP68 | 521,61 |
| F3.00.C.02 | L0 | C-PVC | FKM | IP68 | 521,61 |
| F3.00.C.03 | L1 | C-PVC | EPDM | IP68 | 547,62 |
| F3.00.C.04 | L1 | C-PVC | FKM | IP68 | 547,62 |
| F3.00.C.05 | L0 | PVDF | EPDM | IP68 | 697,96 |
| F3.00.C.06 | L0 | PVDF | FKM | IP68 | 697,96 |
| F3.00.C.07 | L1 | PVDF | EPDM | IP68 | 905,87 |
| F3.00.C.08 | L1 | PVDF | FKM | IP68 | 905,87 |
| F3.00.C.09 | L0 | INOX 316 | EPDM | IP68 | 976,78 |
| F3.00.C.10 | L0 | INOX 316 | FKM | IP68 | 976,78 |
| F3.00.C.11 | L1 | INOX 316 | EPDM | IP68 | 1.025,47 |
| F3.00.C.12 | L1 | INOX 316 | FKM | IP68 | 1.025,47 |

Sensor de caudal de paletas version remota versión compacta.

Alimentación 5-24 VDC. [VERSIÓN COIL.](#)



| Ref. | Longitud sensor | Material sensor | Juntas | Protección | € |
|-------------------|-----------------|-----------------|--------|------------|-----------------|
| F3.00.P.13 | L0 | C-PVC | EPDM | IP65 | 547,62 |
| F3.00.P.14 | L0 | C-PVC | FKM | IP65 | 547,62 |
| F3.00.P.15 | L1 | C-PVC | EPDM | IP65 | 560,61 |
| F3.00.P.16 | L1 | C-PVC | FKM | IP65 | 560,61 |
| F3.00.P.17 | L0 | PVDF | EPDM | IP65 | 729,51 |
| F3.00.P.18 | L0 | PVDF | FKM | IP65 | 729,51 |
| F3.00.P.19 | L1 | PVDF | EPDM | IP65 | 924,41 |
| F3.00.P.20 | L1 | PVDF | FKM | IP65 | 924,41 |
| F3.00.P.21 | L0 | INOX 316 | EPDM | IP65 | 989,40 |
| F3.00.P.22 | L0 | INOX 316 | FKM | IP65 | 989,40 |
| F3.00.P.23 | L1 | INOX 316 | EPDM | IP65 | 1.039,87 |
| F3.00.P.24 | L1 | INOX 316 | FKM | IP65 | 1.039,87 |

Sensor de caudal de paletas version remota

Alimentación 12-24 VDC. [Para conexión directa a PLC.](#)



F3.01.C.XX

| Ref. | Longitud sensor | Material sensor | Juntas | Protección | € |
|-------------------|-----------------|-----------------|--------|------------|-----------------|
| F3.00.C.13 | L0 | C-PVC | EPDM | IP65 | 521,61 |
| F3.00.C.14 | L0 | C-PVC | FKM | IP65 | 521,61 |
| F3.00.C.15 | L1 | C-PVC | EPDM | IP65 | 547,62 |
| F3.00.C.16 | L1 | C-PVC | FKM | IP65 | 547,62 |
| F3.00.C.17 | L0 | PVDF | EPDM | IP65 | 697,96 |
| F3.00.C.18 | L0 | PVDF | FKM | IP65 | 697,96 |
| F3.00.C.19 | L1 | PVDF | EPDM | IP65 | 905,87 |
| F3.00.C.20 | L1 | PVDF | FKM | IP65 | 905,87 |
| F3.00.C.21 | L0 | INOX 316 | EPDM | IP65 | 976,78 |
| F3.00.C.22 | L0 | INOX 316 | FKM | IP65 | 976,78 |
| F3.00.C.23 | L1 | INOX 316 | EPDM | IP65 | 1.025,47 |
| F3.00.C.24 | L1 | INOX 316 | FKM | IP65 | 1.025,47 |

Sensor de caudal de paletas version remota versión compacta.

Alimentación 3-5 VDC. [VERSIÓN COIL.](#)

Longitud L0 para diámetros de ø 20-110 mm. Longitud L1 para diámetros de 125-450 mm.

El pedido estándar se compone de sensor + pantalla + accesorios de conexión al tubo. Disponemos de instrucciones de funcionamiento de los modelos.



F3.20.X.01

| Ref. | Longitud sensor | Material sensor | Versión | Protección | € |
|-------------------|-----------------|-----------------|---------------|------------|---------------|
| F3.20.H.01 | 107 | INOX 316 | HALL | IP68 | 818,90 |
| F3.20.P.01 | 107 | INOX 316 | Directo a PLC | IP68 | 859,83 |

Sensor de caudal de paletas para
ALTAS PRESIONES Y TEMPERATURAS.



F3.10.H.XX

| Ref. | Longitud sensor | Material sensor | Juntas | Protección | € |
|-------------------|-----------------|-----------------|--------|------------|---------------|
| F3.10.H.01 | 41 | ABS | EPDM | IP65 | 215,29 |
| F3.10.H.02 | 41 | ABS | FKM | IP65 | 215,38 |

Minisensor de caudal de paletas
 Alimentación 5-24 VDC. **VERSIÓN HALL.**



F6.30

| Ref. | Longitud sensor | Material sensor | Juntas | Protección | € |
|-----------------|-----------------|-----------------|--------|------------|-----------------|
| F6.30.01 | L0 | C-PVC | EPDM | IP65 | 1.372,08 |
| F6.30.02 | L0 | C-PVC | FKM | IP65 | 1.372,08 |
| F6.30.03 | L1 | C-PVC | EPDM | IP65 | 1.403,80 |
| F6.30.04 | L1 | C-PVC | FKM | IP65 | 1.403,80 |
| F6.30.05 | L0 | PVDF | EPDM | IP65 | 1.583,59 |
| F6.30.06 | L0 | PVDF | FKM | IP65 | 1.583,59 |
| F6.30.07 | L1 | PVDF | EPDM | IP65 | 1.914,03 |
| F6.30.08 | L1 | PVDF | FKM | IP65 | 1.914,03 |
| F6.30.09 | L0 | INOX 316 | EPDM | IP65 | 1.924,64 |
| F6.30.10 | L0 | INOX 316 | FKM | IP65 | 1.924,64 |
| F6.30.11 | L1 | INOX 316 | EPDM | IP65 | 1.982,77 |
| F6.30.12 | L1 | INOX 316 | FKM | IP65 | 1.982,77 |

Transmisor de caudal de paletas **CON SALIDA 4-20 mA.**

Alimentación 5-24 VDC. **VERSIÓN COIL.**

Rango caudal: 0,15 - 8 m/s.



F3.05.XX

| Ref. | Longitud sensor | Material sensor | Juntas | Protección | € |
|-----------------|-----------------|-----------------|--------|------------|---------------|
| F3.05.01 | L0 | C-PVC | EPDM | IP65 | 468,58 |
| F3.05.02 | L0 | C-PVC | FKM | IP65 | 468,58 |
| F3.05.03 | L1 | PVDF | EPDM | IP65 | 497,42 |
| F3.05.04 | L1 | PVDF | FKM | IP65 | 497,42 |
| F3.05.05 | L0 | PVDF | EPDM | IP65 | 731,73 |
| F3.05.06 | L0 | PVDF | FKM | IP65 | 731,73 |
| F3.05.07 | L1 | PVDF | EPDM | IP65 | 776,76 |
| F3.05.08 | L1 | PVDF | FKM | IP65 | 776,76 |
| F3.05.09 | L0 | INOX 316 | EPDM | IP65 | 888,51 |
| F3.05.10 | L0 | INOX 316 | FKM | IP65 | 888,51 |
| F3.05.11 | L1 | INOX 316 | EPDM | IP65 | 933,59 |
| F3.05.12 | L1 | INOX 316 | FKM | IP65 | 933,59 |

Sensor de caudal de paletas

INTERRUPTOR DE CAUDAL. BATCH CONTROLER.

Transmite una señal de apertura al detectar ausencia de caudal.

Longitud L0 para diámetros de \varnothing 20-110 mm. Longitud L1 para diámetros de 125-450 mm.

El pedido estándar se compone de sensor + pantalla + accesorios de conexión al tubo. Disponemos de instrucciones de funcionamiento de los modelos.



F6.60

| Ref. | Longitud sensor | Material sensor | Juntas | Protección | € |
|-----------------|-----------------|-----------------|--------|------------|-----------------|
| F6.60.09 | L0 | INOX 316L/PVDF | EPDM | IP65 | 2.182,98 |
| F6.60.10 | L0 | INOX 316L/PVDF | FKM | IP65 | 2.182,98 |
| F6.60.11 | L1 | INOX 316L/PVDF | EPDM | IP65 | 2.241,37 |
| F6.60.12 | L1 | INOX 316L/PVDF | FKM | IP65 | 2.241,37 |
| F6.60.33 | L0 | CuNI/PVDF | EPDM | IP65 | 2.387,40 |
| F6.60.34 | L0 | CuNI/PVDF | FKM | IP65 | 2.387,40 |
| F6.60.35 | L1 | CuNI/PVDF | EPDM | IP65 | 2.445,77 |
| F6.60.36 | L1 | CuNI/PVDF | FKM | IP65 | 2.445,77 |
| F6.60.38 | L0 | INOX 316/PEEK | FKM | IP65 | 2.387,40 |
| F6.60.40 | L1 | INOX 316/PEEK | FKM | IP65 | 2.445,77 |

Sensor de caudal electromagnético **BIDIRECCIONAL**.
Alimentación 12-24 VDC. **VERSIÓN CIEGA**. Rango caudal: 0,15 - 8 m/s.



F6.63

| Ref. | Longitud sensor | Material sensor | Juntas | Protección | € |
|-----------------|-----------------|-----------------|--------|------------|-----------------|
| F6.63.09 | L0 | INOX 316L/PVDF | EPDM | IP65 | 1.855,75 |
| F6.63.10 | L0 | INOX 316L/PVDF | FKM | IP65 | 1.855,75 |
| F6.63.11 | L1 | INOX 316L/PVDF | EPDM | IP65 | 1.905,38 |
| F6.63.12 | L1 | INOX 316L/PVDF | FKM | IP65 | 1.905,38 |
| F6.63.33 | L0 | CuNI/PVDF | EPDM | IP65 | 2.029,51 |
| F6.63.34 | L0 | CuNI/PVDF | FKM | IP65 | 2.029,51 |
| F6.63.35 | L1 | CuNI/PVDF | EPDM | IP65 | 2.079,16 |
| F6.63.36 | L1 | CuNI/PVDF | FKM | IP65 | 2.079,16 |
| F6.63.38 | L0 | INOX 316/PEEK | EPDM | IP65 | 2.029,51 |
| F6.63.40 | L1 | INOX 316/PEEK | FKM | IP65 | 2.079,16 |

Sensor de caudal electromagnético **MONODIRECCIONAL**.
Alimentación 12-24 VDC. **VERSIÓN CIEGA**. Rango caudal: 0,15 - 8 m/s.



F6.61.01

| Ref. | Material cuerpo | Protección | Longitud mm.. | € |
|-----------------|-------------------------|------------|---------------|-----------------|
| F6.61.01 | INOX 304/PVDF/INOX 316L | EPDM | IP65 | 4.703,79 |

Sensor de caudal electromagnético para tomas en carga.
Alimentación 12-24 VDC. **VERSIÓN HOT TAP**.
Rango caudal: 0,15 - 8 m/s.



F3.8X.H.OX

| Ref. | Caudal | Material | Engranajes | Juntas | € |
|-------------------|------------|------------|------------|--------|-----------------|
| F3.81.H.01 | 10-100 l/h | PP | ECTFE | FKM | 974,18 |
| F3.81.H.02 | 10-100 l/h | ECTFE | ECTFE | FKM | 1.433,45 |
| F3.81.H.03 | 10-100 l/h | INOX 316 L | ECTFE | FKM | 1.827,08 |
| F3.82.H.01 | 25-150 l/h | PP | ECTFE | FKM | 974,18 |
| F3.82.H.02 | 25-150 l/h | ECTFE | ECTFE | FKM | 1.433,45 |
| F3.82.H.03 | 25-150 l/h | INOX 316 L | ECTFE | FKM | 1.827,08 |

Sensor oval para caudales bajos. Versión especial con salida
Alimentación 12-24 VDC. Protección n IP65. 4-20mA bajo pedido



ULF01.X.X

R

| Ref. | Voltaje | Versión | Material | € |
|------------------|----------|---------|--------------|-----------------|
| ULF01.H.0 | 5-24 VDC | HALL | POM-FKM | 334,61 |
| ULF01.H.2 | 5-24 VDC | HALL | ECTFE-FKM | 826,59 |
| ULF01.H.3 | 5-24 VDC | HALL | ECTFE-KALREZ | 1.292,41 |
| ULF01.R.0 | - | REED | POM-FKM | 364,09 |
| ULF01.R.2 | - | REED | ECTFE-FKM | 777,41 |
| ULF01.R.3 | - | REED | ECTFE-KALREZ | 1.216,96 |

Sensor para caudales bajos entre 1,5-100 l/h. Protección IP65.



ULF03.X.X

R

| Ref. | Voltaje | Versión | Material | € |
|------------------|----------|---------|--------------|-----------------|
| ULF03.H.0 | 5-24 VDC | HALL | POM-FKM | 334,61 |
| ULF03.H.2 | 5-24 VDC | HALL | ECTFE-FKM | 826,59 |
| ULF03.H.3 | 5-24 VDC | HALL | ECTFE-KALREZ | 1.292,41 |
| ULF03.R.0 | - | REED | POM-FKM | 364,09 |
| ULF03.R.2 | - | REED | ECTFE-FKM | 777,41 |
| ULF03.R.3 | - | REED | ECTFE-KALREZ | 1.216,96 |

Sensor para caudales bajos entre 6-250 l/h. Protección IP65.

Longitud L0 para diámetros de ø 20-110 mm. Longitud L1 para diámetros de 125-450 mm.
El pedido estándar se compone de sensor + pantalla + accesorios de conexión al tubo. Disponemos de instrucciones de funcionamiento de los modelos.



pH200/ORP200

| Ref. | Descripción | Cable (venta aparte) | Salidas | Instalación | € |
|------------------|--|----------------------|------------------|--|---------------|
| PH200C | Electrodo combinado pH/referencia | No necesario | 5 metros cable | EG50P, EG75P, MK150200, MIFV20X05, MIMC20X05 | 276,26 |
| PH222CD | Electrodo combinado pH/referencia doble toma tipo cartucho | CN653, CN653TC1 | Twist-Lock (BNC) | EG50P, EG75P, MIFV20X05, MIMC20X05 | 341,60 |
| PH223CD | Electrodo combinado pH/referencia doble toma tipo cartucho para accesorios FLS | CN653 | Twist-Lock (BNC) | F3.SP2.4 | 395,04 |
| PH222CDTC | Electrodo combinado pH/referencia doble toma tipo cartucho con Pt 1000 | CN653 | Twist-Lock (BNC) | F3.SP2.4 | 879,76 |
| ORP200C | Electrodo combinado ORP/referencia | No necesario | 5 metros cable | EG50P, EG75P, MK150200, MIFV20X05, MIMC20X05 | 371,28 |
| ORP222CD | Electrodo combinado ORP/referencia doble toma tipo cartucho | CN653 | Twist-Lock (BNC) | EG50P, EG75P, MIFV20X05, MIMC20X05 | 536,49 |
| ORP223CD | Electrodo combinado de ORP/referencia doble toma tipo cartucho para accesorios FLS | CN653 | Twist-Lock (BNC) | F3.SP2.4 | 592,68 |

Electrodo de pH / Electrodo de ORP.

Rango de funcionamiento: 0-14 pH / Rango de funcionamiento: ± 2000 Mv.

Cuerpo epóxico



pH400/ORP400

| Ref. | Descripción | Cable (venta aparte) | Salidas | Instalación | € |
|-----------------|---|----------------------|---------|-----------------|-----------------|
| PH431CD | Electrodo combinado de pH/referencia doble toma | No necesario | S7 | GEG135 | 891,19 |
| PH435CD | Electrodo combinado de pH/referencia doble toma para altas temperaturas | CE5S7 | S7 | GEG135, EG135SE | 1.086,29 |
| ORP431CD | Electrodo combinado de ORP/referencia de doble toma | No necesario | S7 | GEG135 | 995,89 |

Electrodo de pH / Electrodo de ORP.

Rango de funcionamiento: 0-14 pH / Rango de funcionamiento: ± 1000 Mv.

Cuerpo de cristal.

ORP600/pH600



| Ref. | Descripción | Cable (venta aparte) | Conexión | Instalación | € |
|-------------------|---|----------------------|------------------|----------------------|-----------------|
| ORP660CD | Electrodo de superficie plana combinado de ORP con doble toma de C-PVC | CN653 | Twist-Lock (BNC) | EG66P, MK660 | 923,77 |
| ORP650CD | Electrodo de superficie plana combinado de ORP con doble toma de C-PVC | CN653 / CN653 TC1 | Twist-Lock (BNC) | MIFV20X05, MIMC20X05 | 923,77 |
| ORP655CD | Electrodo de superficie plana combinado de ORP con doble toma de C-PVC y gel de relleno presurizado | CN653 | Twist-Lock (BNC) | WT675, WT675 TC1 | 969,81 |
| ORP660CDDA | Electrodo combinado de pH/ORP de superficie plana con interrupción de bucle de tierra. Aplicaciones: presencia de corrientes parásitas | CN653 | Twist-Lock (BNC) | EG66P, MK660 | 1.752,51 |
| ORP650CDDA | Electrodo combinado de pH/ORP de superficie plana con interrupción de bucle de tierra. Aplicaciones: presencia de corrientes parásitas | CN653 / CN653 TC1 | Twist-Lock (BNC) | MIFV20X05, MIMC20X05 | 1.701,06 |
| PH660CD | Electrodo de pH superficie plana combinado doble toma de C-PVC | CN653 | Twist-Lock (BNC) | EG66P, MK660 | 778,20 |
| PH650CD | Electrodo de pH superficie plana combinado doble toma de C-PVC | CN653 / CN653 TC1 | Twist-Lock (BNC) | MIFV20X05, MIMC20X05 | 778,20 |
| PH655CD | Electrodo de pH superficie plana combinado, doble toma de C-PVC y con gel de relleno presurizado | CN653 | Twist-Lock (BNC) | WT675, WT675 TC1 | 816,81 |
| PH660CDHF | Electrodo de pH superficie plana combinado doble toma de C-PVC. Líquidos con HF (máx. 2%) | CN653 | Twist-Lock (BNC) | EG66P, MK660 | 952,01 |
| PH650CDHF | Electrodo de pH superficie plana combinado doble toma de C-PVC. Líquidos con HF (máx. 2%) | CN653 / CN653 TC1 | Twist-Lock (BNC) | MIFV20X05, MIMC20X05 | 1.130,22 |
| PH655CDHF | Electrodo de pH superficie plana combinado, doble toma de C-PVC y con gel de relleno presurizado. Líquidos con HF (máx. 2%) | CN653 | Twist-Lock (BNC) | WT675, WT675 TC1 | 1.130,22 |
| PH660CDDA | Electrodo combinado de pH de superficie plana con interrupción de bucle de tierra. Aplicaciones: presencia de corrientes parásitas | CN653 | Twist-Lock (BNC) | EG66P, MK660 | 1.488,11 |
| PH650CDDA | Electrodo combinado de pH de superficie plana con interrupción de bucle de tierra. Aplicaciones: presencia de corrientes parásitas | CN653 / CN653 TC1 | Twist-Lock (BNC) | MIFV20X05, MIMC20X05 | 1.488,11 |
| PH660CDLC | Electrodo de pH con superficie plana combinado y doble toma de C-PVC. Líquidos con baja conductividad (<100 ms) | CN653 | Twist-Lock (BNC) | EG66P, MK660 | 840,57 |
| PH650CDLC | Electrodo de pH con superficie plana combinado y doble toma de C-PVC. Líquidos con baja conductividad (<100 ms) | CN653 / CN653 TC1 | Twist-Lock (BNC) | MIFV20X05, MIMC20X05 | 990,62 |
| PH655CDLC | Electrodo de pH con superficie plana combinado, doble toma de C-PVC y con gel de relleno presurizado. Líquidos con baja conductividad (<100 ms) | CN653 | Twist-Lock (BNC) | WT675, WT675 TC1 | 990,62 |

Electrodo de ORP / Electrodo de PH.

De superficie plana.

pH800

| Ref. | Descripción | Aplicación / Rango operativo | Conexión | Instalación | € |
|--------------------|---|--|----------|-------------|-----------------|
| PH870CDTDC | Electrodo pH Ryton doble unión con Pt1000 | 0-14 pH (0-12,3 pH sin Na + error) | 5 metros | ¾" NPT | 1.270,11 |
| PH870CDTCHM | Electrodo pH Ryton doble unión con Pt1000 | 0-14 pH (0-12,3 pH sin Na + error) Montaje horizontal | 5 metros | ¾" NPT | 1.379,96 |
| PH870CDTCLC | Electrodo pH Ryton doble unión con Pt1000 | 0-14 pH (0-12,3 pH sin Na + error) Baja conductividad (<100 µS) | 5 metros | ¾" NPT | 1.352,48 |
| PH870CDTCHF | Electrodo pH Ryton doble unión con Pt1000 | 0-14 pH (0-12,3 pH sin Na + error) Presencia de HF (máx 2%) | 5 metros | ¾" NPT | 1.434,91 |

Electrodo de PH.

De superficie plana.



C150/C200

| Ref. | Descripción | Rango funcionamiento | Constante de celda | Conexión | Instalación | € |
|------------------|--|----------------------|--------------------|----------|--|---------------|
| C150.01TC | Sensor de conductividad en grafito con sensor de temperatura | 0,1 µS a 2.000 µS | 0,1 Cell | 5 metros | EG50P, EG75P, MIFV20X05, MIMC20X05 | 520,82 |
| C150.1TC | Sensor de conductividad en grafito con sensor de temperatura | 1µS a 20.000 µS | 1,0 Cell | 5 metros | EG50P, EG75P, MIFV20X05, MIMC20X05, MK150200 | 520,82 |
| C200.01TC | Sensor de conductividad en grafito con sensor de temperatura | 0,1 µS a 2.000 µS | 0,1 Cell | 5 metros | EG50P, EG75P, MIFV20X05, MIMC20X05 | 666,17 |
| C200.1TC | Sensor de conductividad en grafito con sensor de temperatura | 1 µS a 20.000 µS | 1,0 Cell | 5 metros | EG50P, EG75P, MIFV20X05, MIMC20X05 | 666,17 |
| C200.10TC | Sensor de conductividad en grafito con sensor de temperatura | 10 µS a 200.000 µS | 10,0 Cell | 5 metros | EG50P, EG75P, MIFV20X05, MIMC20X05 | 666,17 |

Sensor de conductividad.

De cuerpo epóxico.



C6.30

| Ref. | Descripción | Rango funcionamiento | Conexión | Instalación | € |
|-----------------|--|----------------------|----------|----------------------|-----------------|
| C6.30.01 | Transmisor de conductividad inductivo con sensor de temperatura incluido | 0-10 mS | 3 metros | Rosca macho 1 ½" NPT | 3.487,24 |
| C6.30.02 | Transmisor de conductividad inductivo con sensor de temperatura incluido | 0-100 mS | 3 metros | Rosca macho 1 ½" NPT | 2.212,87 |
| C6.30.03 | Transmisor de conductividad inductivo con sensor de temperatura incluido | 0-1.000 mS | 3 metros | Rosca macho 1 ½" NPT | 2.212,87 |

Transmisor de conductividad inductivo

Cuerpo en C-PVC.



C100/C300

| Ref. | Descripción | Rango funcionamiento | Constante de celda | Conexión | Instalación | € |
|---------------------|--|----------------------|--------------------|---------------------|----------------------|-----------------|
| C100.01TC | Sensor de PP con electrodo de conductividad en acero inox con sensor de temperatura | 0,1 µS a 2.000 µS | 0,1 Cell | Conector 4 clavijas | Rosca macho 3/4" BSP | 466,30 |
| C100.02TC | Sensor de PP con electrodo de conductividad en acero inox con sensor de temperatura | 0,2 µS a 4.000 µS | 0,2 Cell | Conector 4 clavijas | Rosca macho 3/4" BSP | 466,30 |
| C100.1TC | Sensor de PP con electrodo de conductividad en acero inox con sensor de temperatura | 1 µS a 20.000 µS | 1,0 Cell | Conector 4 clavija | Rosca macho 3/4" BSP | 466,30 |
| C300.001TC | Sensor con cuerpo y electrodos de conductividad en acero inox. | 0,055 µS a 200 µS | 0,01 Cell | 3 metros | EG12 SS | 923,50 |
| C300.001TCCK | Sensor con cuerpo y electrodo de conductividad en acero inox. con certificado de constante de Cell | 0,055 µS a 200 µS | 0,01 Cell | 3 metros | EG12 SS | 1.176,71 |
| C300.10TC | Sensor con cuerpo y electrodos de conductividad en acero inox. | 10 µS a 200.000 µS | 10,0 Cell | 3 metros | EG12 SS | 923,50 |

Sensor de conductividad.

C100 cuerpo en PP y C300 cuerpo en inox.



| d x Rh | Ref. | DN | Material | Longitud sensor | Juntas | € |
|--------|----------------|----|----------|-----------------|--------|---------------|
| 20 | TFIV20B | 15 | PVC-U | L0 | EPDM | 134,62 |
| 25 | TFIV25B | 20 | PVC-U | L0 | EPDM | 134,62 |
| 32 | TFIV32B | 25 | PVC-U | L0 | EPDM | 169,19 |
| 40 | TFIV40B | 32 | PVC-U | L0 | EPDM | 169,19 |
| 50 | TFIV50B | 40 | PVC-U | L0 | EPDM | 188,44 |
| 20 | TFIV20D | 15 | PVC-U | L0 | FKM | 134,62 |
| 25 | TFIV25D | 20 | PVC-U | L0 | FKM | 134,62 |
| 32 | TFIV32D | 25 | PVC-U | L0 | FKM | 169,19 |
| 40 | TFIV40D | 32 | PVC-U | L0 | FKM | 169,19 |
| 50 | TFIV50D | 40 | PVC-U | L0 | FKM | 188,44 |
| 20 | TFIM20B | 15 | PP-H | L0 | EPDM | 155,77 |
| 25 | TFIM25B | 20 | PP-H | L0 | EPDM | 155,77 |
| 32 | TFIM32B | 25 | PP-H | L0 | EPDM | 199,98 |
| 40 | TFIM40B | 32 | PP-H | L0 | EPDM | 199,98 |
| 50 | TFIM50B | 40 | PP-H | L0 | EPDM | 228,82 |
| 20 | TFIM20D | 15 | PP-H | L0 | FKM | 155,77 |
| 25 | TFIM25D | 20 | PP-H | L0 | FKM | 155,77 |
| 32 | TFIM32D | 25 | PP-H | L0 | FKM | 199,98 |
| 40 | TFIM40D | 32 | PP-H | L0 | FKM | 199,98 |
| 50 | TFIM50D | 40 | PP-H | L0 | FKM | 228,82 |

Te

Otras conexiones disponibles bajo pedido



| Ref. | Material | Juntas | € |
|----------------|---------------|-------------------------|-----------------|
| HF6.004 | 0-400 mbarg | PVDF, PUR, FKM cerámica | 1.757,76 |
| HF6.010 | 0-1.000 mbarg | PVDF, PUR, FKM cerámica | 1.757,76 |
| HF6.100 | 0-10 barg | PVDF, PUR, FKM cerámica | 1.757,76 |
| HF6.160 | 0-16 barg | PVDF, PUR, FKM cerámica | 1.757,76 |

Transmisor de presión y nivel de profundidad..

| d x Rh | Ref. | DN | Material | Longitud sensor | Juntas | € |
|--------|-----------------|----|----------|-----------------|--------|---------------|
| 20 | TFIF20B | 15 | PVDF | L0 | EPDM | 251,90 |
| 25 | TFIF25B | 20 | PVDF | L0 | EPDM | 251,90 |
| 32 | TFIF32B | 25 | PVDF | L0 | EPDM | 269,24 |
| 40 | TFIF40B | 32 | PVDF | L0 | EPDM | 269,24 |
| 50 | TFIF50B | 40 | PVDF | L0 | EPDM | 303,83 |
| 20 | TFIF20D | 15 | PVDF | L0 | FKM | 251,90 |
| 25 | TFIF25D | 20 | PVDF | L0 | FKM | 251,90 |
| 32 | TFIF32D | 25 | PVDF | L0 | FKM | 269,24 |
| 40 | TFIF40D | 32 | PVDF | L0 | FKM | 269,24 |
| 50 | TFIF50D | 40 | PVDF | L0 | FKM | 303,83 |
| 20 | TFIV20BE | 15 | PVC-U+PE | L0 | EPDM | 134,62 |
| 25 | TFIV25BE | 20 | PVC-U+PE | L0 | EPDM | 134,62 |
| 32 | TFIV32BE | 25 | PVC-U+PE | L0 | EPDM | 169,19 |
| 40 | TFIV40BE | 32 | PVC-U+PE | L0 | EPDM | 169,19 |
| 50 | TFIV50BE | 40 | PVC-U+PE | L0 | EPDM | 188,44 |
| 20 | TFIV20DE | 15 | PVC-U+PE | L0 | FKM | 134,62 |
| 25 | TFIV25DE | 20 | PVC-U+PE | L0 | FKM | 134,62 |
| 32 | TFIV32DE | 25 | PVC-U+PE | L0 | FKM | 169,19 |
| 40 | TFIV40DE | 32 | PVC-U+PE | L0 | FKM | 169,19 |
| 50 | TFIV50DE | 40 | PVC-U+PE | L0 | FKM | 188,44 |
| ½" | TFFX20 | 15 | INOX316 | L0 | | 388,43 |
| ¾" | TFFX25 | 20 | INOX316 | L0 | | 388,43 |
| 1" | TFFX32 | 25 | INOX316 | L0 | | 388,43 |
| 1¼" | TFFX40 | 32 | INOX316 | L0 | | 421,13 |



INDUSTRIA

Medición Accesorios de instalación



| d | Ref. | DN | Material | Longitud sensor | € |
|---------|---------------|---------|-----------|-----------------|---------------|
| 50-225 | WAIXLO | 40-200 | Inox 316L | L0 | 207,70 |
| 250-600 | WAIXL1 | 225-600 | Inox 316L | L1 | 234,57 |

Inserto para tubos metálicos.



| Ref. | Cuerpo | DN | € |
|---------------|-----------|---------|---------------|
| WAIXHT | Inox 316L | 350-400 | 207,70 |

Adaptador para toma en carga [para sensores](#).



| d | Ref. | DN | Cuerpo | Longitud sensor | Juntas | € |
|-----|-------------------|-----|--------|-----------------|--------|---------------|
| 63 | SVIC063BVC | 50 | PVC-U | L0 | EPDM | 152,28 |
| 75 | SVIC075BVC | 65 | PVC-U | L0 | EPDM | 200,76 |
| 90 | SVIC090BVC | 80 | PVC-U | L0 | EPDM | 200,76 |
| 110 | SVIC110BVC | 100 | PVC-U | L0 | EPDM | 218,05 |
| 125 | SVIC125BVC | 110 | PVC-U | L1 | EPDM | 231,91 |
| 140 | SVIC140BVC | 125 | PVC-U | L1 | EPDM | 242,29 |
| 160 | SVIC160BVC | 150 | PVC-U | L1 | EPDM | 302,87 |
| 200 | SVIC200BVC | 180 | PVC-U | L1 | EPDM | 302,87 |
| 225 | SVIC225BVC | 200 | PVC-U | L1 | EPDM | 314,96 |
| 63 | SVIC063DVC | 50 | PVC-U | L0 | FKM | 315,09 |
| 75 | SVIC075DVC | 65 | PVC-U | L0 | FKM | 315,09 |
| 90 | SVIC090DVC | 80 | PVC-U | L0 | FKM | 315,09 |
| 110 | SVIC110DVC | 100 | PVC-U | L0 | FKM | 218,05 |
| 250 | SMIC250IVC | 225 | PP | L0 | NBR | 392,29 |
| 280 | SMIC280IVC | 250 | PP | L1 | NBR | 438,40 |
| 315 | SMIC315IVC | 300 | PP | L1 | NBR | 438,40 |

Collarín [para tubos de PVC-U y C-PVC](#).

Inserto en C-PVC.



| Ref. | Descripción | € |
|---------------|---|---------------|
| WAIXHP | Kit inserto adaptación Inox 316 para F3.20.X.01 | 489,16 |

Accesorio de instalación.

[para sensor F3.20.X.01](#).

De Ø 50 a Ø 225 (DN40 A DN200).

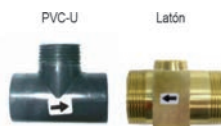

| d | Ref. | DN | Cuerpo | Conexion | € |
|-----|-----------------|----|--------|-----------|---------------|
| 20 | TMIV20MF | 15 | PVC-U | H encolar | 73,08 |
| 25 | TMIV25MF | 20 | PVC-U | H encolar | 76,89 |
| 32 | TMIV32MF | 25 | PVC-U | H encolar | 76,89 |
| 40 | TMIV40MF | 32 | PVC-U | H encolar | 80,77 |
| 50 | TMIV50MF | 40 | PVC-U | H encolar | 80,77 |
| 1¼" | TMFODN23 | 23 | Latón | M roscar | 313,46 |

Te. [para minisensor F3.10.H.XX](#).



| d | Ref. | DN | Cuerpo | Longitud sensor | Juntas | € |
|-----|-------------------|-----|--------|-----------------|--------|---------------|
| 63 | SVIC063BME | 50 | PVC-U | L0 | EPDM | 152,28 |
| 75 | SVIC075BME | 65 | PVC-U | L0 | EPDM | 200,76 |
| 90 | SVIC090BME | 80 | PVC-U | L0 | EPDM | 200,76 |
| 110 | SVIC110BME | 100 | PVC-U | L0 | EPDM | 218,05 |
| 125 | SVIC125BME | 110 | PVC-U | L1 | EPDM | 231,91 |
| 140 | SVIC140BME | 125 | PVC-U | L1 | EPDM | 242,29 |
| 160 | SVIC160BME | 150 | PVC-U | L1 | EPDM | 302,87 |
| 200 | SVIC200BME | 180 | PVC-U | L1 | EPDM | 302,87 |
| 225 | SVIC225BME | 200 | PVC-U | L1 | EPDM | 314,96 |
| 63 | SVIC063DME | 50 | PVC-U | L0 | FKM | 218,12 |
| 75 | SVIC075DME | 65 | PVC-U | L0 | FKM | 218,12 |
| 90 | SVIC090DME | 80 | PVC-U | L0 | FKM | 218,12 |
| 110 | SVIC110DME | 100 | PVC-U | L0 | FKM | 218,05 |
| 250 | SMIC250IME | 225 | PP | L0 | NBR | 392,29 |
| 280 | SMIC280IME | 250 | PP | L1 | NBR | 438,40 |
| 315 | SMIC315IME | 300 | PP | L1 | NBR | 438,40 |

Collarín [para tubos de PP-H y PE](#).

Inserto en C-PVC.



| d | Ref. | DN | Cuerpo | Longitud sensor | Juntas | € |
|-----|------------------|-----|--------|-----------------|--------|---------------|
| 63 | SVIF063BF | 50 | PVC-U | L0 | EPDM | 197,31 |
| 75 | SVIF075BF | 65 | PVC-U | L0 | EPDM | 261,31 |
| 90 | SVIF090BF | 80 | PVC-U | L0 | EPDM | 261,31 |
| 110 | SVIF110BF | 100 | PVC-U | L0 | EPDM | 283,83 |

Collarín **para tubos de PVDF**

Inserto en PVDF.



| Ref. | DN | Cuerpo | Longitud sensor | Tolerancia | € |
|-----------------|-----|------------|-----------------|------------|---------------|
| SZIC080I | 80 | Acero+inox | L0 | 88-104 | 248,09 |
| SZIC100I | 100 | Acero+inox | L0 | 112-126 | 255,75 |
| SZIC125I | 125 | Acero+inox | L0 | 140-154 | 326,89 |
| SZIC150I | 150 | Acero+inox | L0 | 168-184 | 346,10 |
| SZIC200I | 200 | Acero+inox | L1 | 218-244 | 361,53 |
| SZIC250I | 250 | Acero+inox | L1 | 272-295 | 382,63 |
| SZIC300I | 300 | Acero+inox | L1 | 322-354 | 405,73 |
| SZIC350I | 350 | Acero+inox | L1 | 356-414 | 440,34 |
| SZIC400I | 400 | Acero+inox | L1 | 406-472 | 499,96 |
| SZIC450I | 450 | Acero+inox | L1 | 457-534 | 607,65 |

Collarín metálico.

Junta en NBR. Inserto en C-PVC.



| d | Ref. | DN | Cuerpo | Longitud sensor | Juntas | € |
|-----|------------------|-----|--------|-----------------|--------|---------------|
| 63 | SVIF063DF | 50 | PVC-U | L0 | FKM | 197,31 |
| 75 | SVIF075DF | 65 | PVC-U | L0 | FKM | 261,31 |
| 90 | SVIF090DF | 80 | PVC-U | L0 | FKM | 261,31 |
| 110 | SVIF110DF | 100 | PVC-U | L0 | FKM | 283,83 |

Collarín **para tubos de PVDF.**

Inserto en PVDF.



| Ref. | DN | Cuerpo | Longitud sensor | Tolerancia | € |
|-------------------|-----|------------|-----------------|------------|---------------|
| SZIC080IHT | 80 | Acero+inox | L0 | 88-104 | 248,09 |
| SZIC100IHT | 100 | Acero+inox | L0 | 112-126 | 255,75 |
| SZIC125IHT | 125 | Acero+inox | L0 | 140-154 | 326,89 |
| SZIC150IHT | 150 | Acero+inox | L0 | 168-184 | 346,10 |
| SZIC200IHT | 200 | Acero+inox | L1 | 218-244 | 361,53 |
| SZIC250IHT | 250 | Acero+inox | L1 | 272-295 | 382,63 |
| SZIC300IHT | 300 | Acero+inox | L1 | 322-354 | 405,73 |
| SZIC350IHT | 350 | Acero+inox | L1 | 356-414 | 440,34 |
| SZIC400IHT | 400 | Acero+inox | L1 | 406-472 | 499,96 |
| SZIC450IHT | 450 | Acero+inox | L1 | 457-534 | 607,65 |

Collarín metálico. **con toma en carga.**



Salida 2" rosca hembra. Junta en NBR.

Longitud L0 para diámetros de ø 20-110 mm. Longitud L1 para diámetros de 125-450 mm.



Adaptadores para instalación en línea, sumergibles e instalación Wet-Tap.

| | Ref. | Cuerpo | Descripción | Para electrodos | € |
|---|------------------|------------|--|---|---------------|
|  | EG12SS | Inox | Prensaestopas de electrodos macho ½" | C300 | 238,38 |
| | TCONIV32E | PVC-U | Accesorio en T ø 32 DN25 | C150-200 | 138,50 |
| | TCONIV40E | PVC-U | Accesorio en T ø 40 DN32 | C150-200 | 145,43 |
| | TCONIV50E | PVC-U | Accesorio en T ø 50 DN40 | C150-200 | 152,71 |
|  | TCONIC32E | C-PVC | Accesorio en T ø 32 DN25 | C150-200 | 153,76 |
| | TCONIC40E | C-PVC | Accesorio en T ø 40 DN32 | C150-200 | 161,47 |
| | TCONIC50E | C-PVC | Accesorio en T ø 50 DN40 | C150-200 | 169,52 |
| | TPHIV32E | PVC-U | Accesorio en T ø 32 DN25 | PH/ORP200 (NO p/PH223CD, ORP223CD) | 138,47 |
| | TPHIV40E | PVC-U | Accesorio en T ø 40 DN32 | PH/ORP200 (NO p/PH223CD, ORP223CD) | 108,77 |
| | TPHIV50E | PVC-U | Accesorio en T ø 50 DN40 | PH/ORP200 (NO p/PH223CD, ORP223CD) | 152,68 |
|  | TPHIC32E | C-PVC | Accesorio en T ø 32 DN25 | PH/ORP200 (NO p/PH223CD, ORP223CD) | 123,00 |
| | TPHIC40E | C-PVC | Accesorio en T ø 40 DN32 | PH/ORP200 (NO p/PH223CD, ORP223CD) | 129,18 |
| | TPHIC50E | C-PVC | Accesorio en T ø 50 DN40 | PH/ORP200 (NO p/PH223CD, ORP223CD) | 135,60 |
| | TPHIC32C | C-PVC | Accesorio en T ø 32 DN25 | PH660-ORP660 | 153,78 |
| | TPHIC40C | C-PVC | Accesorio en T ø 40 DN32 | PH660-ORP660 | 159,94 |
| | TPHIC50C | C-PVC | Accesorio en T ø 50 DN40 | PH660-ORP660 | 166,38 |
|  | EG66P | C-PVC | Prensaestopas de electrodos macho ¾" | PH660-ORP660 | 88,34 |
|  | MK660 | C-PVC | Kit de instalación (adaptador + tapón amarillo) para accesorios FLS hasta DN100 (4") | PH660-ORP660 | 45,44 |
|  | MK150200 | C-PVC | Kit de instalación (EG50P + adaptador + tapón amarillo) para accesorios FLS hasta DN100 (4") | PH200C, ORP200C, C150.1, C150.01TC | 95,91 |
|  | GEG135SE | PP | Prensaestopas para electrodo PG13.5 con protección de cabeza de electrodo 1¼" G.M. | PH430CD, ORP430CD, PH435CD | 370,13 |
|  | F3.SP2.4 | PVC-U | Tapón de electrodo color amarillo para accesorios FLS hasta DN100 (4") | PH223CD, ORP223CD | 29,75 |
|  | GEG135 | PVC-U | Prensaestopas para electrodo PG13.5 o cuerpo de 12 mm y 1½" G.M. | PH-ORP400 | 35,36 |
|  | EG50P | PP | Prensaestopas de electrodo macho ½" | PH-ORP200 (NO para PH223CD, ORP223CD), C150-200, T970278, T970196 | 47,96 |
|  | EG75P | PP | Prensaestopas de electrodo macho ¾" | PH-ORP200 (NO para PH223CD, ORP223CD), 0-200, T970278, T970196 | 47,96 |
| | EG135FS | PVDF / FKM | Prensaestopas corto p/electrodo PG13.5 ½" PH-ORP430, PH435CD | | 97,20 |
| | EG135FL | PVDF / FKM | Prensaestopas largo p/electrodo PG13.5 ½" PH-ORP430, PH435CD | | 106,88 |

Adaptadores para instalación en inmersión.

| | Ref. | Cuerpo | Descripción | Para electrodos | € |
|---|------------------|--------|---|--|--------------|
|  | MIFV20X05 | PVC-U | Doble toma 20 x 1/2" (tubería suministrada por el cliente) | PH200C-ORP200C (con EG50P), PH222CD ORP222CD (con CN653), (GEG135), PH650 ORP650 (CON CN653), C150-200 (CON EG50P) | 5,10 |
|  | MIMC20X05 | C-PVC | Doble toma 20 x 1/2" (tubería suministrada por el cliente) | PH200C-ORP200C (con EG50P), PH222CD ORP222CD (con CN653), (GEG135), PH650 ORP650 (CON CN653), C150-200 (CON EG50P) | 22,71 |

Adaptadores para toma en carga u horizontal.

| | Ref. | Cuerpo | Descripción | Para electrodos | € |
|---|-----------------|----------|---|-----------------|-----------------|
|  | WT675 | C-PVC | Prensaestopa de electrodo para instalación con toma en carga: inserción máxima 300 mm (12") | PH655-ORP655 | 1.081,43 |
|  | WT675TC1 | C-PVC/SS | Prensaestopa de electrodo para instalación con toma en carga: inserción máxima 300 mm (12") | PH655-ORP655 | 1.614,92 |

Recambios para monitor M9.00.

| Ref. | Descripción | € |
|-----------------|---|---------------|
| M9.SP4.1 | Prensaestopas de cable completo PG11 (2 juntas tóricas y capuchón) | 10,83 |
| M9.LN1 | Tuerca de bloqueo de plástico para M9.02 | 54,57 |
| M9.SN1 | 2 Tornillos de fijación de plástico para instalación en panel de todos los monitores FLS (excepto para M9.02) | 54,57 |
| M9.SP7 | Recambio de batería 3,6 voltios (2,4 Ah). Batería de litio cloruro de tionilo (sólo para M9.20) | 189,81 |
| M9.KUSB | Cable USB para productos FLS, 1,5 metros de longitud | 28,03 |

Recambios para sensor de caudal de paletas F3.00.

| Ref. | Descripción | € |
|-----------------|---|---------------|
| F3.SP1 | Enchufe de cable de 4 clavijas según DIN 43650 | 61,89 |
| F3.SP2.1 | Tapón negro para sensor versión HALL | 29,75 |
| F3.SP2.2 | Tapón rojo para sensor versión COIL | 29,75 |
| F3.SP2.4 | Tapón amarillo para sensor versión PLC | 29,75 |
| F3.SP2.6 | Tapón en inox AISI 316 para sensor en inox versión HALL y COIL | 66,88 |
| F3.SP3.1 | Juntas tóricas para cuerpo del sensor en EPDM | 5,01 |
| F3.SP3.2 | Juntas tóricas para cuerpo del sensor en FKM | 7,45 |
| F3.SP4.2 | Kit rotor. Rotor en ECTFE (Halar®) con cojinetes y eje en cerámica mecanizada | 250,05 |
| F3.SP4.3 | Kit rotor. Rotor en ECTFE (Halar®) con eje en acero inox | 153,49 |
| F3.SP5.1 | Toma de sensor en C-PVC | 69,32 |
| F3.SP5.2 | Toma de sensor en PVDF | 98,35 |
| F3.SP5.3 | Toma de sensor en acero inox | 37,13 |
| F3.SP6 | Cable eléctrico (precio por metro), 22AWG, 3 cond. | 5,56 |

Recambios para sensor de caudal de paletas para altas presiones F3.20

| Ref. | Descripción | € |
|-----------------|---|---------------|
| F3.SP4.3 | Kit rotor. Rotor en ECTFE (Halar®) con eje en acero inox | 153,49 |
| F3.SP8 | Kit de juntas y tornillos. Tornillos en acero inox y junta en grafito | 64,53 |

Recambios para transmisor de caudal de paletas F6.30.

| Ref. | Descripción | € |
|--------------------|--|---------------|
| F6.KC1 | Kit de montaje compacto. Adaptador de plástico con capuchón compacto y tuerca de bloqueo | 158,60 |
| M9.SP4.1 | Prensaestopas de cable completo PG11 (2 juntas tóricas y capuchón) | 10,83 |
| F3.SP3.1 | Juntas tóricas para cuerpo del sensor en EPDM | 5,01 |
| F3.SP3.2 | Juntas tóricas para cuerpo del sensor en FKM | 7,45 |
| F6.30.SP1.S | Dispositivo electrónico con salida 4-20 mA y salida de impulsos de frecuencia/volumen para sensor de caudal de paletas | 771,95 |
| M9.KUSB | Cable USB para productos FLS, 1,5 metros de longitud | 28,03 |

Recambios para minisensor de caudal de paletas F3.10.

| Ref. | Descripción | € |
|-----------------|--|--------------|
| F3.SP2.7 | Tapa de sensor gris | 11,69 |
| F3.SP3.3 | Juntas tóricas para cuerpo del sensor en EPDM | 5,10 |
| F3.SP3.4 | Juntas tóricas para cuerpo del sensor en FKM | 7,55 |
| F3.SP11 | Kit rotor. Rotor de PVC con eje en AISI 316L | 78,06 |
| M9.KUSB | Cable USB para productos FLS, 1,5 metros de longitud | 28,03 |

Recambios para sensor de caudal de paletas interruptor de caudal (Batch Controller) F3.05.

| Ref. | Descripción | € |
|-----------------|---|---------------|
| F3.SP1 | Enchufe de cable de 4 clavijas según DIN 43650 | 61,89 |
| F3.SP2.1 | Tapón negro para sensor versión HALL | 29,75 |
| F3.SP3.1 | Juntas tóricas para cuerpo del sensor en EPDM | 5,01 |
| F3.SP3.2 | Juntas tóricas para cuerpo del sensor en FKM | 7,45 |
| F3.SP4.2 | Kit rotor. Rotor en ECTFE (Halar®) con cojinetes y eje en cerámica mecanizada | 250,05 |
| F3.SP5.1 | Toma de sensor en C-PVC | 69,32 |
| F3.SP5.2 | Toma de sensor en PVDF | 98,35 |
| F3.SP5.3 | Toma de sensor en acero inoxidable | 37,13 |



Recambios para sensor de caudal electromagnético para tomas en carga F6.61.

| Ref. | Descripción | € |
|---------------------|--|-----------------|
| F6.KC1 | Kit de montaje compacto. Adaptador de plástico con capuchón compacto y tuerca de bloqueo | 158,60 |
| M9.SP4.1 | Prensaestopas de cable completo PG11 (2 juntas tóricas y capuchón) | 10,83 |
| F1.SP3 | Válvula de aislamiento esférica de latón 2" | 197,26 |
| F1.SP5 | Válvula de aislamiento esférica de latón 1½" | 197,26 |
| F1.SP6 | Reducción roscada macho-hembra 2"-1 ¼" en acero cincado | 20,76 |
| F1.SP7 | Reducción roscada macho(NPT)-hembra 2"-1¼" en acero cincado | 20,76 |
| F6.60M.SP1.S | Dispositivo electrónico de medición magnética con salida 4-20 mA y salida de impulsos de frecuencia/volumen. | 1.467,63 |
| F3.61M.SP01 | Sensor de caudal de medidor electromagnético para inserción con toma en carga. Cuerpo en inox 304/PVDF | 3.930,19 |
| M9.KUSB | Cable USB para productos FLS, 1,5 metros de longitud | 28,03 |





Recambios para sensor de caudal electromagnético F6.60 R

| Ref. | Descripción | € |
|--------------------|---|-----------------|
| F6.KC1 | Kit de montaje compacto. Adaptador de plástico con capuchón compacto y tuerca de bloqueo | 158,60 |
| M9.SP4.1 | Prensaestopas de cable completo PG11 (2 juntas tóricas y capuchón) | 10,83 |
| F3.SP3.1 | Juntas tóricas para cuerpo del sensor en EPDM | 5,01 |
| F3.SP3.2 | Juntas tóricas para cuerpo del sensor en FKM | 7,45 |
| F6.60.SP1.S | Dispositivo electrónico de medición magnética con salida 4-20 mA y salida de impulsos de frec./volum. para sensor bidireccional | 1.467,63 |
| F3.60M.SP09 | Sensor de caudal bidireccional p/medidor electromagn. Cuerpo en inox 316L/PVDF. Juntas tóricas en EPDM. Long. L0 | 1.046,62 |
| F3.60M.SP10 | Sensor de caudal bidireccional p/medidor electromagn. Cuerpo en inox 316L/PVDF. Juntas tóricas en FKM. Long. L0 | 1.328,56 |
| F3.60M.SP11 | Sensor de caudal bidireccional p/medidor electromagn. Cuerpo en inox 316L/PVDF. Juntas tóricas en EPDM. Long. L1 | 1.416,16 |
| F3.60M.SP12 | Sensor de caudal bidireccional p/medidor electromagn. Cuerpo en inox 316L/PVDF. Juntas tóricas en FKM. Long. L1 | 1.416,16 |
| F3.60M.SP13 | Sensor de caudal bidireccional p/medidor electromagn. Cuerpo en CuNi/PVDF. Juntas tóricas en EPDM. Long. L0 | 1.532,98 |
| F3.60M.SP14 | Sensor de caudal bidireccional p/medidor electromagn. Cuerpo en CuNi/PVDF. Juntas tóricas en FKM. Long. L0 | 1.532,98 |
| F3.60M.SP15 | Sensor de caudal bidireccional p/medidor electromagn. Cuerpo en CuNi/PVDF. Juntas tóricas en EPDM. Long. L1 | 1.620,57 |
| F3.60M.SP16 | Sensor de caudal bidireccional p/medidor electromagn. Cuerpo en CuNi/PVDF. Juntas tóricas en FKM. Long. L1 | 1.620,57 |
| F3.60M.SP17 | Sensor de caudal bidireccional p/medidor electromagn. Cuerpo en inox316L/PEEK. Juntas tóricas en FKM. Long. L0 | 1.532,98 |
| F3.60M.SP18 | Sensor de caudal bidireccional p/medidor electromagn. Cuerpo en inox316L/PEEK. Juntas tóricas en FKM. Long. L1 | 1.620,57 |
| M9.KUSB | Cable USB para productos FLS, 1,5 metros de longitud | 28,03 |



Recambios para monitor M9.00.

| Ref. | Descripción | € |
|---|--|---------------|
|  F6.KC1 | Kit de montaje compacto. Adaptador de plástico con capuchón compacto y tuerca de bloqueo (sólo para monitor M9.02) | 158,60 |
|  M9.KW1 | Kit de montaje mural. Caja plástica de 144 x 144 mm para instalación mural de todos los monitores de montaje en panel | 232,09 |
| M9.KW2 | Kit de montaje mural con alimentación. Caja plástica de 144 x 144 mm para instalación mural de todos los monitores de montaje en panel y fuente de alimentación de 110/230 VAC a 24DC incluida | 451,26 |
| M9.KUSB | Cable USB para productos FLS 1,5 metros de longitud | 28,03 |

Recambios para electrodos de pH/ORP

| | Ref. | Descripción | € |
|---|-----------------|--|---------------|
|  | CN653 | Montaje cable universal de 5 metros. Para electrodos: PH222CD, OPR222CD, ORP223CD, PH-ORP600 | 314,87 |
| | CN65310M | Montaje cable universal de 10 metros. Para electrodos: PH222CD, OPR222CD, ORP223CD, PH-ORP600 | 389,12 |
| | CN65315M | Montaje cable universal de 15 metros. Para electrodos: PH222CD, OPR222CD, ORP223CD, PH-ORP600 | 463,34 |
|  | CN653TC1 | Montaje de cable sumergible de 5 metros con compensación de temperatura. Para electrodos PH222CD, PH223CD, PH650CD, PH650CDHF, PH650CDDA, PH650CDLC | 694,91 |
|  | CE5S7 | Montaje cable de 5 metros. Para electrodos: PH435CD, PH430CD, ORP430CD | 237,62 |
| | CE10S7 | Montaje cable de 10 metros. Para electrodos: PH435CD, PH430CD, ORP430CD | 282,20 |
| | CE15S7 | Montaje cable de 15 metros. Para electrodos: PH435CD, PH430CD, ORP430CD | 326,75 |
|  | B104 | Solución tampón pH 4,01 | 80,18 |
| | B107 | Solución tampón pH 7,00 | 80,18 |
| | B110 | Solución tampón pH 10,00 | 80,18 |
| | B3KCL | Solución tampón pH solución 3KCl | 95,74 |
| | B475 | Solución tampón ORP 475 mV | 80,18 |

Recambios para sensores de conductividad.

| | Ref. | Descripción | € |
|---|----------------|--|---------------|
|  | T970278 | Sensor de temperatura PT100 con dos cables (5 metros) y cuerpo epóxico ** | 222,77 |
| | T970196 | Sensor de temperatura PT100 con dos cables (5 metros) y cuerpo epóxico ** (sin metal ni contacto) | 564,35 |
|  | B0018 | Solución tampón de conductividad para calibración de baja conductividad (18 microsiemens) | 133,66 |
| | B1417 | Solución tampón de conductividad para calibración de conductividad (1.417 microsiemens) | 210,66 |

** +5 € / metro cable

Tubo y accesorios
Válvulas manuales
Válvulas actuadas
Válvulas de control de presión



0805

Sistema PP-H Socket

INDUSTRIA



Más información



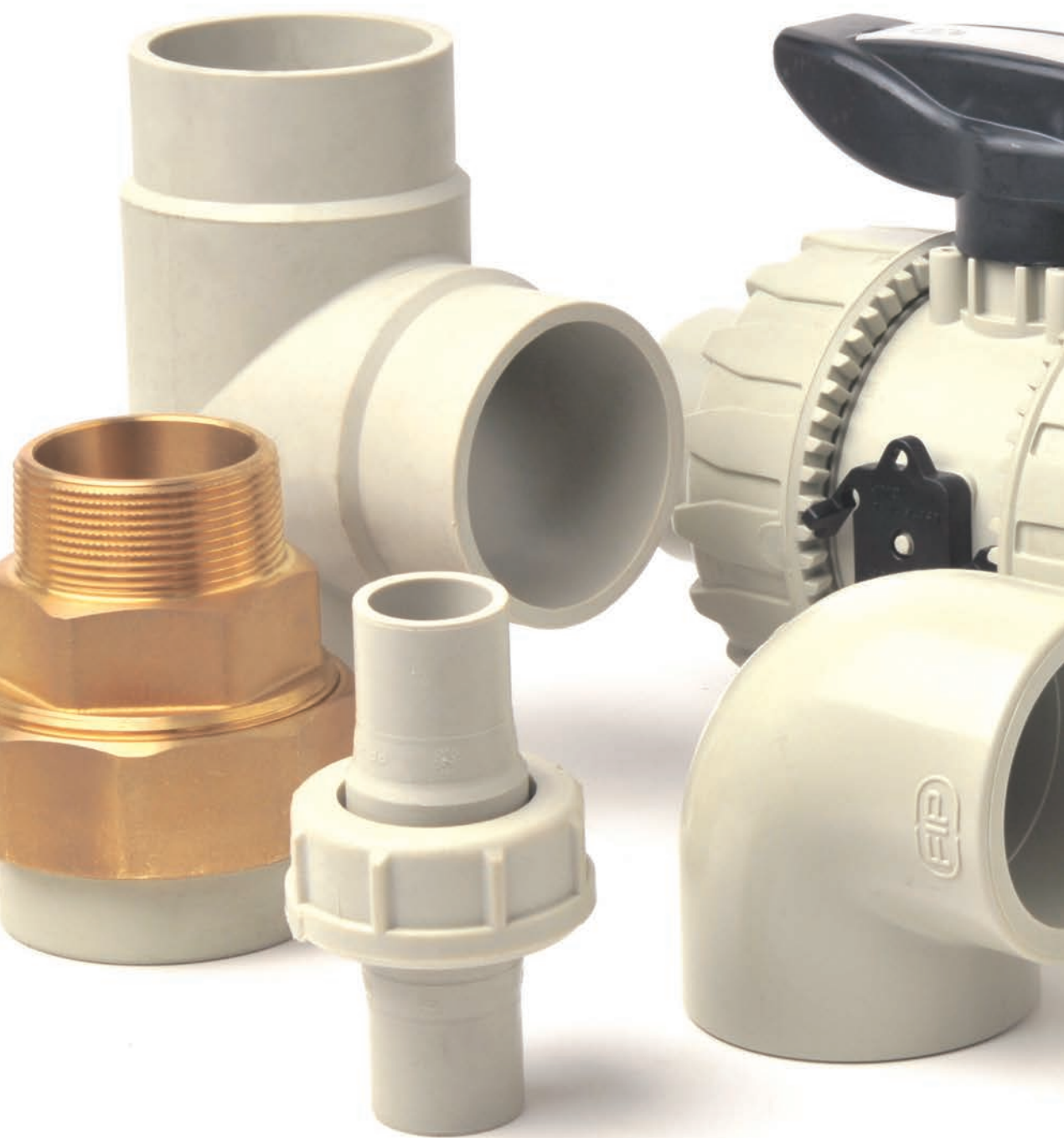

Sistema PP-H Socket

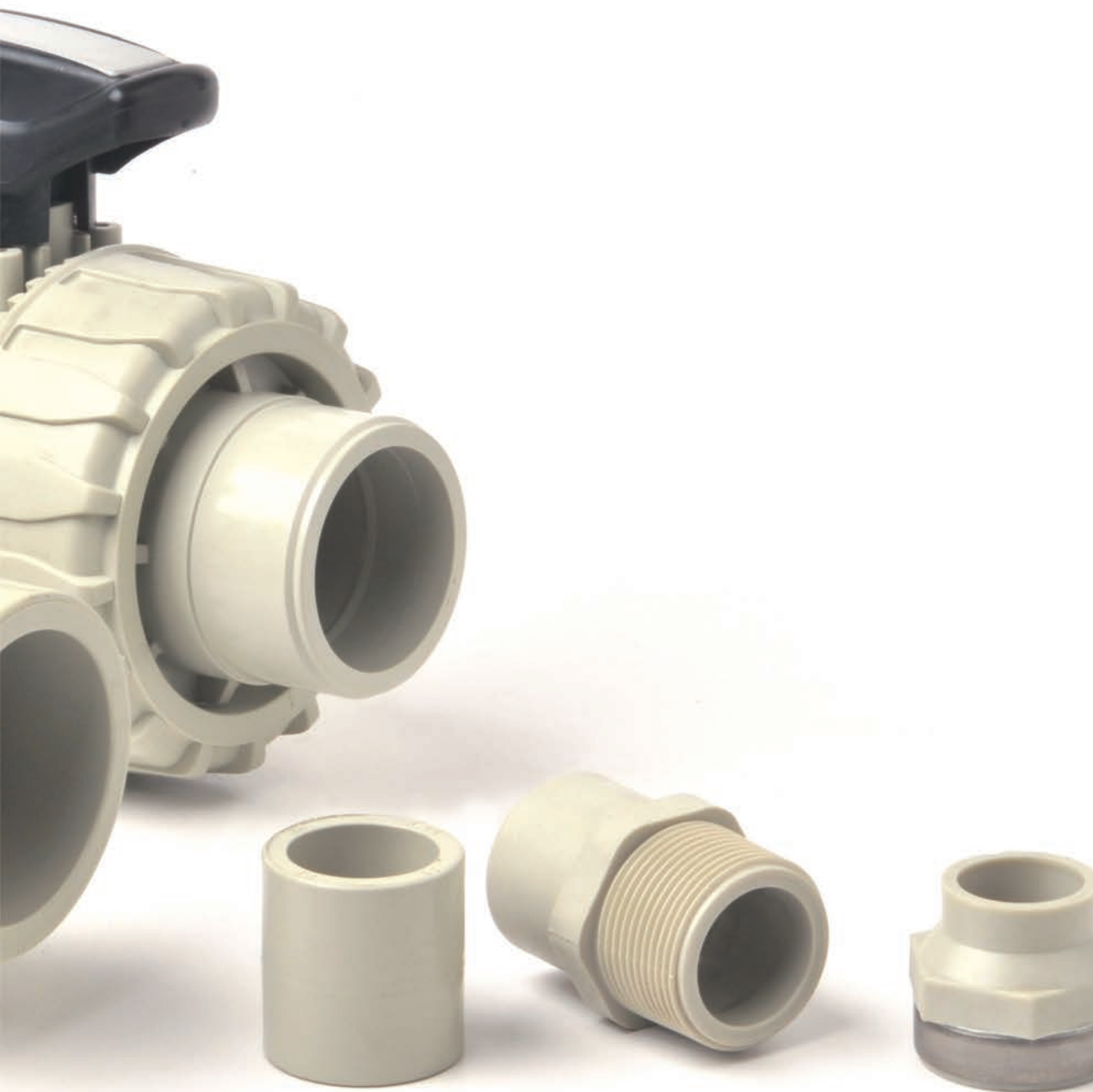



INDUSTRIA

Sistema PP-H Socket

Tubo



| d | Ref. | Espesor | Longitud barras | €/m. |
|-----|------------|---------|-----------------|----------|
| 25 | PIPEM17025 | 1,8 | 5 m. | 1,56 |
| 32 | PIPEM17032 | 1,9 | 5 m. | 1,96 |
| 40 | PIPEM17040 | 2,3 | 5 m. | 3,14 |
| 50 | PIPEM17050 | 2,9 | 5 m. | 4,76 |
| 63 | PIPEM17063 | 3,6 | 5 m. | 7,40 |
| 75 | PIPEM17075 | 4,3 | 5 m. | 10,49 |
| 90 | PIPEM17090 | 5,1 | 5 m. | 14,92 |
| 110 | PIPEM17110 | 6,3 | 5 m. | 22,32 |
| 125 | PIPEM17125 | 7,1 | 5 m. | 28,60 |
| 140 | PIPEM17140 | 8,0 | 5 m. | 35,90 |
| 160 | PIPEM17160 | 9,1 | 5 m. | 46,74 |
| 180 | PIPEM17180 | 10,2 | 5 m. | 73,50 |
| 200 | PIPEM17200 | 11,4 | 5 m. | 87,79 |
| 225 | PIPEM17225 | 12,8 | 5 m. | 114,75 |
| 250 | PIPEM17250 | 14,2 | 5 m. | 144,01 |
| 280 | PIPEM17280 | 15,9 | 5 m. | 176,58 |
| 315 | PIPEM17315 | 17,9 | 5 m. | 224,49 |
| 355 | PIPEM17355 | 20,1 | 5 m. | 334,25 |
| 355 | PIPEM17355 | 20,1 | 5 m. | 334,25 |
| 400 | PIPEM17400 | 22,7 | 5 m. | 421,17 |
| 400 | PIPEM17400 | 22,7 | 5 m. | 421,17 |
| 450 | PIPEM17450 | 25,5 | 5 m. | 585,28 |
| 500 | PIPEM17500 | 28,4 | 5 m. | 723,87 |
| 560 | PIPEM17560 | 31,7 | 5 m. | 1.044,64 |
| 630 | PIPEM17630 | 35,7 | 5 m. | 1.323,52 |
| 710 | PIPEM17710 | 40,2 | 5 m. | 1.678,53 |
| 800 | PIPEM17800 | 45,3 | 5 m. | 2.139,41 |

Tubo PP-H (100) SDR17,6 (PN6).

Para soldar socket y a testa. Para otros diámetros consultar disponibilidad.

| d | Ref. | Espesor | Longitud barras | €/m. |
|-----|------------|---------|-----------------|----------|
| 20 | PIPEM11020 | 1,9 | 5 m. | 1,25 |
| 25 | PIPEM11025 | 2,3 | 5 m. | 1,93 |
| 32 | PIPEM11032 | 2,9 | 5 m. | 2,99 |
| 40 | PIPEM11040 | 3,7 | 5 m. | 4,70 |
| 50 | PIPEM11050 | 4,6 | 5 m. | 7,16 |
| 63 | PIPEM11063 | 5,8 | 5 m. | 11,33 |
| 75 | PIPEM11075 | 6,8 | 5 m. | 15,69 |
| 90 | PIPEM11090 | 8,2 | 5 m. | 22,76 |
| 110 | PIPEM11110 | 10,0 | 5 m. | 33,75 |
| 125 | PIPEM11125 | 11,4 | 5 m. | 50,29 |
| 140 | PIPEM11140 | 12,7 | 5 m. | 62,61 |
| 160 | PIPEM11160 | 14,6 | 5 m. | 71,63 |
| 180 | PIPEM11180 | 16,4 | 5 m. | 112,91 |
| 200 | PIPEM11200 | 18,2 | 5 m. | 136,99 |
| 225 | PIPEM11225 | 20,5 | 5 m. | 174,07 |
| 250 | PIPEM11250 | 22,7 | 5 m. | 221,48 |
| 280 | PIPEM11280 | 25,4 | 5 m. | 267,14 |
| 315 | PIPEM11315 | 28,6 | 5 m. | 344,71 |
| 355 | PIPEM11355 | 32,3 | 5 m. | 522,85 |
| 400 | PIPEM11400 | 39,5 | 5 m. | 659,49 |
| 450 | PIPEM11450 | 40,9 | 5 m. | 914,30 |
| 500 | PIPEM11500 | 45,9 | 5 m. | 1.127,77 |

Tubo PP-H (100) SDR11 (PN10).

Para soldar socket y a testa. Para otros diámetros consultar disponibilidad.

**TIM**

| d | Ref. | Pack | € |
|-----|---------------|------|--------------|
| 20 | TIM020 | 10 | 4,20 |
| 25 | TIM025 | 10 | 4,65 |
| 32 | TIM032 | 10 | 5,42 |
| 40 | TIM040 | 5 | 6,94 |
| 50 | TIM050 | 5 | 12,41 |
| 63 | TIM063 | 2 | 15,84 |
| 75 | TIM075 | - | 36,76 |
| 90 | TIM090 | - | 59,37 |
| 110 | TIM110 | - | 75,34 |

Te a 90°.

H-H para fusión socket.**GIM**

| d | Ref. | Pack | € |
|-----|---------------|------|--------------|
| 20 | GIM020 | 10 | 3,56 |
| 25 | GIM025 | 10 | 4,20 |
| 32 | GIM032 | 10 | 5,07 |
| 40 | GIM040 | 5 | 6,47 |
| 50 | GIM050 | 5 | 11,91 |
| 63 | GIM063 | 2 | 15,48 |
| 75 | GIM075 | - | 32,17 |
| 90 | GIM090 | - | 39,59 |
| 110 | GIM110 | - | 59,37 |

Codo 90°.

H-H para fusión socket.**HIM**

| d | Ref. | Pack | € |
|-----|---------------|------|--------------|
| 20 | HIM020 | 10 | 5,07 |
| 25 | HIM025 | 10 | 5,42 |
| 32 | HIM032 | 10 | 6,68 |
| 40 | HIM040 | 5 | 9,24 |
| 50 | HIM050 | 5 | 11,91 |
| 63 | HIM063 | 2 | 15,84 |
| 75 | HIM075 | - | 36,76 |
| 90 | HIM090 | - | 50,74 |
| 110 | HIM110 | - | 74,21 |

Codo 45°.

H-H para fusión socket.**MIM**

| d | Ref. | Pack | € |
|-----|---------------|------|--------------|
| 20 | MIM020 | 10 | 2,45 |
| 25 | MIM025 | 10 | 2,80 |
| 32 | MIM032 | 10 | 3,22 |
| 40 | MIM040 | 5 | 3,88 |
| 50 | MIM050 | 5 | 7,45 |
| 63 | MIM063 | 2 | 11,30 |
| 75 | MIM075 | - | 15,74 |
| 90 | MIM090 | - | 22,47 |
| 110 | MIM110 | - | 35,29 |

Manguito.

H-H para fusión socket.



MIMM

| d x Rh | Ref. | Pack | € |
|-------------|------------|------|-------|
| 20 x 1/2" | MIMM020012 | 10 | 4,78 |
| 25 x 3/4" | MIMM025034 | 10 | 6,08 |
| 32 x 1" | MIMM032100 | 10 | 7,71 |
| 40 x 1 1/4" | MIMM040114 | 5 | 9,24 |
| 50 x 1 1/2" | MIMM050112 | 5 | 15,21 |
| 63 x 2" | MIMM063200 | 2 | 19,25 |

Manguito mixto reforzado.
H-H para fusión socket-rosca.



QRNM

| d | Ref. | Pack | € |
|-----|---------|------|-------|
| 20 | QRNM020 | 10 | 5,96 |
| 25 | QRNM025 | 10 | 6,23 |
| 32 | QRNM032 | 10 | 6,76 |
| 40 | QRNM040 | 5 | 8,32 |
| 50 | QRNM050 | 5 | 9,72 |
| 63 | QRNM063 | 2 | 12,07 |
| 75 | QRNM075 | - | 26,12 |
| 90 | QRNM090 | - | 41,25 |
| 110 | QRNM110 | - | 57,10 |

Manguito portabridas estriado.
H para fusión socket.



ODC

| d | Ref. | DN | € |
|-----|--------|-----|-------|
| 20 | ODC020 | 15 | 7,31 |
| 25 | ODC025 | 20 | 8,70 |
| 32 | ODC032 | 25 | 10,09 |
| 40 | ODC040 | 32 | 12,34 |
| 50 | ODC050 | 40 | 15,94 |
| 63 | ODC063 | 50 | 17,75 |
| 75 | ODC075 | 65 | 26,42 |
| 90 | ODC090 | 80 | 29,20 |
| 110 | ODC110 | 100 | 40,10 |

Brida loca.
UNI 2223 PN10.
En C-PVC para manguito portabridas.
Descuento de la familia C-PVC



RIM

| dm x dh | Ref. | Pack | € |
|----------|-----------|------|-------|
| 25 x 20 | RIM025020 | 10 | 3,46 |
| 32 x 20 | RIM032020 | 10 | 4,20 |
| 32 x 25 | RIM032025 | 10 | 4,20 |
| 40 x 25 | RIM040025 | 10 | 5,00 |
| 40 x 32 | RIM040032 | 10 | 5,00 |
| 50 x 32 | RIM050032 | 5 | 6,47 |
| 50 x 40 | RIM050040 | 5 | 6,31 |
| 63 x 32 | RIM063032 | 5 | 7,53 |
| 63 x 50 | RIM063050 | 5 | 7,71 |
| 75 x 50 | RIM075050 | - | 13,81 |
| 75 x 63 | RIM075063 | - | 13,81 |
| 90 x 63 | RIM090063 | - | 19,25 |
| 90 x 75 | RIM090075 | - | 18,93 |
| 110 x 63 | RIM110063 | - | 26,41 |
| 110 x 90 | RIM110090 | - | 27,25 |

Reducción cónica.
M-H para fusión socket.



GRAM

| d | Ref. | Pack | € |
|--------|---------|------|-------|
| 3/4" | GRAM034 | 10 | 7,45 |
| 1" | GRAM100 | 10 | 8,09 |
| 1 1/4" | GRAM114 | 10 | 10,08 |
| 1 1/2" | GRAM112 | 5 | 11,67 |
| 3" | GRAM300 | - | 49,52 |

Manguito portabridas estriado ANSI 150 lbs.
H para fusión socket.



ODB

| d | Ref. | DN | € |
|-------|--------|-----|-------|
| 20 | ODB020 | 15 | 8,85 |
| 25 | ODB025 | 20 | 9,72 |
| 32 | ODB032 | 25 | 12,51 |
| 40 | ODB040 | 32 | 15,18 |
| 50 | ODB050 | 40 | 17,75 |
| 63 | ODB063 | 50 | 22,08 |
| 75 | ODB075 | 65 | 24,40 |
| 90 | ODB090 | 80 | 29,06 |
| **125 | ODB125 | 100 | 35,07 |

Brida loca.
En PP con alma de acero.
PN10. Para manguito portabridas.
Versión ANSI 150 lbs (ver OAB página 320)

Más diámetros en página 320
** Para usar con portabridas QRNM110



CIM

| d | Ref. | Pack | € |
|-----|--------|------|-------|
| 20 | CIM020 | 10 | 3,22 |
| 25 | CIM025 | 10 | 3,22 |
| 32 | CIM032 | 10 | 4,02 |
| 40 | CIM040 | 5 | 4,73 |
| 50 | CIM050 | 5 | 6,76 |
| 63 | CIM063 | 2 | 8,74 |
| 75 | CIM075 | - | 16,01 |
| 90 | CIM090 | - | 18,54 |
| 110 | CIM110 | - | 25,65 |

Tapón.

H para fusión socket.



AIM

| d x P1 x P2 | Ref. | Pack | € |
|--------------|--------------|------|-------|
| 20 x 22 x 20 | AIM020022020 | 10 | 3,65 |
| 25 x 27 x 25 | AIM025027025 | 10 | 4,65 |
| 32 x 32 x 30 | AIM032032030 | 10 | 5,65 |
| 40 x 42 x 40 | AIM040042040 | 5 | 9,80 |
| 50 x 52 x 50 | AIM050052050 | 5 | 12,21 |
| 63 x 64 x 60 | AIM063064060 | 5 | 13,58 |

Espiga.

M para fusión socket.



BIGM

| d | Ref. | Pack | € | |
|----|----------|------|-------|-------|
| | | | EPDM | FKM |
| 20 | BIGM020E | 10 | 14,00 | 16,21 |
| 25 | BIGM025E | 10 | 15,48 | 17,75 |
| 32 | BIGM032E | 10 | 17,75 | 21,02 |
| 40 | BIGM040E | 2 | 22,47 | 28,15 |
| 50 | BIGM050E | 2 | 32,12 | 39,59 |
| 63 | BIGM063E | 2 | 45,79 | 54,56 |

Unión 3 piezas.

H-H para fusión socket.

Código en FKM termina en "F" en lugar de "E"



BIFGM

| d x Rh | Ref. | Pack | € | |
|-------------|--------------|------|-------|-------|
| | | | EPDM | FKM |
| 20 x 1/2" | BIFGM020012E | 10 | 21,02 | 24,62 |
| 25 x 3/4" | BIFGM025034E | 10 | 23,13 | 26,49 |
| 32 x 1" | BIFGM032100E | 10 | 24,22 | 28,94 |
| 40 x 1 1/4" | BIFGM040114E | 2 | 37,82 | 48,07 |
| 50 x 1 1/2" | BIFGM050112E | 2 | 55,30 | 68,62 |
| 63 x 2" | BIFGM063200E | 2 | 63,52 | 75,34 |

Unión 3 piezas.

H-H para fusión socket-rosocar.

Código en FKM termina en "F" en lugar de "E"



BIFOM

| d x Rh | Ref. | Pack | € |
|-------------|--------------|------|-------|
| 20 x 1/2" | BIFOM020012E | 40 | 24,64 |
| 25 x 3/4" | BIFOM025034E | 16 | 30,02 |
| 32 x 1" | BIFOM032100E | 10 | 37,55 |
| 40 x 1 1/4" | BIFOM040114E | 8 | 46,32 |
| 50 x 1 1/2" | BIFOM050112E | 4 | 59,79 |
| 63 x 2" | BIFOM063200E | - | 77,64 |

Unión 3 piezas mixto PP-H / latón.

Junta en EPDM.

H-H para fusión socket-rosocar latón.



BIROM

| d x Rm | Ref. | Pack | € |
|-------------|--------------|------|-------|
| 20 x 1/2" | BIROM020012E | 35 | 27,73 |
| 25 x 3/4" | BIROM025034E | 15 | 33,52 |
| 32 x 1" | BIROM032100E | 8 | 43,04 |
| 40 x 1 1/4" | BIROM040114E | 8 | 56,80 |
| 50 x 1 1/2" | BIROM050112E | 4 | 69,96 |
| 63 x 2" | BIROM063200E | - | 90,22 |

Unión 3 piezas mixto PP-H / latón.

Junta en EPDM.

H-M para fusión socket-rosocar latón.



INDUSTRIA

Sistema PP-H Socket

Válvulas de bola



VKDIM



| d | Ref. EPDM | DN | € | |
|----|-----------|----|--------|--------|
| | | | EPDM | FKM |
| 16 | VKDIM016E | 10 | 71,49 | 86,39 |
| 20 | VKDIM020E | 15 | 71,71 | 86,52 |
| 25 | VKDIM025E | 20 | 84,65 | 100,28 |
| 32 | VKDIM032E | 25 | 104,56 | 127,87 |
| 40 | VKDIM040E | 32 | 129,54 | 155,61 |
| 50 | VKDIM050E | 40 | 167,67 | 197,79 |
| 63 | VKDIM063E | 50 | 209,06 | 264,37 |

Válvula de bola DUAL BLOCK®. Código en FKM termina en "F" en lugar de "E"
Asiento PTFE (teflón). Bidireccional.
H-H para fusión socket.

VKDFM



| Rh | Ref. EPDM | DN | € | |
|-----|-----------|----|--------|--------|
| | | | EPDM | FKM |
| ½" | VKDFM012E | 15 | 84,65 | 100,28 |
| ¾" | VKDFM034E | 20 | 95,03 | 111,53 |
| 1" | VKDFM100E | 25 | 134,80 | 152,02 |
| 1¼" | VKDFM114E | 32 | 143,32 | 172,77 |
| 1½" | VKDFM112E | 40 | 184,87 | 216,01 |
| 2" | VKDFM200E | 50 | 236,80 | 293,82 |

Válvula de bola DUAL BLOCK®. Código en FKM termina en "F" en lugar de "E"
Asiento PTFE (teflón). Bidireccional.
H-H roscar.

VKDIM



| d | Ref. EPDM | DN | € | |
|-----|-----------|-----|--------|--------|
| | | | EPDM | FKM |
| 75 | VKDIM075E | 65 | 502,42 | 633,48 |
| 90 | VKDIM090E | 80 | 631,52 | 796,31 |
| 110 | VKDIM110E | 100 | 764,60 | 929,33 |

Válvula de bola DUAL BLOCK®. Código en FKM termina en "F" en lugar de "E"
Asiento PTFE (teflón). Bidireccional.
H-H para fusión socket.

VKDDM



| d | Ref. EPDM | DN | € | |
|----|-----------|----|--------|--------|
| | | | EPDM | FKM |
| 20 | VKDDM020E | 15 | 71,71 | 86,52 |
| 25 | VKDDM025E | 20 | 84,65 | 100,28 |
| 32 | VKDDM032E | 25 | 104,56 | 127,87 |
| 40 | VKDDM040E | 32 | 129,54 | 155,61 |
| 50 | VKDDM050E | 40 | 167,67 | 197,79 |
| 63 | VKDDM063E | 50 | 209,06 | 264,37 |

Válvula de bola DUAL BLOCK®. Código en FKM termina en "F" en lugar de "E"
Asiento PTFE (teflón). Bidireccional.
M-M para fusión socket.

VKDOM



| d | Ref. EPDM | DN | € | |
|----|-----------|----|--------|--------|
| | | | EPDM | FKM |
| 20 | VKDOM020E | 15 | 144,57 | 166,99 |
| 25 | VKDOM025E | 20 | 169,85 | 192,37 |
| 32 | VKDOM032E | 25 | 212,45 | 245,70 |
| 40 | VKDOM040E | 32 | 277,22 | 312,90 |
| 50 | VKDOM050E | 40 | 328,81 | 354,69 |
| 63 | VKDOM063E | 50 | 405,45 | 470,18 |

Válvula de bola DUAL BLOCK®. Código en FKM termina en "F" en lugar de "E"
Con brida loca. Asiento PTFE (teflón). Versión con bridas ANSI 150 lbs al mismo precio.
Bidireccional.

VKDOM



| d | Ref. EPDM | DN | € | |
|-----|-----------|-----|----------|----------|
| | | | EPDM | FKM |
| 75 | VKDOM075E | 65 | 678,30 | 809,39 |
| 90 | VKDOM090E | 80 | 852,57 | 1.017,32 |
| 110 | VKDOM110E | 100 | 1.032,21 | 1.196,94 |

Válvula de bola DUAL BLOCK®. Código en FKM termina en "F" en lugar de "E"
Con brida loca. Asiento PTFE (teflón). ANSI y DIN
Bidireccional.

VKDDM



| d | Ref. EPDM | DN | € | |
|-----|-----------|-----|--------|--------|
| | | | EPDM | FKM |
| 75 | VKDDM075E | 65 | 502,42 | 633,50 |
| 90 | VKDDM090E | 80 | 631,52 | 796,34 |
| 110 | VKDDM110E | 100 | 764,60 | 929,33 |

Válvula de bola DUAL BLOCK®. Código en FKM termina en "F" en lugar de "E"
Asiento PTFE (teflón). Bidireccional.
M-M para fusión socket.



VKRIM

| d | Ref. EPDM | DN | € | |
|----|-----------|----|--------|--------|
| | | | EPDM | FKM |
| 16 | VKRIM016E | 10 | 292,74 | 307,60 |
| 20 | VKRIM020E | 15 | 292,89 | 307,70 |
| 25 | VKRIM025E | 20 | 324,60 | 340,24 |
| 32 | VKRIM032E | 25 | 382,63 | 405,97 |
| 40 | VKRIM040E | 32 | 428,75 | 454,84 |
| 50 | VKRIM050E | 40 | 532,17 | 562,33 |
| 63 | VKRIM063E | 50 | 566,40 | 621,75 |

Válvula de bola REGULACIÓN DUAL BLOCK®.

Asiento PTFE (teflón). Bidireccional H-H para fusión socket.

Código en FKM termina en "F" en lugar de "E"



VKRFM

| Rh | Ref. EPDM | DN | € | |
|--------|-----------|----|--------|--------|
| | | | EPDM | FKM |
| 3/8" | VKRFM038E | 10 | 305,83 | 321,49 |
| 1/2" | VKRFM012E | 15 | 305,83 | 321,49 |
| 3/4" | VKRFM034E | 20 | 334,97 | 351,47 |
| 1" | VKRFM100E | 25 | 412,95 | 430,15 |
| 1 1/4" | VKRFM114E | 32 | 442,56 | 471,98 |
| 1 1/2" | VKRFM112E | 40 | 549,33 | 580,50 |
| 2" | VKRFM200E | 50 | 594,12 | 651,18 |

Válvula de bola REGULACIÓN DUAL BLOCK®.

Asiento PTFE (teflón). Bidireccional H-H roscar.

Código en FKM termina en "F" en lugar de "E"



VKDBM

| d | Ref. EPDM | DN | € | |
|----|-----------|----|--------|--------|
| | | | EPDM | FKM |
| 20 | VKDBM020E | 15 | 79,46 | 95,03 |
| 25 | VKDBM025E | 20 | 93,34 | 111,56 |
| 32 | VKDBM032E | 25 | 113,20 | 139,86 |
| 40 | VKDBM040E | 32 | 141,61 | 172,77 |
| 50 | VKDBM050E | 40 | 183,15 | 217,72 |
| 63 | VKDBM063E | 50 | 228,13 | 291,96 |

Válvula de bola DUAL BLOCK®.

Asiento PTFE (teflón). Bidireccional M-M para soldadura a testa.

Código en FKM termina en "F" en lugar de "E"



VKDBEM

| d | Ref. EPDM | DN | € | |
|----|------------|----|--------|--------|
| | | | EPDM | FKM |
| 20 | VKDBEM020E | 15 | 79,46 | 95,03 |
| 25 | VKDBEM025E | 20 | 93,34 | 111,53 |
| 32 | VKDBEM032E | 25 | 113,20 | 139,86 |
| 40 | VKDBEM040E | 32 | 141,61 | 172,77 |
| 50 | VKDBEM050E | 40 | 183,15 | 217,72 |
| 63 | VKDBEM063E | 50 | 228,13 | 291,96 |

Válvula de bola DUAL BLOCK®.

Asiento PTFE (teflón). Bidireccional M-M para soldadura a testa.

Código en FKM termina en "F" en lugar de "E"



VKDBM

| d | Ref. EPDM | DN | € | |
|-----|-----------|-----|--------|----------|
| | | | EPDM | FKM |
| 75 | VKDBM075E | 65 | 552,13 | 683,23 |
| 90 | VKDBM090E | 80 | 695,06 | 859,83 |
| 110 | VKDBM110E | 100 | 839,95 | 1.004,70 |

Válvula de bola DUAL BLOCK®.

Asiento PTFE (teflón). Bidireccional M-M para soldadura a testa.

Código en FKM termina en "F" en lugar de "E"



VKDBEM

| d | Ref. EPDM | DN | € | |
|-----|------------|-----|--------|----------|
| | | | EPDM | FKM |
| 75 | VKDBEM075E | 65 | 552,13 | 683,23 |
| 90 | VKDBEM090E | 80 | 695,06 | 859,83 |
| 110 | VKDBEM110E | 100 | 839,95 | 1.004,70 |

Válvula de bola DUAL BLOCK®.

Asiento PTFE (teflón). Bidireccional Long spigot PE100 SDR11.

Código en FKM termina en "F" en lugar de "E"



Sistema PP-H Socket Válvulas de 3 vías



VKROM

| d | Ref. EPDM | DN | € EPDM | € FKM |
|----|-----------|----|-----------|----------|
| 20 | VKROM020E | 15 | 365,80 | 388,21 |
| 25 | VKROM025E | 20 | 409,79 | 432,31 |
| 32 | VKROM032E | 25 | 490,55 | 523,85 |
| 40 | VKROM040E | 32 | 576,46 | 612,11 |
| 50 | VKROM050E | 40 | 693,29 | 719,21 |
| 63 | VKROM063E | 50 | 762,81 | 827,51 |

Válvula de bola **REGULACIÓN**
DUAL BLOCK®.
Asiento PTFE (teflón). Bidireccional
Con Brida DIN 2501

Código en FKM termina en "F"
en lugar de "E"



VKROAM

| d | Ref. EPDM | DN | € EPDM | € FKM |
|-----|------------|----|-----------|----------|
| ½" | VKROAM012E | 15 | 365,80 | 388,21 |
| ¾" | VKROAM034E | 20 | 409,79 | 432,31 |
| 1" | VKROAM100E | 25 | 490,55 | 523,85 |
| 1¼" | VKROAM114E | 32 | 576,46 | 612,11 |
| 1½" | VKROAM112E | 40 | 693,29 | 719,21 |
| 2" | VKROAM200E | 50 | 762,81 | 762,81 |

Válvula de bola **REGULACIÓN**
DUAL BLOCK®.
Asiento PTFE (teflón). Bidireccional
Con bridas ANSI 150 lbs.

Código en FKM termina en "F"
en lugar de "E"



TKDIM

| d x d x Rh | Ref. EPDM | DN | Apertura | € EPDM |
|--------------|------------|----|-----------|-----------|
| 32 x 32 x ¼" | TKDIM032ED | 25 | Derecha | Consultar |
| 32 x 32 x ¼" | TKDIM032ES | 25 | Izquierda | Consultar |

Válvula de bola 3 vías
DESALACIÓN DUAL BLOCK®.
H-H-H para fusión socket-rosca 1/4"
toma muestras. Asiento PTFE (teflón).

Bajo pedido
suministramos otros diámetros
Disponibles también
con juntas en FKM



TKDIM

| d | Ref. EPDM | DN | € EPDM | € FKM |
|----|-----------|----|-----------|----------|
| 20 | TKDIM020E | 15 | 128,62 | 145,33 |
| 25 | TKDIM025E | 20 | 144,52 | 166,17 |
| 32 | TKDIM032E | 25 | 185,43 | 213,24 |
| 40 | TKDIM040E | 32 | 211,52 | 249,58 |
| 50 | TKDIM050E | 40 | 250,37 | 312,97 |
| 63 | TKDIM063E | 50 | 316,58 | 395,71 |

Válvula de bola 3 vías
DUAL BLOCK®. **PASO T.**
H-H-H para fusión socket. Asiento PTFE
(teflón).

Código en FKM termina en "F"
en lugar de "E"



TKDFM

| Rh | Ref. EPDM | DN | € EPDM | € FKM |
|-----|-----------|----|-----------|----------|
| ½" | TKDFM012E | 15 | 143,14 | 159,87 |
| ¾" | TKDFM034E | 20 | 161,18 | 182,84 |
| 1" | TKDFM100E | 25 | 206,76 | 234,60 |
| 1¼" | TKDFM114E | 32 | 236,51 | 274,56 |
| 1½" | TKDFM112E | 40 | 281,64 | 344,17 |
| 2" | TKDFM200E | 50 | 356,19 | 435,32 |

Válvula de bola 3 vías
DUAL BLOCK®. **PASO T.**
H-H-H roscar. Asiento PTFE (teflón).

Código en FKM termina en "F"
en lugar de "E"



LKDIM

| d | Ref. EPDM | DN | € EPDM | € FKM |
|----|-----------|----|-----------|----------|
| 20 | LKDIM020E | 15 | 150,38 | 167,15 |
| 25 | LKDIM025E | 20 | 169,48 | 191,13 |
| 32 | LKDIM032E | 25 | 217,43 | 245,29 |
| 40 | LKDIM040E | 32 | 249,04 | 287,08 |
| 50 | LKDIM050E | 40 | 297,25 | 359,86 |
| 63 | LKDIM063E | 50 | 375,90 | 455,13 |

Válvula de bola 3 vías
DUAL BLOCK®. **PASO L.**
H-H-H para fusión socket. Asiento PTFE
(teflón).

Código en FKM termina en "F"
en lugar de "E"



INDUSTRIA

Sistema PP-H Socket

Válvulas de mariposa



LKDFM

| Rh | Ref. EPDM | DN | € EPDM | € FKM |
|--------|-----------|----|-----------|----------|
| 1/2" | LKDFM012E | 15 | 164,90 | 181,65 |
| 3/4" | LKDFM034E | 20 | 186,09 | 207,74 |
| 1" | LKDFM100E | 25 | 238,74 | 266,58 |
| 1 1/4" | LKDFM114E | 32 | 273,90 | 312,04 |
| 1 1/2" | LKDFM112E | 40 | 328,60 | 391,11 |
| 2" | LKDFM200E | 50 | 415,48 | 494,67 |

Válvula de bola 3 vías
DUAL BLOCK®. **PASO L.**
H-H-H roscar. Asiento PTFE (teflón).

Código en FKM termina en "F"
en lugar de "E"



SETFLOM

| d DIN | d ANSI | Ref. DIN | € DIN 2501 | € ANSI |
|-------|--------|------------|---------------|-----------|
| 20 | 1/2" | SETFLOM020 | 52,38 | 52,38 |
| 25 | 3/4" | SETFLOM025 | 60,55 | 60,55 |
| 32 | 1" | SETFLOM032 | 66,48 | 66,48 |
| 40 | 1 1/4" | SETFLOM040 | 88,11 | 88,11 |
| 50 | 1 1/2" | SETFLOM050 | 91,64 | 91,64 |
| 63 | 2" | SETFLOM063 | 117,08 | 117,08 |
| 75 | 2 1/2" | SETFLOM075 | 260,83 | 260,83 |
| 90 | 3" | SETFLOM090 | 316,92 | 316,92 |
| 110 | 4" | SETFLOM110 | 370,33 | 370,33 |

Set embrizado
Compuesto por 1 brida, 1 anillo fijación y 1 tuerca.
Para Válvulas VKD / VKR / TKD / RVU / VRU .

d. 75-90-110,
es el mismo artículo
para DIN y ANSI



FKOM/FM

| d | Ref. EPDM | DN | € EPDM | € FKM |
|-------|------------|-----|-----------|-----------|
| 50 | FKOMFM050E | 40 | 332,40 | 501,16 |
| 63 | FKOMFM063E | 50 | 351,99 | 530,67 |
| 75 | FKOMFM075E | 65 | 391,11 | 589,58 |
| 90 | FKOMFM090E | 80 | 425,15 | 632,57 |
| 110 | FKOMFM110E | 100 | 462,20 | 676,98 |
| 125 | FKOMFM140E | 125 | 613,30 | 906,62 |
| 140 | FKOMFM140E | 125 | 613,30 | 906,62 |
| 160 | FKOMFM160E | 150 | 676,98 | 973,30 |
| 200 | FKOMFM225E | 200 | 876,98 | 1.263,66 |
| 225 | FKOMFM225E | 200 | 876,98 | 1.263,66 |
| 250** | FKOMFM280E | 250 | 2.794,31 | 4.521,80 |
| 280** | FKOMFM280E | 250 | 2.794,31 | 4.521,80 |
| 315** | FKOMFM315E | 300 | 3.047,69 | 4.930,76 |
| 355** | FKOMFM355E | 350 | 4.787,71 | 8.706,17 |
| 400** | FKOMFM400E | 400 | 5.530,02 | 11.185,88 |

Válvula de mariposa industrial.
A EJE LIBRE.

Para actuar. Cuerpo en PPGR,
eje inoxidable y disco en PP-H.

Código en FKM termina en "F"
en lugar de "E"

** ANSI 150 lbs bajo pedido
al mismo precio.



FKOM/LM

| d | Ref. EPDM | DN | € EPDM | € FKM |
|-----|-------------|-----|-----------|----------|
| 50 | FKO MLM050E | 40 | 390,34 | 556,59 |
| 63 | FKO MLM063E | 50 | 413,30 | 589,29 |
| 75 | FKO MLM075E | 65 | 459,23 | 654,76 |
| 90 | FKO MLM090E | 80 | 482,92 | 687,38 |
| 110 | FKO MLM110E | 100 | 524,42 | 734,76 |
| 125 | FKO MLM140E | 125 | 696,25 | 985,10 |
| 140 | FKO MLM140E | 125 | 696,25 | 985,10 |
| 160 | FKO MLM160E | 150 | 752,51 | 1.025,12 |
| 200 | FKO MLM225E | 200 | 974,72 | 1.330,29 |
| 225 | FKO MLM225E | 200 | 974,72 | 1.330,29 |

Válvula de mariposa industrial.

CON MANETA.

Cuerpo en PPGR,
eje inoxidable y disco en PP-H.

Código en FKM termina en "F"
en lugar de "E"



FKOM/RM

| d | Ref. EPDM | DN | € EPDM | € FKM |
|-------|------------|-----|-----------|-----------|
| 75 | FKOMRM075E | 65 | 1.044,53 | 1.248,81 |
| 90 | FKOMRM090E | 80 | 1.078,44 | 1.281,42 |
| 110 | FKOMRM110E | 100 | 1.119,88 | 1.330,29 |
| 125 | FKOMRM140E | 125 | 1.291,81 | 1.580,66 |
| 140 | FKOMRM140E | 125 | 1.291,81 | 1.580,66 |
| 160 | FKOMRM160E | 150 | 1.348,08 | 1.620,66 |
| 200 | FKOMRM225E | 200 | 1.705,10 | 2.040,63 |
| 225 | FKOMRM225E | 200 | 1.705,10 | 2.040,63 |
| 250** | FKOMRM280E | 250 | 3.186,77 | 4.897,59 |
| 280** | FKOMRM280E | 250 | 3.186,77 | 4.897,59 |
| 315** | FKOMRM315E | 300 | 3.471,39 | 5.354,47 |
| 355** | FKOMRM355E | 350 | 5.880,08 | 9.703,44 |
| 400** | FKOMRM400E | 400 | 6.622,40 | 12.278,24 |

Válvula de mariposa industrial.

CON VOLANTE.

Cuerpo en PPGR,

eje inoxidable y disco en PP-H.

Código en FKM termina en "F"
en lugar de "E"** ANSI 150 lbs bajo pedido
al mismo precio.

FKOM/RM

| d | Ref. EPDM | DN | € EPDM | € FKM |
|-----|-------------|-----|-----------|----------|
| 75 | FKOLMRM075E | 65 | 1.238,43 | 1.418,59 |
| 90 | FKOLMRM090E | 80 | 1.318,48 | 1.506,59 |
| 110 | FKOLMRM110E | 100 | 1.380,70 | 1.575,56 |
| 125 | FKOLMRM140E | 125 | 1.639,89 | 1.910,04 |
| 140 | FKOLMRM140E | 125 | 1.639,89 | 1.910,04 |
| 160 | FKOLMRM160E | 150 | 1.724,41 | 1.977,51 |
| 200 | FKOLMRM225E | 200 | 2.094,68 | 2.426,43 |
| 225 | FKOLMRM225E | 200 | 2.094,68 | 2.426,43 |

Válvula de mariposa industrial.

CON VOLANTE. LUG ISO-DIN

Cuerpo en PPGR,

eje inoxidable y disco en PP-H.

Código en FKM termina en "F"
en lugar de "E"

FKOM/LM

| d | Ref. EPDM | DN | € EPDM | € FKM |
|-----|-------------|-----|-----------|----------|
| 75 | FKOLMLM075E | 65 | 636,69 | 830,33 |
| 90 | FKOLMLM090E | 80 | 715,91 | 927,37 |
| 110 | FKOLMLM110E | 100 | 777,53 | 995,54 |
| 125 | FKOLMLM140E | 125 | 1.034,20 | 1.320,27 |
| 140 | FKOLMLM140E | 125 | 1.034,20 | 1.320,27 |
| 160 | FKOLMLM160E | 150 | 1.117,89 | 1.387,80 |
| 200 | FKOLMLM225E | 200 | 1.351,16 | 1.703,19 |
| 225 | FKOLMLM225E | 200 | 1.351,16 | 1.703,19 |

Válvula de mariposa industrial.

CON MANETA. LUG ISO-DIN

Cuerpo en PPGR,

eje inoxidable y disco en PP-H.

Código en FKM termina en "F"
en lugar de "E"

FKOM/LM

| d | Ref. EPDM | DN | € EPDM | € FKM |
|----|--------------|-----|-----------|----------|
| ½" | FKOALMLM212E | 65 | 727,63 | 921,24 |
| 3" | FKOALMLM300E | 80 | 811,19 | 1.013,70 |
| 4" | FKOALMLM400E | 100 | 881,70 | 1.100,65 |
| 5" | FKOALMLM500E | 125 | 1.172,11 | 1.458,21 |
| 6" | FKOALMLM600E | 150 | 1.267,49 | 1.537,41 |
| 8" | FKOALMLM800E | 200 | 1.543,21 | 1.895,31 |

Válvula de mariposa industrial.

CON MANETA. LUG ANSI

Cuerpo en PPGR,

eje inoxidable y disco en PP-H.

Código en FKM termina en "F"
en lugar de "E"

FKOM/RM

| d | Ref. EPDM | DN | € EPDM | € FKM |
|-----|--------------|-----|-----------|----------|
| 2½" | FKOALMRM212E | 65 | 1.317,37 | 1.509,55 |
| 3" | FKOALMRM300E | 80 | 1.400,98 | 1.601,95 |
| 4" | FKOALMRM400E | 100 | 1.471,39 | 1.679,76 |
| 5" | FKOALMRM500E | 125 | 1.761,91 | 2.047,89 |
| 6" | FKOALMRM600E | 150 | 1.857,27 | 2.127,15 |
| 8" | FKOALMRM800E | 200 | 2.266,47 | 2.618,57 |
| 10" | FKOALMRM810E | 250 | 5.036,42 | 6.747,22 |
| 12" | FKOALMRM812E | 300 | 5.329,65 | 7.194,48 |

Válvula de mariposa industrial.

CON VOLANTE. LUG ANSI

Cuerpo en PPGR,

eje inoxidable y disco en PP-H.

Código en FKM termina en "F"
en lugar de "E"



DKDM

| d | Ref. EPDM | DN | PN | € EPDM | € FKM | € PTFE |
|----|-----------|----|----|-----------|----------|-----------|
| 20 | DKDM020E | 15 | 10 | 140,74 | 217,89 | 250,74 |
| 25 | DKDM025E | 20 | 10 | 152,34 | 233,34 | 264,24 |
| 32 | DKDM032E | 25 | 10 | 179,30 | 258,34 | 289,30 |
| 40 | DKDM040E | 32 | 10 | 210,12 | 341,35 | 377,82 |
| 50 | DKDM050E | 40 | 10 | 273,74 | 404,94 | 441,45 |
| 63 | DKDM063E | 50 | 10 | 331,71 | 553,33 | 549,57 |
| 75 | DKDM075E | 65 | 10 | 398,08 | 663,96 | 659,47 |

Válvula de membrana
DIALOCK®.
M-M para soldar socket.

Código en FKM termina en "F"
en lugar de "E"
Código en PTFE termina en "P"
en lugar de "E"



DKOM

| d | Ref. EPDM | DN | PN | € EPDM | € FKM | € PTFE |
|----|-----------|----|----|-----------|----------|-----------|
| 20 | DKOM020E | 15 | 10 | 213,11 | 290,24 | 323,05 |
| 25 | DKOM025E | 20 | 10 | 228,95 | 309,95 | 340,88 |
| 32 | DKOM032E | 25 | 10 | 258,58 | 337,62 | 368,55 |
| 40 | DKOM040E | 32 | 10 | 314,60 | 445,80 | 482,28 |
| 50 | DKOM050E | 40 | 10 | 383,03 | 514,16 | 550,68 |
| 63 | DKOM063E | 50 | 10 | 483,34 | 705,02 | 701,19 |
| 75 | DKOM075E | 65 | 10 | 628,33 | 916,48 | 911,50 |

Válvula de membrana
DIALOCK®.
Con bridas DIN.

Código en FKM termina en "F"
en lugar de "E"
Código en PTFE termina en "P"
en lugar de "E"



VMDM

| d | Ref. EPDM | DN | € EPDM | € FKM | € PTFE |
|-----|-----------|-----|-----------|----------|-----------|
| 90 | VMDM090E | 80 | 885,01 | 1.517,41 | 1.179,96 |
| 110 | VMDM110E | 100 | 1.176,18 | 2.224,95 | 1.540,51 |

Válvula de membrana.
M-M para fusión socket.

Código en FKM termina en "F"
en lugar de "E"
Código en PTFE termina en "P"
en lugar de "E"
*PN6



VMOM

| d | Ref. EPDM | DN | € EPDM | € FKM | € PTFE |
|-----|-----------|-----|-----------|----------|-----------|
| 90 | VMOM090E | 80 | 1.182,78 | 1.815,15 | 1.477,78 |
| 110 | VMOM110E | 100 | 1.514,68 | 2.563,45 | 1.879,01 |

Válvula de membrana.
Con bridas DIN. Bajo pedido
con bridas ANSI 150 lbs. mismo precio.

Código en FKM termina en "F"
en lugar de "E"
Código en PTFE termina en "P"
en lugar de "E"
*PN6



DKOAM

| d | Ref. EPDM | DN | PN | € EPDM | € FKM | € PTFE |
|-----|-----------|----|----|-----------|----------|-----------|
| ½" | DKOAM012E | 15 | 10 | 213,11 | 290,24 | 323,05 |
| ¾" | DKOAM034E | 20 | 10 | 228,95 | 309,95 | 340,88 |
| 1" | DKOAM100E | 25 | 10 | 258,58 | 337,62 | 368,55 |
| 1¼" | DKOAM114E | 32 | 10 | 314,60 | 445,80 | 482,28 |
| 1½" | DKOAM112E | 40 | 10 | 383,03 | 514,16 | 550,68 |
| 2" | DKOAM200E | 50 | 10 | 483,34 | 705,02 | 701,19 |
| 2½" | DKOAM212E | 65 | 10 | 628,33 | 916,48 | 911,50 |

Válvula de membrana
DIALOCK®.
Con bridas ANSI 150 lbs.

Código en FKM termina en "F"
en lugar de "E"
Código en PTFE termina en "P"
en lugar de "E"



DKUIM

| d | Ref. EPDM | DN | PN | € EPDM | € FKM | € PTFE |
|----|-----------|----|----|-----------|----------|-----------|
| 20 | DKUIM020E | 15 | 10 | 163,90 | 241,05 | 273,74 |
| 25 | DKUIM025E | 20 | 10 | 175,44 | 256,42 | 287,24 |
| 32 | DKUIM032E | 25 | 10 | 204,41 | 283,47 | 314,20 |
| 40 | DKUIM040E | 32 | 10 | 237,27 | 368,35 | 404,94 |
| 50 | DKUIM050E | 40 | 10 | 303,80 | 431,96 | 468,43 |
| 63 | DKUIM063E | 50 | 10 | 372,07 | 593,84 | 589,97 |

Válvula de membrana
DIALOCK®.
Con enlaces H-H para soldar socket.

Código en FKM termina en "F"
en lugar de "E"
Código en PTFE termina en "P"
en lugar de "E"



INDUSTRIA

Sistema PP-H Socket

Válvulas anti-retorno



DKLUIM



| d | Ref. EPDM | DN | PN | € EPDM | € FKM | € PTFE |
|----|------------|----|----|-----------|--------|--------|
| 20 | DKLUIM020E | 15 | 10 | 305,69 | 379,80 | 411,21 |
| 25 | DKLUIM025E | 20 | 10 | 316,80 | 394,61 | 424,18 |
| 32 | DKLUIM032E | 25 | 10 | 344,63 | 420,58 | 450,11 |
| 40 | DKLUIM040E | 32 | 10 | 376,17 | 502,17 | 537,36 |
| 50 | DKLUIM050E | 40 | 10 | Consultar | 605,63 | 640,69 |
| 63 | DKLUIM063E | 50 | 10 | 548,09 | 761,22 | 757,50 |

Válvula de membrana
DIALOCK®. **CON LIMITADOR
DE CARRERA.**

Con enlaces H-H para soldar socket.

Código en FKM termina en "F"
en lugar de "E"
Código en PTFE termina en "P"
en lugar de "E"

CMDM
M-M fusión
socket.

CMUIM
H-H enlaces
socket.

CMIM
H-H fusión
socket.

CMFM
H-H roscar.



| d-Rh | Ref. EPDM | DN | € EPDM | € FKM | € PTFE |
|------|-----------|----|--------|--------|--------|
| 20 | CMDM020E | 15 | 162,03 | 171,54 | 185,18 |
| 16 | CMIM016E | 12 | 90,59 | 123,45 | 138,86 |
| 20 | CMIM020E | 15 | 90,59 | 123,45 | 138,86 |
| 20 | CMUIM020E | 15 | 144,54 | 175,44 | 192,80 |
| ¾" | CMFM038E | 12 | 90,59 | 123,45 | 138,86 |
| ½" | CMFM012E | 15 | 90,59 | 123,45 | 138,86 |

Válvula de membrana
compacta.

Código en FKM termina en "F"
en lugar de "E"
Código en PTFE termina en "P"
en lugar de "E"

VRUIM



| d | Ref. EPDM | DN | PN | € EPDM | € FKM |
|----|-----------|----|----|--------|--------|
| 20 | VRUIM020E | 15 | 10 | 78,47 | 84,88 |
| 25 | VRUIM025E | 20 | 10 | 88,77 | 97,29 |
| 32 | VRUIM032E | 25 | 10 | 92,17 | 105,53 |
| 40 | VRUIM040E | 32 | 10 | 112,00 | 128,30 |
| 50 | VRUIM050E | 40 | 10 | 126,74 | 155,16 |
| 63 | VRUIM063E | 50 | 10 | 193,69 | 235,79 |

Válvula anti-retorno inclinada.
Juntas en EPDM o FKM.

H-H con enlaces para fusión socket

Código en FKM termina en "F"
en lugar de "E"

VRUFM



| Rh | Ref. EPDM | DN | PN | Pack | € FKM |
|-----|-----------|----|----|------|--------|
| ½" | VRUFM012F | 15 | 10 | 2 | 90,00 |
| ¾" | VRUFM034F | 20 | 10 | 2 | 103,08 |
| 1" | VRUFM100F | 25 | 10 | 2 | 113,96 |
| 1¼" | VRUFM114F | 32 | 10 | 2 | 135,99 |
| 1½" | VRUFM112F | 40 | 10 | 2 | 164,51 |
| 2" | VRUFM200F | 50 | 10 | 2 | 247,57 |

Válvula anti-retorno inclinada.
Juntas en FKM.

H-H con enlaces para roscar.

VRIM



| d | Ref. EPDM | DN | PN | € EPDM | € FKM |
|----|-----------|----|----|--------|--------|
| 75 | VRIM075E | 65 | 6 | 434,74 | 473,48 |
| 90 | VRIM090E | 80 | 4 | 710,04 | 779,44 |

Válvula anti-retorno inclinada.
Juntas en EPDM o FKM.

H-H para fusión socket
(sin enlaces en los extremos).

Código en FKM termina en "F"
en lugar de "E"

**RVUIM**

| d | Ref. EPDM | DN | PN | € | |
|----|-----------|----|----|--------|--------|
| | | | | EPDM | FKM |
| 20 | RVUIM020E | 15 | 10 | 91,67 | 99,52 |
| 25 | RVUIM025E | 20 | 10 | 114,60 | 124,10 |
| 32 | RVUIM032E | 25 | 10 | 138,71 | 145,20 |
| 40 | RVUIM040E | 32 | 10 | 151,91 | 168,95 |
| 50 | RVUIM050E | 40 | 10 | 165,56 | 194,82 |
| 63 | RVUIM063E | 50 | 10 | 228,74 | 268,22 |

Filtro inclinado.

Juntas en EPDM o FKM.

H-H con enlaces para fusión socket.

Código en FKM termina en "F"
en lugar de "E"**RVUFM**

| Rh | Ref. EPDM | DN | PN | Pack | € | |
|-----|-----------|----|----|------|--------|-----|
| | | | | | EPDM | FKM |
| ½" | RVUFM012F | 15 | 10 | 2 | 105,53 | |
| ¾" | RVUFM034F | 20 | 10 | 2 | 131,60 | |
| 1" | RVUFM100F | 25 | 10 | 2 | 156,85 | |
| 1¼" | RVUFM114F | 32 | 10 | 2 | 179,07 | |
| 1½" | RVUFM112F | 40 | 10 | 2 | 206,53 | |
| 2" | RVUFM200F | 50 | 10 | 2 | 281,61 | |

Filtro inclinado.

Juntas en FKM.

H-H con enlaces para rosacar.

**RVIM**

| d | Ref. EPDM | DN | PN | € | |
|-----|-----------|-----|----|--------|--------|
| | | | | EPDM | FKM |
| 75 | RVIM075E | 65 | 6 | 292,84 | 298,92 |
| 90 | RVIM090E | 80 | 4 | 362,34 | 383,63 |
| 110 | RVIM110E | 100 | 4 | 663,35 | 755,28 |

Filtro inclinado.

Juntas en EPDM o FKM.

H-H para fusión socket
(sin enlaces en los extremos).Código en FKM termina en "F"
en lugar de "E"**SRIM**

| d | Ref. EPDM | DN | PN | Pack | € | |
|----|-----------|----|----|------|--------|-----|
| | | | | | EPDM | FKM |
| 20 | SRIM020F | 15 | 10 | 2 | 81,18 | |
| 25 | SRIM025F | 20 | 10 | 2 | 89,90 | |
| 32 | SRIM032F | 25 | 10 | 2 | 98,54 | |
| 40 | SRIM040F | 32 | 10 | 2 | 121,04 | |
| 50 | SRIM050F | 40 | 10 | 2 | 143,32 | |
| 63 | SRIM063F | 50 | 10 | 2 | 215,17 | |

Válvula de bola anti-retorno.

Juntas en FKM.

M-H para fusión socket.



FROM

| d | Ref. EPDM | DN | PN | € EPDM | € FKM |
|-----|-----------|-----|----|-----------|----------|
| 40 | FROM040E | 32 | 6 | 374,87 | 607,01 |
| 50 | FROM050E | 40 | 6 | 374,87 | 615,15 |
| 63 | FROM063E | 50 | 6 | 397,50 | 652,21 |
| 75 | FROM075E | 65 | 6 | 487,75 | 809,43 |
| 90 | FROM090E | 80 | 6 | 532,06 | 906,98 |
| 110 | FROM110E | 100 | 6 | 653,78 | 1.087,60 |
| 140 | FROM140E | 125 | 6 | 869,88 | 1.364,97 |
| 160 | FROM160E | 150 | 6 | 899,64 | 1.476,87 |
| 225 | FROM225E | 200 | 6 | 1.131,94 | 1.746,96 |
| 280 | FROM280E | 250 | 6 | 1.731,62 | 2.564,51 |
| 315 | FROM315E | 300 | 6 | 2.429,06 | 3.418,96 |

Válvula anti-retorno de clapeta sin resorte.

ISO/DIN

Código en FKM termina en "F" en lugar de "E"



FROM

| d | Ref. EPDM | DN | PN | € EPDM | € FKM |
|-----|-------------|-----|----|-----------|----------|
| 1¼" | FROM040EMLX | 32 | 6 | 500,61 | 732,78 |
| 1½" | FROM050EMLX | 40 | 6 | 500,61 | 740,91 |
| 2" | FROM063EMLX | 50 | 6 | 531,24 | 786,02 |
| 2½" | FROM075EMLX | 65 | 6 | 628,77 | 950,40 |
| 3" | FROM090EMLX | 80 | 6 | 680,36 | 1.055,25 |
| 4" | FROM110EMLX | 100 | 6 | 817,43 | 1.251,21 |
| 5" | FROM140EMLX | 125 | 6 | 1.033,51 | 1.528,52 |
| 6" | FROM160EMLX | 150 | 6 | 1.110,63 | 1.687,93 |
| 8" | FROM225EMLX | 200 | 6 | 1.372,75 | 1.987,80 |
| 10" | FROM280EMLX | 250 | 6 | 2.019,49 | 2.852,36 |
| 12" | FROM315EMLX | 300 | 6 | 2.761,21 | 3.751,13 |

Válvula anti-retorno de clapeta con resorte inox.

ISO/DIN

Código en FKM termina en "F" en lugar de "E"



FROAM

| d | Ref. EPDM | DN | PN | € EPDM | € FKM |
|-----|-----------|-----|----|-----------|----------|
| 1¼" | FROAM114E | 32 | 6 | 460,70 | 692,85 |
| 1½" | FROAM112E | 40 | 6 | 439,78 | 688,12 |
| 2" | FROAM200E | 50 | 6 | 477,42 | 732,20 |
| 2½" | FROAM212E | 65 | 6 | 579,50 | 901,15 |
| 3" | FROAM300E | 80 | 6 | 638,94 | 1.013,81 |
| 4" | FROAM400E | 100 | 6 | 775,44 | 1.217,22 |
| 5" | FROAM500E | 125 | 6 | 1.032,70 | 1.527,71 |
| 6" | FROAM600E | 150 | 6 | 1.060,34 | 1.637,55 |
| 8" | FROAM800E | 200 | 6 | 1.375,93 | 1.991,04 |
| 10" | FROAM810E | 250 | 6 | 2.045,92 | 2.878,66 |
| 12" | FROAM812E | 300 | 6 | 2.951,40 | 3.941,42 |

Válvula anti-retorno de clapeta sin resorte.

ANSI 150 lbs.

Código en FKM termina en "F" en lugar de "E"



FROAM

| d | Ref. EPDM | DN | PN | € EPDM | € FKM |
|-----|--------------|-----|----|-----------|----------|
| 1¼" | FROAM114EMLX | 32 | 6 | 586,44 | 818,58 |
| 1½" | FROAM112EMLX | 40 | 6 | 565,52 | 813,83 |
| 2" | FROAM200EMLX | 50 | 6 | 611,18 | 865,94 |
| 2½" | FROAM212EMLX | 65 | 6 | 720,53 | 1.042,17 |
| 3" | FROAM300EMLX | 80 | 6 | 787,26 | 1.162,08 |
| 4" | FROAM400EMLX | 100 | 6 | 939,04 | 1.380,81 |
| 5" | FROAM500EMLX | 125 | 6 | 1.196,33 | 1.691,31 |
| 6" | FROAM600EMLX | 150 | 6 | 1.271,34 | 1.848,53 |
| 8" | FROAM800EMLX | 200 | 6 | 1.616,81 | 2.231,93 |
| 10" | FROAM810EMLX | 250 | 6 | 2.333,74 | 3.166,51 |
| 12" | FROAM812EMLX | 300 | 6 | 3.283,59 | 4.273,57 |

Válvula anti-retorno de clapeta con resorte inox.

ANSI 150 lbs.

Código en FKM termina en "F" en lugar de "E"



INDUSTRIA

Sistema PP-H Socket

Válvulas de bola actuadas



VKDIM/CE

soldar.

VKDFM/CE

roscar.

ACTUACIÓN ELÉCTRICA

ACTUACIÓN ELÉCTRICA CON BLOQUE DE SEGURIDAD

| d-Rh | 24-240 V AC/DC | | 24-240 V AC/DC | | 24-240 V AC/DC | | 24-240 V AC/DC | |
|--------|----------------|----------|----------------|----------|----------------|----------|----------------|----------|
| | Ref. | € EPDM | Ref. | € FKM | Ref. | € EPDM | Ref. | € FKM |
| 16 | VKME016E2D | 655,29 | VKME016F2D | 670,07 | VKME016E2BD | 1.209,94 | VKME016F2BD | 1.224,72 |
| 20 | VKME020E2D | 655,44 | VKME020F2D | 670,17 | VKME020E2BD | 1.210,10 | VKME020F2BD | 1.224,82 |
| 25 | VKME025E2D | 671,20 | VKME025F2D | 686,73 | VKME025E2BD | 1.225,89 | VKME025F2BD | 1.241,39 |
| 32 | VKME032E2D | 690,95 | VKME032F2D | 714,15 | VKME032E2BD | 1.245,63 | VKME032F2BD | 1.268,84 |
| 40 | VKME040E2D | 723,04 | VKME040F2D | 749,00 | VKME040E2BD | 1.277,72 | VKME040F2BD | 1.303,67 |
| 50 | VKME050E2D | 760,94 | VKME050F2D | 790,86 | VKME050E2BD | 1.315,65 | VKME050F2BD | 1.345,54 |
| 63 | VKME063E2D | 805,67 | VKME063F2D | 860,67 | VKME063E2BD | 1.360,35 | VKME063F2BD | 1.415,35 |
| 75 | VKME075E2D | 1.296,15 | VKME075F2D | 1.426,53 | VKME075E2BD | 1.850,84 | VKME075F2BD | 1.981,15 |
| 90 | VKME090E2D | 1.424,59 | VKME090F2D | 1.588,47 | VKME090E2BD | 1.979,28 | VKME090F2BD | 2.143,15 |
| 110 | VKME110E2D | 1.934,55 | VKME110F2D | 2.098,32 | VKME110E2BD | 2.489,20 | VKME110F2BD | 2.653,00 |
| 3/8" | VKME038E2D | 668,35 | VKME038F2D | 683,87 | VKME038E2BD | 1.222,97 | VKME038F2BD | 1.238,52 |
| 1/2" | VKME012E2D | 668,35 | VKME012F2D | 683,87 | VKME012E2BD | 1.222,97 | VKME012F2BD | 1.238,52 |
| 3/4" | VKME034E2D | 681,50 | VKME034F2D | 697,91 | VKME034E2BD | 1.236,19 | VKME034F2BD | 1.252,58 |
| 1" | VKME100E2D | 721,10 | VKME100F2D | 738,23 | VKME100E2BD | 1.275,79 | VKME100F2BD | 1.292,91 |
| 1 1/4" | VKME114E2D | 736,81 | VKME114F2D | 766,01 | VKME114E2BD | 1.291,44 | VKME114F2BD | 1.320,70 |
| 1 1/2" | VKME112E2D | 778,04 | VKME112F2D | 809,07 | VKME112E2BD | 1.332,75 | VKME112F2BD | 1.363,70 |
| 2" | VKME200E2D | 833,20 | VKME200F2D | 889,92 | VKME200E2BD | 1.387,87 | VKME200F2BD | 1.444,61 |

Válvula de bola motorizada en PP-H 2 vías DUAL BLOCK®. Actuación eléctrica.

Disponemos de otras conexiones bajo pedido: bridas, soldar macho y roscar (NPT) Bajo pedido podemos suministrar otros actuadores: VALPES, BELIMO... Bajo pedido también disponibles en 12 V AC/DC

VKRIM/CE

soldar.

VKRFM/CE

roscar.

ACTUACIÓN ELÉCTRICA 24-240 V AC/DC CON POSICIONADOR 4-20 mA

| d | Ref. | € EPDM | Ref. | € FKM | Ref. | € EPDM | Ref. | € FKM | Rh |
|----|-------------|----------|-------------|----------|-------------|----------|-------------|----------|--------|
| 16 | VRME016E2PD | 1.339,24 | VRME016F2PD | 1.354,02 | VRME038E2PD | 1.352,29 | VRME038F2PD | 1.367,87 | 3/8" |
| 20 | VRME020E2PD | 1.339,44 | VRME020F2PD | 1.354,14 | VRME012E2PD | 1.352,29 | VRME012F2PD | 1.367,87 | 1/2" |
| 25 | VRME025E2PD | 1.373,79 | VRME025F2PD | 1.389,40 | VRME034E2PD | 1.384,11 | VRME034F2PD | 1.400,49 | 3/4" |
| 32 | VRME032E2PD | 1.431,55 | VRME032F2PD | 1.454,75 | VRME100E2PD | 1.461,62 | VRME100F2PD | 1.478,75 | 1" |
| 40 | VRME040E2PD | 1.484,57 | VRME040F2PD | 1.510,47 | VRME114E2PD | 1.498,27 | VRME114F2PD | 1.527,57 | 1 1/4" |
| 50 | VRME050E2PD | 1.587,36 | VRME050F2PD | 1.617,41 | VRME112E2PD | 1.604,43 | VRME112F2PD | 1.635,43 | 1 1/2" |
| 63 | VRME063E2PD | 1.624,98 | VRME063F2PD | 1.680,03 | VRME200E2PD | 1.652,51 | VRME200F2PD | 1.709,29 | 2" |

Válvula de bola REGULACIÓN motorizada en PP-H 2 vías DUAL BLOCK®. Actuación eléctrica con posicionador 4-20 mA.

Disponemos de otras conexiones bajo pedido: bridas, soldar macho y roscar (NPT) Bajo pedido podemos suministrar otros actuadores: VALPES, BELIMO... Bajo pedido también disponibles en 12 V AC/DC



VKDIM/CP

encolar.

VKDFM/CP

roscar.

ACTUACIÓN NEUMÁTICA ALUMINIO

ACTUACIÓN NEUMÁTICA ALUMINIO CON ELECTROVÁLVULA, FINALES DE CARRERA (ELECTROMECAÑICOS) Y REGULADORES DE ESCAPE



| d-Rh | DOBLE EFECTO | | SIMPLE EFECTO | | DOBLE EFECTO | | SIMPLE EFECTO | |
|--------|--------------|----------|---------------|----------|--------------|----------|---------------|----------|
| | Ref. | € | Ref. | € | Ref. | € | Ref. | € |
| 16 | VKMP016EDED | 317,89 | VKMP016ESED | 348,60 | VKMP016EDEFD | 518,55 | VKMP016ESEFD | 559,84 |
| 20 | VKMP020EDED | 318,06 | VKMP020ESED | 348,79 | VKMP020EDEFD | 518,71 | VKMP020ESEFD | 560,01 |
| 25 | VKMP025EDED | 333,85 | VKMP025ESED | 364,55 | VKMP025EDEFD | 534,45 | VKMP025ESEFD | 575,77 |
| 32 | VKMP032EDED | 353,60 | VKMP032ESED | 384,29 | VKMP032EDEFD | 554,22 | VKMP032ESEFD | 595,53 |
| 40 | VKMP040EDED | 385,68 | VKMP040ESED | 416,38 | VKMP040EDEFD | 586,28 | VKMP040ESEFD | 627,61 |
| 50 | VKMP050EDED | 423,59 | VKMP050ESED | 513,90 | VKMP050EDEFD | 624,21 | VKMP050ESEFD | 725,15 |
| 63 | VKMP063EDED | 468,29 | VKMP063ESED | 637,50 | VKMP063EDEFD | 668,91 | VKMP063ESEFD | 848,72 |
| 75 | VKMP075EDED | 797,46 | VKMP075ESED | 917,19 | VKMP075EDEFD | 998,07 | VKMP075ESEFD | 1.128,45 |
| 90 | VKMP090EDED | 925,90 | VKMP090ESED | 1.045,64 | VKMP090EDEFD | 1.126,51 | VKMP090ESEFD | 1.256,86 |
| 110 | VKMP110EDED | 1.085,16 | VKMP110ESED | 1.508,93 | VKMP110EDEFD | 1.285,80 | VKMP110ESEFD | 1.720,18 |
| 3/8" | VKMP038EDED | 330,97 | VKMP038ESED | 361,66 | VKMP038EDEFD | 531,58 | VKMP038ESEFD | 572,89 |
| 1/2" | VKMP012EDED | 330,97 | VKMP012ESED | 361,66 | VKMP012EDEFD | 531,58 | VKMP012ESEFD | 572,89 |
| 3/4" | VKMP034EDED | 344,12 | VKMP034ESED | 374,82 | VKMP034EDEFD | 544,75 | VKMP034ESEFD | 586,07 |
| 1" | VKMP100EDED | 383,73 | VKMP100ESED | 414,45 | VKMP100EDEFD | 584,35 | VKMP100ESEFD | 625,65 |
| 1 1/4" | VKMP114EDED | 399,43 | VKMP114ESED | 430,13 | VKMP114EDEFD | 600,06 | VKMP114ESEFD | 641,36 |
| 1 1/2" | VKMP112EDED | 440,66 | VKMP112ESED | 531,02 | VKMP112EDEFD | 641,31 | VKMP112ESEFD | 742,25 |
| 2" | VKMP200EDED | 495,84 | VKMP200ESED | 665,07 | VKMP200EDEFD | 696,47 | VKMP200ESEFD | 876,30 |
| 16 | VKMP016FDED | 332,69 | VKMP016FSED | 363,41 | VKMP016FDEFD | 533,31 | VKMP016FSEFD | 574,64 |
| 20 | VKMP020FDED | 332,79 | VKMP020FSED | 363,49 | VKMP020FDEFD | 533,42 | VKMP020FSEFD | 574,72 |
| 25 | VKMP025FDED | 349,36 | VKMP025FSED | 380,07 | VKMP025FDEFD | 550,00 | VKMP025FSEFD | 591,30 |
| 32 | VKMP032FDED | 376,80 | VKMP032FSED | 407,52 | VKMP032FDEFD | 577,42 | VKMP032FSEFD | 618,72 |
| 40 | VKMP040FDED | 411,62 | VKMP040FSED | 442,31 | VKMP040FDEFD | 612,26 | VKMP040FSEFD | 653,57 |
| 50 | VKMP050FDED | 453,49 | VKMP050FSED | 543,82 | VKMP050FDEFD | 654,13 | VKMP050FSEFD | 755,07 |
| 63 | VKMP063FDED | 523,27 | VKMP063FSED | 692,52 | VKMP063FDEFD | 723,94 | VKMP063FSEFD | 903,75 |
| 75 | VKMP075FDED | 927,82 | VKMP075FSED | 1.047,54 | VKMP075FDEFD | 1.128,45 | VKMP075FSEFD | 1.258,76 |
| 90 | VKMP090FDED | 1.089,74 | VKMP090FSED | 1.209,48 | VKMP090FDEFD | 1.290,38 | VKMP090FSEFD | 1.420,73 |
| 110 | VKMP110FDED | 1.248,98 | VKMP110FSED | 1.672,75 | VKMP110FDEFD | 1.449,60 | VKMP110FSEFD | 1.883,95 |
| 3/8" | VKMP038FDED | 346,49 | VKMP038FSED | 377,19 | VKMP038FDEFD | 547,12 | VKMP038FSEFD | 588,42 |
| 1/2" | VKMP012FDED | 346,49 | VKMP012FSED | 377,19 | VKMP012FDEFD | 547,12 | VKMP012FSEFD | 588,42 |
| 3/4" | VKMP034FDED | 360,55 | VKMP034FSED | 391,19 | VKMP034FDEFD | 561,14 | VKMP034FSEFD | 602,45 |
| 1" | VKMP100FDED | 400,86 | VKMP100FSED | 431,57 | VKMP100FDEFD | 601,50 | VKMP100FSEFD | 642,80 |
| 1 1/4" | VKMP114FDED | 428,63 | VKMP114FSED | 459,36 | VKMP114FDEFD | 629,28 | VKMP114FSEFD | 670,56 |
| 1 1/2" | VKMP112FDED | 471,67 | VKMP112FSED | 562,02 | VKMP112FDEFD | 672,28 | VKMP112FSEFD | 773,22 |
| 2" | VKMP200FDED | 552,54 | VKMP200FSED | 721,80 | VKMP200FDEFD | 753,19 | VKMP200FSEFD | 933,00 |

Válvula de bola motorizada

en PP-H 2 vías DUAL BLOCK®. Actuación neumática.

Disponemos de otras conexiones bajo pedido: bridas, soldar macho y roscar (NPT)

Las válvulas neumáticas se configuran NC (normalmente cerrada) de serie.

La configuración NA (normalmente abierta) se debe especificar en el pedido.

VKRIM/CP

soldar.

VKRFM/CP

roscar.

ACTUACIÓN NEUMÁTICA ALUMINIO DOBLE EFECTO
CON POSICIONADOR 4-20 mAACTUACIÓN NEUMÁTICA ALUMINIO SIMPLE EFECTO
CON POSICIONADOR 4-20 mA

| d-Rh | Ref. | € EPDM | Ref. | € FKM | Ref. | € EPDM | Ref. | € FKM |
|--------|--------------|-----------|--------------|----------|--------------|-----------|--------------|----------|
| 16 | VRMP016EDEPD | 2.325,26 | VRMP016FDEPD | 2.340,04 | VRMP016ESEPD | 2.355,97 | VRMP016FSEPD | 2.370,75 |
| 20 | VRMP020EDEPD | 2.325,41 | VRMP020FDEPD | 2.340,16 | VRMP020ESEPD | 2.356,13 | VRMP020FSEPD | 2.370,83 |
| 25 | VRMP025EDEPD | 2.359,83 | VRMP025FDEPD | 2.375,37 | VRMP025ESEPD | 2.390,51 | VRMP025FSEPD | 2.406,08 |
| 32 | VRMP032EDEPD | 2.417,54 | VRMP032FDEPD | 2.440,74 | VRMP032ESEPD | 2.448,26 | VRMP032FSEPD | 2.471,46 |
| 40 | VRMP040EDEPD | 2.470,59 | VRMP040FDEPD | 2.496,49 | VRMP040ESEPD | 2.501,30 | VRMP040FSEPD | 2.527,21 |
| 50 | VRMP050EDEPD | 2.573,35 | VRMP050FDEPD | 2.603,38 | VRMP050ESEPD | 2.663,71 | VRMP050FSEPD | 2.693,74 |
| 63 | VRMP063EDEPD | 2.611,03 | VRMP063FDEPD | 2.666,00 | VRMP063ESEPD | 2.780,23 | VRMP063FSEPD | 2.835,26 |
| 3/8" | VRMP038EDEPD | 2.338,31 | VRMP038FDEPD | 2.353,84 | VRMP038ESEPD | 2.369,03 | VRMP038FSEPD | 2.384,55 |
| 1/2" | VRMP012EDEPD | 2.338,31 | VRMP012FDEPD | 2.353,84 | VRMP012ESEPD | 2.369,03 | VRMP012FSEPD | 2.384,55 |
| 3/4" | VRMP034EDEPD | 2.370,11 | VRMP034FDEPD | 2.386,51 | VRMP034ESEPD | 2.400,81 | VRMP034FSEPD | 2.417,20 |
| 1" | VRMP100EDEPD | 2.447,62 | VRMP100FDEPD | 2.464,77 | VRMP100ESEPD | 2.478,33 | VRMP100FSEPD | 2.495,46 |
| 1 1/4" | VRMP114EDEPD | 2.484,29 | VRMP114FDEPD | 2.513,56 | VRMP114ESEPD | 2.515,00 | VRMP114FSEPD | 2.544,23 |
| 1 1/2" | VRMP112EDEPD | 2.590,45 | VRMP112FDEPD | 2.621,43 | VRMP112ESEPD | 2.680,78 | VRMP112FSEPD | 2.711,78 |
| 2" | VRMP200EDEPD | 2.638,50 | VRMP200FDEPD | 2.695,30 | VRMP200ESEPD | 2.807,76 | VRMP200FSEPD | 2.864,51 |

Válvula de bola **REGULACIÓN** motorizada
en PP-H 2 vías DUAL BLOCK®.

Actuación neumática con posicionador 4-20 mA.

Disponemos de otras conexiones bajo pedido: bridas, soldar macho y roscar (NPT)

Las válvulas neumáticas se configuran NC (normalmente cerrada) de serie.
La configuración NA (normalmente abierta) se debe especificar en el pedido.

VKRIM/CP

soldar.

VKRFM/CP

roscar.

ACTUACIÓN NEUMÁTICA POLIAMIDA DOBLE EFECTO
CON POSICIONADOR 4-20 mAACTUACIÓN NEUMÁTICA POLIAMIDA SIMPLE EFECTO
CON POSICIONADOR 4-20 mA

| d-Rh | Ref. | € EPDM | Ref. | € FKM | Ref. | € EPDM | Ref. | € FKM |
|--------|--------------|-----------|--------------|----------|--------------|-----------|--------------|----------|
| 16 | VRMP016EDEPP | 1.885,55 | VRMP016FDEPP | 1.900,35 | VRMP016ESEPP | 1.908,69 | VRMP016FSEPP | 1.923,50 |
| 20 | VRMP020EDEPP | 1.885,72 | VRMP020FDEPP | 1.900,45 | VRMP020ESEPP | 1.908,85 | VRMP020FSEPP | 1.923,61 |
| 25 | VRMP025EDEPP | 1.920,11 | VRMP025FDEPP | 1.935,66 | VRMP025ESEPP | 1.943,23 | VRMP025FSEPP | 1.958,83 |
| 32 | VRMP032EDEPP | 1.977,84 | VRMP032FDEPP | 2.001,03 | VRMP032ESEPP | 2.105,09 | VRMP032FSEPP | 2.128,29 |
| 40 | VRMP040EDEPP | 2.030,90 | VRMP040FDEPP | 2.056,81 | VRMP040ESEPP | 2.158,14 | VRMP040FSEPP | 2.184,01 |
| 50 | VRMP050EDEPP | 2.133,65 | VRMP050FDEPP | 2.163,70 | VRMP050ESEPP | 2.382,39 | VRMP050FSEPP | 2.412,39 |
| 63 | VRMP063EDEPP | 2.375,37 | VRMP063FDEPP | 2.430,39 | VRMP063ESEPP | 2.441,90 | VRMP063FSEPP | 2.496,91 |
| 3/8" | VRMP038EDEPP | 1.898,63 | VRMP038FDEPP | 1.914,15 | VRMP038ESEPP | 1.921,77 | VRMP038FSEPP | 1.937,31 |
| 1/2" | VRMP012EDEPP | 1.898,63 | VRMP012FDEPP | 1.898,63 | VRMP012ESEPP | 1.921,77 | VRMP012FSEPP | 1.937,31 |
| 3/4" | VRMP034EDEPP | 1.930,43 | VRMP034FDEPP | 1.946,78 | VRMP034ESEPP | 1.953,58 | VRMP034FSEPP | 1.969,96 |
| 1" | VRMP100EDEPP | 2.007,91 | VRMP100FDEPP | 2.025,06 | VRMP100ESEPP | 2.135,17 | VRMP100FSEPP | 2.152,29 |
| 1 1/4" | VRMP114EDEPP | 2.044,58 | VRMP114FDEPP | 2.073,88 | VRMP114ESEPP | 2.171,81 | VRMP114FSEPP | 2.201,11 |
| 1 1/2" | VRMP112EDEPP | 2.150,74 | VRMP112FDEPP | 2.181,75 | VRMP112ESEPP | 2.399,44 | VRMP112FSEPP | 2.430,44 |
| 2" | VRMP200EDEPP | 2.402,89 | VRMP200FDEPP | 2.459,64 | VRMP200ESEPP | 2.469,37 | VRMP200FSEPP | 2.526,16 |

Válvula de bola **REGULACIÓN** motorizada
en PP-H 2 vías DUAL BLOCK®.

Actuación neumática con posicionador 4-20 mA.

Disponemos de otras conexiones bajo pedido: bridas, soldar macho y roscar (NPT)

Las válvulas neumáticas se configuran NC (normalmente cerrada) de serie.
La configuración NA (normalmente abierta) se debe especificar en el pedido.



VKDIM/CP

soldar.

VKDFM/CP

roscar.

ACTUACIÓN NEUMÁTICA POLIAMIDA

ACTUACIÓN NEUMÁTICA POLIAMIDA CON ELECTROVÁLVULA, FINALES DE CARRERA (ELECTROMECAÑICOS) Y REGULADORES DE ESCAPE

| d-Rh | DOBLE EFECTO | | SIMPLE EFECTO | | DOBLE EFECTO | | SIMPLE EFECTO | |
|------|--------------|----------|---------------|----------|--------------|----------|---------------|----------|
| | Ref. | € | Ref. | € | Ref. | € | Ref. | € |
| 16 | VKMP016EDEP | 336,63 | VKMP016ESEP | 359,78 | VKMP016EDEFP | 599,08 | VKMP016ESEFP | 622,22 |
| 20 | VKMP020EDEP | 336,81 | VKMP020ESEP | 359,93 | VKMP020EDEFP | 599,25 | VKMP020ESEFP | 622,38 |
| 25 | VKMP025EDEP | 352,55 | VKMP025ESEP | 375,69 | VKMP025EDEFP | 614,99 | VKMP025ESEFP | 638,14 |
| 32 | VKMP032EDEP | 372,35 | VKMP032ESEP | 499,58 | VKMP032EDEFP | 634,77 | VKMP032ESEFP | 762,02 |
| 40 | VKMP040EDEP | 404,41 | VKMP040ESEP | 531,67 | VKMP040EDEFP | 666,82 | VKMP040ESEFP | 794,11 |
| 50 | VKMP050EDEP | 442,31 | VKMP050ESEP | 691,03 | VKMP050EDEFP | 704,78 | VKMP050ESEFP | 953,47 |
| 63 | VKMP063EDEP | 691,08 | VKMP063ESEP | 757,60 | VKMP063EDEFP | 953,52 | VKMP063ESEFP | 1.020,01 |
| 75 | VKMP075EDEP | 926,49 | VKMP075ESEP | 1.175,64 | VKMP075EDEFP | 1.188,91 | VKMP075ESEFP | 1.438,07 |
| 90 | VKMP090EDEP | 1.054,93 | VKMP090ESEP | 1.304,06 | VKMP090EDEFP | 1.317,37 | VKMP090ESEFP | 1.566,53 |
| 110 | VKMP110EDEP | 1.180,82 | VKMP110ESEP | 1.451,20 | VKMP110EDEFP | 1.443,24 | VKMP110ESEFP | 1.713,64 |

| | | | | | | | | |
|--------|-------------|--------|-------------|--------|--------------|--------|--------------|----------|
| 3/8" | VKMP038EDEP | 349,69 | VKMP038ESEP | 372,84 | VKMP038EDEFP | 612,16 | VKMP038ESEFP | 635,30 |
| 1/2" | VKMP012EDEP | 349,69 | VKMP012ESEP | 372,84 | VKMP012EDEFP | 612,16 | VKMP012ESEFP | 635,30 |
| 3/4" | VKMP034EDEP | 362,90 | VKMP034ESEP | 386,02 | VKMP034EDEFP | 625,31 | VKMP034ESEFP | 648,47 |
| 1" | VKMP100EDEP | 402,45 | VKMP100ESEP | 529,71 | VKMP100EDEFP | 664,90 | VKMP100ESEFP | 792,15 |
| 1 1/4" | VKMP114EDEP | 418,18 | VKMP114ESEP | 545,42 | VKMP114EDEFP | 680,62 | VKMP114ESEFP | 807,83 |
| 1 1/2" | VKMP112EDEP | 459,41 | VKMP112ESEP | 708,10 | VKMP112EDEFP | 721,85 | VKMP112ESEFP | 970,55 |
| 2" | VKMP200EDEP | 718,63 | VKMP200ESEP | 785,15 | VKMP200EDEFP | 981,08 | VKMP200ESEFP | 1.047,59 |

| | | | | | | | | |
|-----|-------------|----------|-------------|----------|--------------|----------|--------------|----------|
| 16 | VKMP016FDEP | 351,42 | VKMP016FSEP | 374,56 | VKMP016FDEFP | 613,86 | VKMP016FSEFP | 637,00 |
| 20 | VKMP020FDEP | 351,54 | VKMP020FSEP | 374,66 | VKMP020FDEFP | 613,98 | VKMP020FSEFP | 637,14 |
| 25 | VKMP025FDEP | 368,10 | VKMP025FSEP | 391,19 | VKMP025FDEFP | 630,55 | VKMP025FSEFP | 653,67 |
| 32 | VKMP032FDEP | 395,55 | VKMP032FSEP | 522,76 | VKMP032FDEFP | 657,96 | VKMP032FSEFP | 785,22 |
| 40 | VKMP040FDEP | 430,36 | VKMP040FSEP | 557,59 | VKMP040FDEFP | 692,81 | VKMP040FSEFP | 820,01 |
| 50 | VKMP050FDEP | 472,23 | VKMP050FSEP | 720,93 | VKMP050FDEFP | 734,68 | VKMP050FSEFP | 983,37 |
| 63 | VKMP063FDEP | 746,11 | VKMP063FSEP | 812,60 | VKMP063FDEFP | 1.008,50 | VKMP063FSEFP | 1.075,04 |
| 75 | VKMP075FDEP | 1.056,81 | VKMP075FSEP | 1.305,94 | VKMP075FDEFP | 1.319,25 | VKMP075FSEFP | 1.568,38 |
| 90 | VKMP090FDEP | 1.218,78 | VKMP090FSEP | 1.467,94 | VKMP090FDEFP | 1.481,24 | VKMP090FSEFP | 1.730,35 |
| 110 | VKMP110FDEP | 1.344,56 | VKMP110FSEP | 1.614,99 | VKMP110FDEFP | 1.607,01 | VKMP110FSEFP | 1.877,43 |

| | | | | | | | | |
|--------|-------------|--------|-------------|--------|--------------|----------|--------------|----------|
| 3/8" | VKMP038FDEP | 365,24 | VKMP038FSEP | 388,36 | VKMP038FDEFP | 627,66 | VKMP038FSEFP | 650,81 |
| 1/2" | VKMP012FDEP | 349,69 | VKMP012FSEP | 388,36 | VKMP012FDEFP | 612,16 | VKMP012FSEFP | 650,81 |
| 3/4" | VKMP034FDEP | 379,25 | VKMP034FSEP | 402,37 | VKMP034FDEFP | 641,72 | VKMP034FSEFP | 664,84 |
| 1" | VKMP100FDEP | 419,60 | VKMP100FSEP | 546,83 | VKMP100FDEFP | 682,05 | VKMP100FSEFP | 809,27 |
| 1 1/4" | VKMP114FDEP | 447,36 | VKMP114FSEP | 574,64 | VKMP114FDEFP | 709,82 | VKMP114FSEFP | 837,06 |
| 1 1/2" | VKMP112FDEP | 490,38 | VKMP112FSEP | 739,08 | VKMP112FDEFP | 752,83 | VKMP112FSEFP | 1.001,52 |
| 2" | VKMP200FDEP | 775,33 | VKMP200FSEP | 841,87 | VKMP200FDEFP | 1.037,81 | VKMP200FSEFP | 1.104,31 |

Válvula de bola motorizada

en PP-H 2 vías DUAL BLOCK®. Actuación neumática.

Disponemos de otras conexiones bajo pedido: bridas, soldar macho y roscar (NPT)

Las válvulas neumáticas se configuran NC (normalmente cerrada) de serie. La configuración NA (normalmente abierta) se debe especificar en el pedido.



INDUSTRIA

Sistema PP-H Socket

Válvulas de 3 vías actuadas



LKDIM/CE
soldar.

LKDFM/CE
rosacar.

ACTUACIÓN ELÉCTRICA

ACTUACIÓN ELÉCTRICA CON BLOQUE DE SEGURIDAD

| d-Rh | 24-240 V AC/DC | | 24-240 V AC/DC | | 24-240 V AC/DC | | 24-240 V AC/DC | |
|--------|----------------|----------|----------------|----------|----------------|----------|----------------|----------|
| | Ref. | € | Ref. | € | Ref. | € | Ref. | € |
| 20 | LKME020E2D | 733,70 | LKME020F2D | 750,30 | LKME020E2BD | 1.288,38 | LKME020F2BD | 1.304,99 |
| 25 | LKME025E2D | 755,54 | LKME025F2D | 777,08 | LKME025E2BD | 1.310,19 | LKME025F2BD | 1.331,74 |
| 32 | LKME032E2D | 803,19 | LKME032F2D | 830,88 | LKME032E2BD | 1.357,88 | LKME032F2BD | 1.385,54 |
| 40 | LKME040E2D | 841,82 | LKME040F2D | 879,70 | LKME040E2BD | 1.396,50 | LKME040F2BD | 1.434,36 |
| 50 | LKME050E2D | 889,77 | LKME050F2D | 951,98 | LKME050E2BD | 1.444,42 | LKME050F2BD | 1.506,63 |
| 63 | LKME063E2D | 971,50 | LKME063F2D | 1.050,22 | LKME063E2BD | 1.526,20 | LKME063F2BD | 1.604,87 |
| 1/2" | LKME012E2D | 748,14 | LKME012F2D | 764,78 | LKME012E2BD | 1.302,83 | LKME012F2BD | 1.319,43 |
| 3/4" | LKME034E2D | 772,04 | LKME034F2D | 793,56 | LKME034E2BD | 1.326,72 | LKME034F2BD | 1.348,25 |
| 1" | LKME100E2D | 824,39 | LKME100F2D | 852,07 | LKME100E2BD | 1.379,07 | LKME100F2BD | 1.406,75 |
| 1 1/4" | LKME114E2D | 866,57 | LKME114F2D | 904,49 | LKME114E2BD | 1.421,22 | LKME114F2BD | 1.459,15 |
| 1 1/2" | LKME112E2D | 920,92 | LKME112F2D | 983,08 | LKME112E2BD | 1.475,61 | LKME112F2BD | 1.537,77 |
| 2" | LKME200E2D | 1.010,87 | LKME200F2D | 1.089,53 | LKME200E2BD | 1.565,53 | LKME200F2BD | 1.644,19 |

Válvula de bola motorizada en PP-H 3 vías DUAL BLOCK®.

Estándar paso en L, paso en T opcional, al mismo precio. Bajo pedido podemos suministrar otros actuadores: VALPES, BELIMO...

Disponemos de otras conexiones bajo pedido: bridas, soldar macho y rosacar (NPT).

Bajo pedido también disponibles en 12 V AC/DC

Actuación eléctrica.

LKDIM/CP

soldar.

LKDFM/CP

roscar.

ACTUACIÓN NEUMÁTICA ALUMINIO

ACTUACIÓN NEUMÁTICA ALUMINIO CON ELECTROVÁLVULA, FINALES DE CARRERA (ELECTROMECAÑICOS) Y REGULADORES DE ESCAPE



| d-Rh | DOBLE EFECTO | | SIMPLE EFECTO | | DOBLE EFECTO | | SIMPLE EFECTO | |
|------|--------------|--------|---------------|--------|--------------|--------|---------------|----------|
| | Ref. | € | Ref. | € | Ref. | € | Ref. | € |
| 20 | LKMP020EDED | 396,34 | LKMP020ESED | 427,02 | LKMP020EDEFD | 596,97 | LKMP020ESEFD | 638,27 |
| 25 | LKMP025EDED | 418,18 | LKMP025ESED | 448,85 | LKMP025EDEFD | 618,77 | LKMP025ESEFD | 660,11 |
| 32 | LKMP032EDED | 465,85 | LKMP032ESED | 496,51 | LKMP032EDEFD | 666,44 | LKMP032ESEFD | 707,74 |
| 40 | LKMP040EDED | 504,44 | LKMP040ESED | 594,77 | LKMP040EDEFD | 705,09 | LKMP040ESEFD | 806,01 |
| 50 | LKMP050EDED | 588,13 | LKMP050ESED | 721,60 | LKMP050EDEFD | 788,77 | LKMP050ESEFD | 932,85 |
| 63 | LKMP063EDED | 669,89 | LKMP063ESED | 803,38 | LKMP063EDEFD | 870,50 | LKMP063ESEFD | 1.014,60 |

| | | | | | | | | |
|--------|-------------|--------|-------------|--------|--------------|--------|--------------|----------|
| 1/2" | LKMP012EDED | 410,76 | LKMP012ESED | 441,49 | LKMP012EDEFD | 611,41 | LKMP012ESEFD | 652,71 |
| 3/4" | LKMP034EDED | 434,66 | LKMP034ESED | 465,38 | LKMP034EDEFD | 635,30 | LKMP034ESEFD | 676,59 |
| 1" | LKMP100EDED | 487,01 | LKMP100ESED | 517,73 | LKMP100EDEFD | 687,63 | LKMP100ESEFD | 728,96 |
| 1 1/4" | LKMP114EDED | 529,19 | LKMP114ESED | 619,52 | LKMP114EDEFD | 729,81 | LKMP114ESEFD | 830,75 |
| 1 1/2" | LKMP112EDED | 619,29 | LKMP112ESED | 752,78 | LKMP112EDEFD | 819,91 | LKMP112ESEFD | 964,01 |
| 2" | LKMP200EDED | 709,24 | LKMP200ESED | 842,73 | LKMP200EDEFD | 909,85 | LKMP200ESEFD | 1.053,95 |

| | | | | | | | | |
|----|-------------|--------|-------------|--------|--------------|--------|--------------|----------|
| 20 | LKMP020FDED | 412,93 | LKMP020FSED | 443,65 | LKMP020FDEFD | 613,57 | LKMP020FSEFD | 654,90 |
| 25 | LKMP025FDED | 439,71 | LKMP025FSED | 470,40 | LKMP025FDEFD | 640,35 | LKMP025FSEFD | 681,63 |
| 32 | LKMP032FDED | 493,47 | LKMP032FSED | 524,20 | LKMP032FDEFD | 694,12 | LKMP032FSEFD | 735,42 |
| 40 | LKMP040FDED | 542,33 | LKMP040FSED | 632,66 | LKMP040FDEFD | 742,94 | LKMP040FSEFD | 843,88 |
| 50 | LKMP050FDED | 650,37 | LKMP050FSED | 783,83 | LKMP050FDEFD | 850,99 | LKMP050FSEFD | 995,06 |
| 63 | LKMP063FDED | 748,58 | LKMP063FSED | 882,07 | LKMP063FDEFD | 949,23 | LKMP063FSEFD | 1.093,29 |

| | | | | | | | | |
|--------|-------------|--------|-------------|--------|--------------|--------|--------------|----------|
| 1/2" | LKMP012FDED | 427,38 | LKMP012FSED | 458,09 | LKMP012FDEFD | 628,02 | LKMP012FSEFD | 669,29 |
| 3/4" | LKMP034FDED | 456,19 | LKMP034FSED | 486,91 | LKMP034FDEFD | 656,81 | LKMP034FSEFD | 698,13 |
| 1" | LKMP100FDED | 514,67 | LKMP100FSED | 545,42 | LKMP100FDEFD | 715,31 | LKMP100FSEFD | 756,62 |
| 1 1/4" | LKMP114FDED | 567,12 | LKMP114FSED | 657,45 | LKMP114FDEFD | 767,74 | LKMP114FSEFD | 868,68 |
| 1 1/2" | LKMP112FDED | 681,48 | LKMP112FSED | 814,94 | LKMP112FDEFD | 882,07 | LKMP112FSEFD | 1.026,17 |
| 2" | LKMP200FDED | 787,90 | LKMP200FSED | 921,39 | LKMP200FDEFD | 988,54 | LKMP200FSEFD | 1.132,59 |

Válvula de bola motorizada en PP-H 3 vías DUAL BLOCK®. Actuación neumática.

Estándar paso en L, paso en T opcional al mismo precio. Disponemos de otras conexiones bajo pedido: bridas, soldar macho y roscar (NPT). Las válvulas neumáticas se configuran NC (normalmente cerrada) de serie. La configuración NA (normalmente abierta) se debe especificar en el pedido.

LKDIM/CP

soldar.

LKDFM/CP

roscar.

ACTUACIÓN NEUMÁTICA POLIAMIDA

ACTUACIÓN NEUMÁTICA POLIAMIDA CON ELECTROVÁLVULA, FINALES DE CARRERA (ELECTROMECAÑICOS) Y REGULADORES DE ESCAPE



| d-Rh | DOBLE EFECTO | | SIMPLE EFECTO | | DOBLE EFECTO | | SIMPLE EFECTO | |
|------|--------------|--------|---------------|--------|--------------|----------|---------------|----------|
| | Ref. | € | Ref. | € | Ref. | € | Ref. | € |
| 20 | LKMP020EDEP | 454,49 | LKMP020ESEP | 477,64 | LKMP020EDEF | 716,91 | LKMP020ESEFP | 740,06 |
| 25 | LKMP025EDEP | 521,52 | LKMP025ESEP | 544,64 | LKMP025EDEF | 783,96 | LKMP025ESEFP | 807,09 |
| 32 | LKMP032EDEP | 569,18 | LKMP032ESEP | 696,38 | LKMP032EDEF | 831,62 | LKMP032ESEFP | 958,83 |
| 40 | LKMP040EDEP | 622,67 | LKMP040ESEP | 871,38 | LKMP040EDEF | 885,13 | LKMP040ESEFP | 1.133,80 |
| 50 | LKMP050EDEP | 763,62 | LKMP050ESEP | 916,83 | LKMP050EDEF | 1.026,07 | LKMP050ESEFP | 1.179,30 |
| 63 | LKMP063EDEP | 921,52 | LKMP063ESEP | 988,03 | LKMP063EDEF | 1.183,93 | LKMP063ESEFP | 1.250,47 |

| | | | | | | | | |
|--------|-------------|--------|-------------|----------|-------------|----------|--------------|----------|
| 1/2" | LKMP012EDEP | 468,91 | LKMP012ESEP | 492,06 | LKMP012EDEF | 731,35 | LKMP012ESEFP | 754,51 |
| 3/4" | LKMP034EDEP | 538,02 | LKMP034ESEP | 561,14 | LKMP034EDEF | 800,46 | LKMP034ESEFP | 823,59 |
| 1" | LKMP100EDEP | 590,38 | LKMP100ESEP | 717,63 | LKMP100EDEF | 852,82 | LKMP100ESEFP | 980,05 |
| 1 1/4" | LKMP114EDEP | 647,44 | LKMP114ESEP | 896,10 | LKMP114EDEF | 909,85 | LKMP114ESEFP | 1.158,57 |
| 1 1/2" | LKMP112EDEP | 794,78 | LKMP112ESEP | 948,01 | LKMP112EDEF | 1.057,22 | LKMP112ESEFP | 1.210,46 |
| 2" | LKMP200EDEP | 960,84 | LKMP200ESEP | 1.027,40 | LKMP200EDEF | 1.223,31 | LKMP200ESEFP | 1.289,82 |

| | | | | | | | | |
|----|-------------|----------|-------------|----------|-------------|----------|--------------|----------|
| 20 | LKMP020FDEP | 471,07 | LKMP020FSEP | 494,22 | LKMP020FDEF | 733,55 | LKMP020FSEFP | 756,69 |
| 25 | LKMP025FDEP | 543,05 | LKMP025FSEP | 566,17 | LKMP025FDEF | 805,49 | LKMP025FSEFP | 828,64 |
| 32 | LKMP032FDEP | 596,83 | LKMP032FSEP | 724,09 | LKMP032FDEF | 859,28 | LKMP032FSEFP | 986,53 |
| 40 | LKMP040FDEP | 660,54 | LKMP040FSEP | 909,26 | LKMP040FDEF | 922,98 | LKMP040FSEFP | 1.171,68 |
| 50 | LKMP050FDEP | 825,83 | LKMP050FSEP | 979,07 | LKMP050FDEF | 1.088,28 | LKMP050FSEFP | 1.241,51 |
| 63 | LKMP063FDEP | 1.000,21 | LKMP063FSEP | 1.066,72 | LKMP063FDEF | 1.262,66 | LKMP063FSEFP | 1.329,16 |

| | | | | | | | | |
|--------|-------------|----------|-------------|----------|-------------|----------|--------------|----------|
| 1/2" | LKMP012FDEP | 485,54 | LKMP012FSEP | 508,67 | LKMP012FDEF | 747,99 | LKMP012FSEFP | 771,14 |
| 3/4" | LKMP034FDEP | 559,55 | LKMP034FSEP | 582,67 | LKMP034FDEF | 821,99 | LKMP034FSEFP | 845,12 |
| 1" | LKMP100FDEP | 618,03 | LKMP100FSEP | 745,29 | LKMP100FDEF | 880,47 | LKMP100FSEFP | 1.007,73 |
| 1 1/4" | LKMP114FDEP | 685,36 | LKMP114FSEP | 934,06 | LKMP114FDEF | 947,81 | LKMP114FSEFP | 1.196,48 |
| 1 1/2" | LKMP112FDEP | 856,94 | LKMP112FSEP | 1.010,17 | LKMP112FDEF | 1.119,38 | LKMP112FSEFP | 1.272,62 |
| 2" | LKMP200FDEP | 1.039,51 | LKMP200FSEP | 1.106,04 | LKMP200FDEF | 1.301,95 | LKMP200FSEFP | 1.368,46 |

Válvula de bola motorizada en PP-H 3 vías DUAL BLOCK®. Actuación neumática.

Estándar paso en L, paso en T opcional, al mismo precio. Disponemos de otras conexiones bajo pedido: bridas, soldar macho y roscar (NPT). Las válvulas neumáticas se configuran NC (normalmente cerrada) de serie. La configuración NA (normalmente abierta) se debe especificar en el pedido.



INDUSTRIA

Sistema PP-H Socket

Válvulas de mariposa actuadas



FKOM/CE

ACTUACIÓN ELÉCTRICA**ACTUACIÓN ELÉCTRICA CON BLOQUE DE SEGURIDAD**

| d | 24-240 V AC/DC | | 24-240 V AC/DC | | 24-240 V AC/DC | | 24-240 V AC/DC | |
|-----|----------------|-----------|----------------|-----------|----------------|-----------|----------------|----------|
| | Ref. | € EPDM | Ref. | € FKM | Ref. | € EPDM | Ref. | € FKM |
| 50 | FKME050E2D | 874,57 | FKME050F2D | 1.039,99 | FKME050E2BD | 1.429,26 | FKME050F2BD | 1.594,63 |
| 63 | FKME063E2D | 893,78 | FKME063F2D | 1.068,91 | FKME063E2BD | 1.448,44 | FKME063F2BD | 1.623,57 |
| 75 | FKME075E2D | 1.191,71 | FKME075F2D | 1.386,28 | FKME075E2BD | 1.746,42 | FKME075F2BD | 1.940,96 |
| 90 | FKME090E2D | 1.225,13 | FKME090F2D | 1.428,43 | FKME090E2BD | 1.779,79 | FKME090F2BD | 1.983,14 |
| 110 | FKME110E2D | 1.261,44 | FKME110F2D | 1.471,95 | FKME110E2BD | 1.816,13 | FKME110F2BD | 2.026,61 |
| 125 | FKME140E2D | 1.775,41 | FKME140F2D | 2.062,83 | FKME140E2BD | 2.330,07 | FKME140F2BD | 2.617,57 |
| 140 | FKME140E2D | 1.775,41 | FKME140F2D | 2.062,83 | FKME140E2BD | 2.330,07 | FKME140F2BD | 2.617,57 |
| 160 | FKME160E2D | 2.079,70 | FKME160F2D | 2.370,16 | FKME160E2BD | 2.728,78 | FKME160F2BD | 3.019,27 |
| 200 | FKME225E2D | 2.419,62 | FKME225F2D | 2.798,56 | FKME225E2BD | 3.068,68 | FKME225F2BD | 3.447,67 |
| 225 | FKME225E2D | 2.419,62 | FKME225F2D | 2.798,56 | FKME225E2BD | 3.068,68 | FKME225F2BD | 3.447,67 |
| 250 | FKME280E2D | 4.373,41 | FKME280F2D | 6.066,58 | FKME280E2BD | 5.022,49 | FKME280F2BD | 6.715,65 |
| 280 | FKME280E2D | 4.373,41 | FKME280F2D | 6.066,58 | FKME280E2BD | 5.022,49 | FKME280F2BD | 6.715,65 |
| 315 | FKME315E2D | 4.621,69 | FKME315F2D | 6.467,42 | FKME315E2BD | 5.270,77 | FKME315F2BD | 7.116,51 |
| 355 | FKME355E2D | 11.072,32 | FKME355F2D | 15.002,86 | | | | |
| 400 | FKME400E2D | 12.353,54 | FKME400F2D | 18.026,78 | | | | |

Válvula de mariposa motorizada
cuerpo en PPGR y disco en PP-H.
Actuación eléctrica.

Bajo pedido podemos suministrar otros actuadores: VALPES, BELIMO...
Bajo pedido también disponibles en 12 V AC/DC



FKOM/CP

ACTUACIÓN NEUMÁTICA ALUMINIO

ACTUACIÓN NEUMÁTICA ALUMINIO CON ELECTROVÁLVULA, FINALES DE CARRERA (ELECTROMECAÑICOS) Y REGULADORES DE ESCAPE

| d | DOBLE EFECTO | | SIMPLE EFECTO | | DOBLE EFECTO | | SIMPLE EFECTO | |
|-----|--------------|----------|---------------|-----------|--------------|----------|---------------|----------|
| | Ref. | € | Ref. | € | Ref. | € | Ref. | € |
| 50 | FKMP050EDED | 536,84 | FKMP050ESED | 627,22 | FKMP050EDEFD | 737,48 | FKMP050ESEFD | 838,45 |
| 63 | FKMP063EDED | 556,05 | FKMP063ESED | 646,41 | FKMP063EDEFD | 756,69 | FKMP063ESEFD | 857,61 |
| 75 | FKMP075EDED | 630,13 | FKMP075ESED | 763,62 | FKMP075EDEFD | 830,75 | FKMP075ESEFD | 974,82 |
| 90 | FKMP090EDED | 726,08 | FKMP090ESED | 845,82 | FKMP090EDEFD | 926,69 | FKMP090ESEFD | 1.057,04 |
| 110 | FKMP110EDED | 762,44 | FKMP110ESED | 1.213,16 | FKMP110EDEFD | 963,03 | FKMP110ESEFD | 1.424,39 |
| 125 | FKMP140EDED | 943,20 | FKMP140ESED | 1.620,60 | FKMP140EDEFD | 1.143,85 | FKMP140ESEFD | 1.831,83 |
| 140 | FKMP140EDED | 943,20 | FKMP140ESED | 1.620,60 | FKMP140EDEFD | 1.143,85 | FKMP140ESEFD | 1.831,83 |
| 160 | FKMP160EDED | 1.005,62 | FKMP160ESED | 1.682,97 | FKMP160EDEFD | 1.206,23 | FKMP160ESEFD | 1.894,20 |
| 200 | FKMP225EDED | 1.484,42 | FKMP225ESED | 2.414,11 | FKMP225EDEFD | 1.685,06 | FKMP225ESEFD | 2.625,32 |
| 225 | FKMP225EDED | 1.484,42 | FKMP225ESED | 2.414,11 | FKMP225EDEFD | 1.685,06 | FKMP225ESEFD | 2.625,32 |
| 250 | FKMP280EDED | 3.619,14 | FKMP280ESED | 5.590,10 | FKMP280EDEFD | 3.819,73 | FKMP280ESEFD | 5.801,35 |
| 280 | FKMP280EDED | 3.619,14 | FKMP280ESED | 5.590,10 | FKMP280EDEFD | 3.819,73 | FKMP280ESEFD | 5.801,35 |
| 315 | FKMP315EDED | 4.135,45 | FKMP315ESED | 6.856,59 | FKMP315EDEFD | 4.336,09 | FKMP315ESEFD | 7.067,84 |
| 355 | FKMP355EDED | 6.340,47 | FKMP355ESED | 8.391,08 | | | | |
| 400 | FKMP400EDED | 7.085,09 | FKMP400ESED | 10.986,78 | | | | |

| | | | | | | | | |
|-----|-------------|-----------|-------------|-----------|--------------|----------|--------------|----------|
| 50 | FKMP050FDED | 702,25 | FKMP050FSED | 792,59 | FKMP050EDEFD | 737,48 | FKMP050FSEFD | 1.003,82 |
| 63 | FKMP063FDED | 731,20 | FKMP063FSED | 821,56 | FKMP063EDEFD | 756,69 | FKMP063FSEFD | 1.032,76 |
| 75 | FKMP075FDED | 824,70 | FKMP075FSED | 958,16 | FKMP075EDEFD | 830,75 | FKMP075FSEFD | 1.169,36 |
| 90 | FKMP090FDED | 929,40 | FKMP090FSED | 1.049,14 | FKMP090EDEFD | 926,69 | FKMP090FSEFD | 1.260,39 |
| 110 | FKMP110FDED | 972,89 | FKMP110FSED | 1.423,61 | FKMP110EDEFD | 963,03 | FKMP110FSEFD | 1.634,85 |
| 125 | FKMP140FDED | 1.230,67 | FKMP140FSED | 1.908,08 | FKMP140EDEFD | 1.143,85 | FKMP140FSEFD | 2.119,31 |
| 140 | FKMP140FDED | 1.230,67 | FKMP140FSED | 1.908,08 | FKMP140EDEFD | 1.143,85 | FKMP140FSEFD | 2.119,31 |
| 160 | FKMP160FDED | 1.296,05 | FKMP160FSED | 1.973,43 | FKMP160EDEFD | 1.206,23 | FKMP160FSEFD | 2.184,68 |
| 200 | FKMP225FDED | 1.863,37 | FKMP225FSED | 2.793,08 | FKMP225EDEFD | 1.685,06 | FKMP225FSEFD | 3.004,28 |
| 225 | FKMP225FDED | 1.863,37 | FKMP225FSED | 2.793,08 | FKMP225EDEFD | 1.685,06 | FKMP225FSEFD | 3.004,28 |
| 250 | FKMP280FDED | 5.312,31 | FKMP280FSED | 7.283,28 | FKMP280EDEFD | 3.819,73 | FKMP280FSEFD | 7.494,52 |
| 280 | FKMP280FDED | 5.312,31 | FKMP280FSED | 7.283,28 | FKMP280EDEFD | 3.819,73 | FKMP280FSEFD | 7.494,52 |
| 315 | FKMP315FDED | 5.981,24 | FKMP315FSED | 8.702,32 | FKMP315EDEFD | 4.336,09 | FKMP315FSEFD | 8.913,57 |
| 355 | FKMP355FDED | 10.271,01 | FKMP355FSED | 12.321,61 | | | | |
| 400 | FKMP400FDED | 12.758,33 | FKMP400FSED | 16.660,07 | | | | |

Válvula de mariposa motorizada cuerpo en PPGR y disco en PP-H.
 Actuación neumática.

Las válvulas neumáticas se configuran NC (normalmente cerrada) de serie.
 La configuración NA (normalmente abierta) se debe especificar en el pedido.



FKOM/CP

ACTUACIÓN NEUMÁTICA POLIAMIDA

ACTUACIÓN NEUMÁTICA POLIAMIDA CON ELECTROVÁLVULA, FINALES DE CARRERA (ELECTROMECÁNICOS) Y REGULADORES DE ESCAPE

| d | DOBLE EFECTO | | SIMPLE EFECTO | | DOBLE EFECTO | | SIMPLE EFECTO | |
|------|--------------|-----------|---------------|-----------|--------------|----------|---------------|----------|
| | Ref. | € | Ref. | € | Ref. | € | Ref. | € |
| 50 | FKMP050EDEP | 643,83 | FKMP050ESEP | 806,98 | FKMP050EDEFP | 906,25 | FKMP050ESEFP | 1.069,43 |
| 63 | FKMP063EDEP | 663,01 | FKMP063ESEP | 826,16 | FKMP063EDEFP | 925,46 | FKMP063ESEFP | 1.088,61 |
| 75 | FKMP075EDEP | 701,33 | FKMP075ESEP | 864,48 | FKMP075EDEFP | 963,77 | FKMP075ESEFP | 1.126,92 |
| 90 | FKMP090EDEP | 831,03 | FKMP090ESEP | 897,52 | FKMP090EDEFP | 1.093,48 | FKMP090ESEFP | 1.159,99 |
| 110 | FKMP110EDEP | 867,36 | FKMP110ESEP | 1.129,12 | FKMP110EDEFP | 1.129,81 | FKMP110ESEFP | 1.391,56 |
| 125 | FKMP140EDEP | 1.006,88 | FKMP140ESEP | 1.568,74 | FKMP140EDEFP | 1.269,32 | FKMP140ESEFP | 1.831,19 |
| 140 | FKMP140EDEP | 1.006,88 | FKMP140ESEP | 1.568,74 | FKMP140EDEFP | 1.269,32 | FKMP140ESEFP | 1.831,19 |
| 160 | FKMP160EDEP | 1.252,84 | FKMP160ESEP | 1.631,14 | FKMP160EDEFP | 1.515,28 | FKMP160ESEFP | 1.893,58 |
| 200 | FKMP225EDEP | 1.465,82 | FKMP225ESEP | 2.246,48 | FKMP225EDEFP | 1.728,27 | FKMP225ESEFP | 2.508,93 |
| 225 | FKMP225EDEP | 1.465,82 | FKMP225ESEP | 2.246,48 | FKMP225EDEFP | 1.728,27 | FKMP225ESEFP | 2.508,93 |
| 250* | FKMP280EDEP | 3.797,82 | FKMP280ESEP | 5.471,34 | FKMP280EDEFP | 4.060,26 | FKMP280ESEFP | 5.733,78 |
| 280* | FKMP280EDEP | 3.797,82 | FKMP280ESEP | 5.471,34 | FKMP280EDEFP | 4.060,26 | FKMP280ESEFP | 5.733,78 |
| 315* | FKMP315EDEP | 4.046,10 | FKMP315ESEP | 5.719,64 | FKMP315EDEFP | 4.308,54 | FKMP315ESEFP | 5.982,09 |
| 355 | FKMP355EDEP | Consultar | FKMP355ESEP | Consultar | | | | |
| 400 | FKMP400EDEP | Consultar | FKMP400ESEP | Consultar | | | | |

| | | | | | | | | |
|------|-------------|-----------|-------------|-----------|--------------|----------|--------------|----------|
| 50 | FKMP050FDEP | 809,22 | FKMP050FSEP | 972,37 | FKMP050FDEFP | 1.071,66 | FKMP050FSEFP | 1.234,82 |
| 63 | FKMP063FDEP | 838,14 | FKMP063FSEP | 1.001,29 | FKMP063FDEFP | 1.100,56 | FKMP063FSEFP | 1.263,76 |
| 75 | FKMP075FDEP | 895,89 | FKMP075FSEP | 1.059,05 | FKMP075FDEFP | 1.158,34 | FKMP075FSEFP | 1.321,49 |
| 90 | FKMP090FDEP | 1.034,36 | FKMP090FSEP | 1.100,86 | FKMP090FDEFP | 1.296,82 | FKMP090FSEFP | 1.363,31 |
| 110 | FKMP110FDEP | 1.077,84 | FKMP110FSEP | 1.339,60 | FKMP110FDEFP | 1.340,29 | FKMP110FSEFP | 1.602,04 |
| 125 | FKMP140FDEP | 1.294,33 | FKMP140FSEP | 1.856,19 | FKMP140FDEFP | 1.556,77 | FKMP140FSEFP | 2.118,66 |
| 140 | FKMP140FDEP | 1.294,33 | FKMP140FSEP | 1.856,19 | FKMP140FDEFP | 1.556,77 | FKMP140FSEFP | 2.118,66 |
| 160 | FKMP160FDEP | 1.543,33 | FKMP160FSEP | 1.921,60 | FKMP160FDEFP | 1.805,74 | FKMP160FSEFP | 2.184,01 |
| 200 | FKMP225FDEP | 1.844,78 | FKMP225FSEP | 2.625,45 | FKMP225FDEFP | 2.107,23 | FKMP225FSEFP | 2.887,89 |
| 225 | FKMP225FDEP | 1.844,78 | FKMP225FSEP | 2.625,45 | FKMP225FDEFP | 2.107,23 | FKMP225FSEFP | 2.887,89 |
| 250* | FKMP280FDEP | 5.490,98 | FKMP280FSEP | 7.164,53 | FKMP280FDEFP | 5.753,43 | FKMP280FSEFP | 7.426,97 |
| 280* | FKMP280FDEP | 5.490,98 | FKMP280FSEP | 7.164,53 | FKMP280FDEFP | 5.753,43 | FKMP280FSEFP | 7.426,97 |
| 315* | FKMP315FDEP | 5.891,84 | FKMP315FSEP | 7.565,38 | FKMP315FDEFP | 6.154,28 | FKMP315FSEFP | 7.827,82 |
| 355 | FKMP355FDEP | Consultar | FKMP355FSEP | Consultar | | | | |
| 400 | FKMP400FDEP | Consultar | FKMP400FSEP | Consultar | | | | |

Válvula de mariposa motorizada cuerpo en PPGR y disco en PP-H.
 Actuación neumática.

Las válvulas neumáticas se configuran NC (normalmente cerrada) de serie.
 La configuración NA (normalmente abierta) se debe especificar en el pedido
 * Actuadores de aluminio.



Sistema PP-H Socket

Válvulas de membrana actuadas



DK/CP NC

| d | Modelo | DN | Ref. EPDM | € EPDM |
|-----|------------|-----|------------|-----------|
| 20 | DKDM/CP NC | 15 | DKDMNC020E | 373,22 |
| 25 | DKDM/CP NC | 20 | DKDMNC025E | 395,31 |
| 32 | DKDM/CP NC | 25 | DKDMNC032E | 481,04 |
| 40 | DKDM/CP NC | 32 | DKDMNC040E | 634,15 |
| 50 | DKDM/CP NC | 40 | DKDMNC050E | 717,17 |
| 63 | DKDM/CP NC | 50 | DKDMNC063E | 995,32 |
| 75 | VKDM/CP NC | 65 | VKDMNC075E | 1.111,14 |
| 90 | VMDM/CP NC | 80 | VMDMNC090E | 1.806,91 |
| 110 | VMDM/CP NC | 100 | VMDMNC110E | 2.246,48 |



VM/CP NC

| Ref. FKM | € FKM | Ref. PTFE | € PTFE |
|------------|----------|------------|-----------|
| DKDMNC020F | 432,14 | DKDMNC020P | 457,94 |
| DKDMNC025F | 455,47 | DKDMNC025P | 478,80 |
| DKDMNC032F | 553,24 | DKDMNC032P | 582,08 |
| DKDMNC040F | 751,13 | DKDMNC040P | 782,68 |
| DKDMNC050F | 848,51 | DKDMNC050P | 882,90 |
| DKDMNC063F | 1.245,87 | DKDMNC063P | 1.209,41 |
| DKDMNC075F | 1.495,08 | DKDMNC075P | 1.451,27 |
| VMDMNC090F | 2.383,16 | VMDMNC090P | 2.075,50 |
| VMDMNC110F | 2.798,72 | VMDMNC110P | 2.500,05 |

Válvula neumática **NORMALMENTE CERRADA.**

M-M para soldar socket.



DK/CP NO

| d | Modelo | DN | Ref. EPDM | € EPDM |
|-----|------------|-----|------------|-----------|
| 20 | DKDM/CP NO | 15 | DKDMNO020E | 311,27 |
| 25 | DKDM/CP NO | 20 | DKDMNO025E | 333,39 |
| 32 | DKDM/CP NO | 25 | DKDMNO032E | 416,61 |
| 40 | DKDM/CP NO | 32 | DKDMNO040E | 441,49 |
| 50 | DKDM/CP NO | 40 | DKDMNO050E | 515,85 |
| 63 | DKDM/CP NO | 50 | DKDMNO063E | 660,93 |
| 75 | DKDM/CP NO | 65 | DKDMNO075E | 793,08 |
| 90 | VMDM/CP NO | 80 | VMDMNO090E | 1.253,08 |
| 110 | VMDM/CP NO | 100 | VMDMNO110E | 1.782,70 |



VM/CP NO

| Ref. FKM | € FKM | Ref. PTFE | € PTFE |
|------------|----------|------------|-----------|
| DKDMNO020F | 370,23 | DKDMNO020P | 396,01 |
| DKDMNO025F | 393,56 | DKDMNO025P | 416,92 |
| DKDMNO032F | 524,92 | DKDMNO032P | 557,13 |
| DKDMNO040F | 597,89 | DKDMNO040P | 638,91 |
| DKDMNO050F | 685,14 | DKDMNO050P | 731,45 |
| DKDMNO063F | 943,02 | DKDMNO063P | 935,01 |
| DKDMNO075F | 1.131,64 | DKDMNO075P | 1.122,01 |
| VMDMNO090F | 1.925,28 | VMDMNO090P | 1.566,30 |
| VMDMNO110F | 2.509,42 | VMDMNO110P | 1.886,58 |

Válvula neumática **NORMALMENTE ABIERTA.**

M-M para soldar socket.



DK/CP DE

| d | Modelo | DN | Ref. EPDM | € EPDM |
|-----|------------|-----|-----------|-----------|
| 20 | DKDM/CP DE | 15 | DKDMA020E | 249,39 |
| 25 | DKDM/CP DE | 20 | DKDMA025E | 271,46 |
| 32 | DKDM/CP DE | 25 | DKDMA032E | 365,58 |
| 40 | DKDM/CP DE | 32 | DKDMA040E | 401,34 |
| 50 | DKDM/CP DE | 40 | DKDMA050E | 445,17 |
| 63 | DKDM/CP DE | 50 | DKDMA063E | 570,37 |
| 75 | DKDM/CP DE | 65 | DKDMA075E | 684,43 |
| 90 | VMDM/CP DE | 80 | VMDMA090E | 1.538,13 |
| 110 | VMDM/CP DE | 100 | VMDMA110E | 2.056,40 |



VM/CP DE

| Ref. FKM | € FKM | Ref. PTFE | € PTFE |
|-----------|----------|-----------|-----------|
| DKDMA020F | 308,28 | DKDMA020P | 334,08 |
| DKDMA025F | 331,64 | DKDMA025P | 354,97 |
| DKDMA032F | 466,80 | DKDMA032P | 497,08 |
| DKDMA040F | 543,53 | DKDMA040P | 580,82 |
| DKDMA050F | 591,23 | DKDMA050P | 631,25 |
| DKDMA063F | 813,82 | DKDMA063P | 806,92 |
| DKDMA075F | 1.033,10 | DKDMA075P | 968,30 |
| VMDMA090F | 2.210,36 | VMDMA090P | 1.851,35 |
| VMDMA110F | 2.581,59 | VMDMA110P | 2.230,03 |

Válvula neumática **DOBLE EFECTO.**

M-M para soldar socket.



DK/CP NC

| d | Modelo | DN | Ref. EPDM | € EPDM | Ref. FKM | € FKM | Ref. PTFE | € PTFE |
|----|-------------|----|-------------|-----------|-------------|----------|-------------|-----------|
| 20 | DKUIM/CP NC | 15 | DKUIMNC020E | 390,40 | DKUIMNC020F | 450,60 | DKUIMNC020P | 476,41 |
| 25 | DKUIM/CP NC | 20 | DKUIMNC025E | 413,75 | DKUIMNC025F | 450,60 | DKUIMNC025P | 497,23 |
| 32 | DKUIM/CP NC | 25 | DKUIMNC032E | 504,11 | DKUIMNC032F | 576,34 | DKUIMNC032P | 605,26 |
| 40 | DKUIM/CP NC | 32 | DKUIMNC040E | 658,69 | DKUIMNC040F | 775,64 | DKUIMNC040P | 808,86 |
| 50 | DKUIM/CP NC | 40 | DKUIMNC050E | 743,76 | DKUIMNC050F | 875,04 | DKUIMNC050P | 909,42 |
| 63 | DKUIM/CP NC | 50 | DKUIMNC063E | 1.034,41 | DKUIMNC063F | 1.254,69 | DKUIMNC063P | 1.248,44 |

Válvula neumática **NORMALMENTE CERRADA.**

Con enlaces H-H para soldar socket.



DK/CP NO

| d | Modelo | DN | Ref. EPDM | € EPDM | Ref. FKM | € FKM | Ref. PTFE | € PTFE |
|----|-------------|----|-------------|-----------|-------------|----------|-------------|-----------|
| 20 | DKUIM/CP NO | 15 | DKUIMNO020E | 328,50 | DKUIMNO020F | 388,67 | DKUIMNO020P | 414,47 |
| 25 | DKUIM/CP NO | 20 | DKUIMNO025E | 351,85 | DKUIMNO025F | 388,67 | DKUIMNO025P | 435,31 |
| 32 | DKUIM/CP NO | 25 | DKUIMNO032E | 441,69 | DKUIMNO032F | 538,31 | DKUIMNO032P | 491,72 |
| 40 | DKUIM/CP NO | 32 | DKUIMNO040E | 473,13 | DKUIMNO040F | 629,57 | DKUIMNO040P | 670,51 |
| 50 | DKUIM/CP NO | 40 | DKUIMNO050E | 550,07 | DKUIMNO050F | 719,40 | DKUIMNO050P | 765,68 |
| 63 | DKUIM/CP NO | 50 | DKUIMNO063E | 713,33 | DKUIMNO063F | 993,38 | DKUIMNO063P | 987,34 |

Válvula neumática **NORMALMENTE ABIERTA.**

Con enlaces H-H para soldar socket.



DK/CP DE

| d | Modelo | DN | Ref. EPDM | € EPDM | Ref. FKM | € FKM | Ref. PTFE | € PTFE |
|----|-------------|----|-------------|-----------|-------------|----------|-------------|-----------|
| 20 | DKUIM/CP DE | 15 | DKUIMDA020E | 266,56 | DKUIMDA020F | 326,75 | DKUIMDA020P | 352,52 |
| 25 | DKUIM/CP DE | 20 | DKUIMDA025E | 289,92 | DKUIMDA025F | 326,75 | DKUIMDA025P | 373,41 |
| 32 | DKUIM/CP DE | 25 | DKUIMDA032E | 389,22 | DKUIMDA032F | 478,69 | DKUIMDA032P | 520,70 |
| 40 | DKUIM/CP DE | 32 | DKUIMDA040E | 430,13 | DKUIMDA040F | 572,32 | DKUIMDA040P | 609,55 |
| 50 | DKUIM/CP DE | 40 | DKUIMDA050E | 474,69 | DKUIMDA050F | 620,84 | DKUIMDA050P | 660,77 |
| 63 | DKUIM/CP DE | 50 | DKUIMDA063E | 615,58 | DKUIMDA063F | 857,29 | DKUIMDA063P | 852,07 |

Válvula neumática **DOBLE EFECTO.**

Con enlaces H-H para soldar socket.



Sistema PP-H Socket

Válvulas de membrana actuadas



DK/CP NC



| d | Modelo | DN | Ref. EPDM | € EPDM |
|-----|------------|-----|------------|-----------|
| 20 | DKOM/CP NC | 15 | DKOMNC020E | 429,20 |
| 25 | DKOM/CP NC | 20 | DKOMNC025E | 454,64 |
| 32 | DKOM/CP NC | 25 | DKOMNC032E | 553,11 |
| 40 | DKOM/CP NC | 32 | DKOMNC040E | 729,19 |
| 50 | DKOM/CP NC | 40 | DKOMNC050E | 824,75 |
| 63 | DKOM/CP NC | 50 | DKOMNC063E | 1.144,64 |
| 75 | DKOM/CP NC | 65 | DKOMNC075E | 1.373,61 |
| 90 | VMOM/CP NC | 80 | VMOMNC090E | 2.077,92 |
| 110 | VMOM/CP NC | 100 | VMOMNC110E | 2.583,45 |

VM/CP NC



| Ref. FKM | € FKM | Ref. PTFE | € PTFE |
|------------|----------|------------|-----------|
| DKOMNC020F | 488,12 | DKOMNC020P | 513,92 |
| DKOMNC025F | 514,77 | DKOMNC025P | 538,10 |
| DKOMNC032F | 625,34 | DKOMNC032P | 621,06 |
| DKOMNC040F | 846,23 | DKOMNC040P | 650,23 |
| DKOMNC050F | 956,08 | DKOMNC050P | 990,43 |
| DKOMNC063F | 1.395,22 | DKOMNC063P | 1.358,72 |
| DKOMNC075F | 1.674,24 | DKOMNC075P | 1.630,47 |
| VMOMNC090F | 2.654,19 | VMOMNC090P | 2.346,58 |
| VMOMNC110F | 3.134,78 | VMOMNC110P | 2.836,70 |

Válvula neumática **NORMALMENTE CERRADA.**
Con bridas DIN.

Disponibles con bridas ANSI 150 libras al mismo precio

DK/CP NO



| d | Modelo | DN | Ref. EPDM | € EPDM |
|-----|------------|-----|------------|-----------|
| 20 | DKOM/CP NO | 15 | DKOMNO020E | 367,25 |
| 25 | DKOM/CP NO | 20 | DKOMNO025E | 392,69 |
| 32 | DKOM/CP NO | 25 | DKOMNO032E | 498,60 |
| 40 | DKOM/CP NO | 32 | DKOMNO040E | 546,11 |
| 50 | DKOM/CP NO | 40 | DKOMNO050E | 634,17 |
| 63 | DKOM/CP NO | 50 | DKOMNO063E | 825,13 |
| 75 | DKOM/CP NO | 65 | DKOMNO075E | 990,14 |
| 90 | VMOM/CP NO | 80 | VMOMNO090E | 1.524,09 |
| 110 | VMOM/CP NO | 100 | VMOMNO110E | 2.029,15 |

VM/CP NO



| Ref. FKM | € FKM | Ref. PTFE | € PTFE |
|------------|----------|------------|-----------|
| DKOMNO020F | 426,21 | DKOMNO020P | 451,99 |
| DKOMNO025F | 452,87 | DKOMNO025P | 476,17 |
| DKOMNO032F | 606,88 | DKOMNO032P | 541,30 |
| DKOMNO040F | 702,54 | DKOMNO040P | 743,54 |
| DKOMNO050F | 803,45 | DKOMNO050P | 849,78 |
| DKOMNO063F | 1.107,28 | DKOMNO063P | 1.099,27 |
| DKOMNO075F | 1.328,73 | DKOMNO075P | 1.319,10 |
| VMOMNO090F | 2.196,25 | VMOMNO090P | 1.837,31 |
| VMOMNO110F | 2.593,93 | VMOMNO110P | 2.221,04 |

Válvula neumática **NORMALMENTE ABIERTA.**
Con bridas DIN.

Disponibles con bridas ANSI 150 libras al mismo precio

DK/CP DE



| d | Modelo | DN | Ref. EPDM | € EPDM |
|-----|------------|-----|------------|-----------|
| 20 | DKOM/CP DE | 15 | DKOMDA020E | 305,34 |
| 25 | DKOM/CP DE | 20 | DKOMDA025E | 330,76 |
| 32 | DKOM/CP DE | 25 | DKOMDA032E | 442,80 |
| 40 | DKOM/CP DE | 32 | DKOMDA040E | 496,49 |
| 50 | DKOM/CP DE | 40 | DKOMDA050E | 547,27 |
| 63 | DKOM/CP DE | 50 | DKOMDA063E | 712,07 |
| 75 | DKOM/CP DE | 65 | DKOMDA075E | 854,50 |
| 90 | VMOM/CP DE | 80 | VMOMDA090E | 1.809,17 |
| 110 | VMOM/CP DE | 100 | VMOMDA110E | 2.302,87 |

VM/CP DE



| Ref. FKM | € FKM | Ref. PTFE | € PTFE |
|------------|----------|------------|-----------|
| DKOMDA020F | 364,29 | DKOMDA020P | 390,06 |
| DKOMDA025F | 390,94 | DKOMDA025P | 414,25 |
| DKOMDA032F | 544,03 | DKOMDA032P | 492,08 |
| DKOMDA040F | 638,68 | DKOMDA040P | 675,94 |
| DKOMDA050F | 693,37 | DKOMDA050P | 733,35 |
| DKOMDA063F | 955,57 | DKOMDA063P | 948,63 |
| DKOMDA075F | 1.146,68 | DKOMDA075P | 1.138,38 |
| VMOMDA090F | 2.481,37 | VMOMDA090P | 2.122,42 |
| VMOMDA110F | 2.930,64 | VMOMDA110P | 2.565,71 |

Válvula neumática **DOBLE EFECTO.**
Con bridas DIN.

Disponibles con bridas ANSI 150 libras al mismo precio

CMDM/CP NC *M-M para fusión socket*
CMIM/CP NC *H-H para fusión socket*
CMUIM/CP NC *H-H enlaces fusión socket*
CMFM/CP NC *H-H roscar*



| d-Rh | Ref. EPDM | DN | EPDM | FKM | PTFE |
|---------|--------------------|----|--------|--------|--------|
| 20 | CMDMNC020E | 15 | 170,44 | 225,36 | 254,20 |
| 16 | CMIMNC016E | 12 | 163,20 | 190,68 | 205,12 |
| 20 | CMIMNC020E | 15 | 163,20 | 190,68 | 205,12 |
| 20-1/2" | CMUIMNC020E | 15 | 239,76 | 271,51 | 285,98 |
| 3/8" | CMFMNC038E | 12 | 163,20 | 190,68 | 205,12 |
| 1/2" | CMFMNC012E | 15 | 163,20 | 190,68 | 205,12 |

Válvula de membrana compacta neumática
NORMALMENTE CERRADA

Código en FKM termina en "F" en lugar de "E"
 Código en PTFE termina en "P" en lugar de "E"
 (A) = Juntas en FKM

CMDM/CP NO *M-M para fusión socket*
CMIM/CP NO *H-H para fusión socket*
CMUIM/CP NO *H-H enlaces fusión socket*
CMFM/CP NO *H-H roscar*



| d-Rh | Ref. EPDM | DN | EPDM | FKM | PTFE |
|---------|--------------------|----|--------|--------|--------|
| 20 | CMDMNO020E | 15 | 169,00 | 220,99 | 251,32 |
| 16 | CMIMNO016E | 12 | 161,76 | 187,77 | 202,22 |
| 20 | CMIMNO020E | 15 | 161,76 | 187,77 | 202,22 |
| 20-1/2" | CMUIMNO020E | 15 | 236,90 | 267,18 | 283,07 |
| 3/8" | CMFMNO038E | 12 | 161,76 | 187,77 | 202,22 |
| 1/2" | CMFMNO012E | 15 | 161,76 | 187,77 | 202,22 |

Válvula de membrana compacta neumática
NORMALMENTE ABIERTA

Código en FKM termina en "F" en lugar de "E"
 Código en PTFE termina en "P" en lugar de "E"
 (A) = Juntas en FKM

CMDM/CP DE *M-M para fusión socket*
CMIM/CP DE *H-H para fusión socket*
CMUIM/CP DE *H-H enlaces fusión socket*
CMFM/CP DE *H-H roscar*



| d-Rh | Ref. EPDM | DN | EPDM | FKM | PTFE |
|---------|--------------------|----|--------|--------|--------|
| 20 | CMDMDA020E | 15 | 169,00 | 220,99 | 251,32 |
| 16 | CMIMDA016E | 12 | 187,77 | 187,77 | 202,22 |
| 20 | CMIMDA020E | 15 | 161,76 | 187,77 | 202,22 |
| 20-1/2" | CMUIMDA020E | 15 | 236,90 | 267,18 | 283,07 |
| 3/8" | CMFMDA038E | 12 | 161,76 | 187,77 | 202,22 |
| 1/2" | CMFMDA012E | 15 | 161,76 | 187,77 | 202,22 |

Válvula de membrana compacta neumática
DOBLE EFECTO

Código en FKM termina en "F" en lugar de "E"
 Código en PTFE termina en "P" en lugar de "E"
 (A) = Juntas en FKM



DKBDM/CP NC

| d | Ref. EPDM | DN | PN | € EPDM |
|----|-------------|----|----|-----------|
| 20 | DKBDMNC020E | 15 | 6 | 329,62 |
| 25 | DKBDMNC025E | 20 | 6 | 349,11 |
| 32 | DKBDMNC032E | 25 | 6 | 454,64 |
| 40 | DKBDMNC040E | 32 | 6 | 566,09 |
| 50 | DKBDMNC050E | 40 | 6 | 591,92 |
| 63 | DKBDMNC063E | 50 | 6 | 821,40 |
| 75 | DKBDMNC075E | 65 | 6 | 985,66 |

Válvula de membrana neumática
Normalmente Cerrada.
M-M soldar socket.

Actuador a pistón



DKBUIM/CP NC

| d | Ref. EPDM | DN | PN | € EPDM |
|----|--------------|----|----|-----------|
| 20 | DKBUIMNC020E | 15 | 6 | 344,80 |
| 25 | DKBUIMNC025E | 20 | 6 | 365,44 |
| 32 | DKBUIMNC032E | 25 | 6 | 476,56 |
| 40 | DKBUIMNC040E | 32 | 6 | 587,98 |
| 50 | DKBUIMNC050E | 40 | 6 | 613,78 |
| 63 | DKBUIMNC063E | 50 | 6 | 853,66 |

Válvula de membrana neumática
Normalmente Cerrada.
Con enlaces H-H para soldar socket.

Actuador a pistón



DKBOM/CP NC

| d | Ref. EPDM | DN | PN | € EPDM |
|----|-------------|----|----|-----------|
| 20 | DKBOMNC020E | 15 | 6 | 379,04 |
| 25 | DKBOMNC025E | 20 | 6 | 401,52 |
| 32 | DKBOMNC032E | 25 | 6 | 532,72 |
| 40 | DKBOMNC040E | 32 | 6 | 668,99 |
| 50 | DKBOMNC050E | 40 | 6 | 699,45 |
| 63 | DKBOMNC063E | 50 | 6 | 970,67 |
| 75 | DKBOMNC075E | 65 | 6 | 1.261,90 |

Válvula de membrana neumática
Normalmente Cerrada.
Con bridas DIN.

Actuador a pistón



DKBOAM/CP NC

| d | Ref. EPDM | DN | PN | € EPDM |
|------|--------------|----|----|-----------|
| ½" | DKBOAMNC012E | 15 | 6 | 379,04 |
| ¾" | DKBOAMNC034E | 20 | 6 | 401,52 |
| 1" | DKBOAMNC100E | 25 | 6 | 532,72 |
| 1 ¼" | DKBOAMNC114E | 32 | 6 | 668,99 |
| 1 ½" | DKBOAMNC112E | 40 | 6 | 699,45 |
| 2" | DKBOAMNC200E | 50 | 6 | 964,75 |
| 2 ½" | DKBOAMNC212E | 65 | 6 | 1.197,91 |

Válvula de membrana neumática
Normalmente Cerrada.
Con bridas ANSI 150 lbs.

Actuador a pistón



Sistema PP-H Socket

Válvulas de control de presión



VSF

| d | Ref. EPDM | DN | PN | € | |
|----|------------------|----|----|----------|----------|
| | | | | EPDM | PTFE |
| 16 | VSFBM016E | 10 | 10 | 464,12 | 539,80 |
| 20 | VSFBM020E | 15 | 10 | 546,55 | 576,21 |
| 25 | VSFBM025E | 20 | 10 | 602,53 | 660,30 |
| 32 | VSFBM032E | 25 | 10 | 637,62 | 690,19 |
| 40 | VSFBM040E | 32 | 10 | 804,72 | 882,38 |
| 50 | VSFBM050E | 40 | 10 | 1.340,42 | 1.436,13 |
| 63 | VSFBM063E | 50 | 10 | 1.800,23 | 1.864,62 |

Válvula de sobrepresión-alivio.
M-M para soldadura a testa.

Código en PTFE termina en "P"
en lugar de "E"
Rango de calibración: 0,5 - 10 bars



VCP

| d | Ref. EPDM | DN | PN | € | |
|----|------------------|----|----|----------|----------|
| | | | | EPDM | PTFE |
| 16 | VCPBM016E | 10 | 10 | 423,74 | 459,57 |
| 20 | VCPBM020E | 15 | 10 | 423,74 | 459,57 |
| 25 | VCPBM025E | 20 | 10 | 566,55 | 606,65 |
| 32 | VCPBM032E | 25 | 10 | 608,58 | 657,63 |
| 40 | VCPBM040E | 32 | 10 | 775,95 | 816,02 |
| 50 | VCPBM050E | 40 | 10 | 1.197,46 | 1.241,44 |
| 63 | VCPBM063E | 50 | 10 | 1.566,66 | 1.602,56 |

Válvula retenedora de presión.
M-M para soldadura a testa.

Código en PTFE termina en "P"
en lugar de "E"
Rango de calibración: 0,5 - 10 bars



VPR

| d | Ref. | DN | PN | € | |
|----|------------------|----|----|----------|----------|
| | | | | EPDM | FKM |
| 16 | VPRBM016E | 10 | 10 | 1.183,47 | 1.226,92 |
| 20 | VPRBM020E | 15 | 10 | 1.183,47 | 1.226,92 |
| 25 | VPRBM025E | 20 | 10 | 1.510,39 | 1.576,52 |
| 32 | VPRBM032E | 25 | 10 | 1.510,39 | 1.576,52 |
| 40 | VPRBM040E | 32 | 10 | 1.818,39 | 1.900,38 |
| 50 | VPRBM050E | 40 | 10 | 1.818,39 | 1.900,38 |
| 63 | VPRBM063E | 50 | 10 | 2.571,34 | 2.651,79 |

Válvula reductora de presión.
M-M para soldadura a testa.

Código en FKM termina en "F"
en lugar de "E"
Rango de calibración: 0,5 - 9 bars



INDUSTRIA

Sistema PP-H Socket Conectores



MANGUITO

| d | Ref. EPDM | Para válvulas | € |
|-----|-----------|----------------------|--------|
| 16 | ENDIM016 | VKD-VKR-TKD-SR-RV-VR | 15,26 |
| 20 | ENDIM020 | VKD-VKR-TKD-SR-RV-VR | 15,26 |
| 25 | ENDIM025 | VKD-VKR-TKD-SR-RV-VR | 18,15 |
| 32 | ENDIM032 | VKD-VKR-TKD-SR-RV-VR | 20,07 |
| 40 | ENDIM040 | VKD-VKR-TKD-SR-RV-VR | 24,80 |
| 50 | ENDIM050 | VKD-VKR-TKD-SR-RV-VR | 28,52 |
| 63 | ENDIM063 | VKD-VKR-TKD-SR-RV-VR | 36,13 |
| 75 | ENDIM075 | VKD | 85,62 |
| 90 | ENDIM090 | VKD | 93,46 |
| 110 | ENDIM110 | VKD | 129,78 |

Conector final en PP-H.

H para soldar socket.

MANGUITO

| Rh | Ref. EPDM | Para válvulas | € |
|--------|-----------|----------------------|-------|
| 1/2" | ENDNM012 | VKD-VKR-TKD-SR-RV-VR | 15,26 |
| 3/4" | ENDNM034 | VKD-VKR-TKD-SR-RV-VR | 18,15 |
| 1" | ENDNM100 | VKD-VKR-TKD-SR-RV-VR | 20,07 |
| 1 1/4" | ENDNM114 | VKD-VKR-TKD-SR-RV-VR | 24,80 |
| 1 1/2" | ENDNM112 | VKD-VKR-TKD-SR-RV-VR | 28,52 |
| 2" | ENDNM200 | VKD-VKR-TKD-SR-RV-VR | 36,13 |

Conector final en PP-H.

H rosca NPT.

Q-BBM/L

| d | Ref. EPDM | Para válvulas | € |
|----|------------|---------------|-------|
| 20 | QBBML11020 | CM-DK | 5,10 |
| 25 | QBBML11025 | CM-DK | 6,15 |
| 32 | QBBML11032 | CM-DK | 7,55 |
| 40 | QBBML11040 | CM-DK | 9,80 |
| 50 | QBBML11050 | CM-DK | 10,35 |
| 63 | QBBML11063 | CM-DK | 14,89 |

Conector final en PP SDR11.

Para soldar a testa o electrofusión.

MANGUITO

| Rh | Ref. EPDM | Para válvulas | € |
|--------|-----------|----------------------|-------|
| 3/8" | ENDFM038 | VKD-VKR-TKD-SR-RV-VR | 15,26 |
| 1/2" | ENDFM012 | VKD-VKR-TKD-SR-RV-VR | 14,88 |
| 3/4" | ENDFM034 | VKD-VKR-TKD-SR-RV-VR | 17,70 |
| 1" | ENDFM100 | VKD-VKR-TKD-SR-RV-VR | 20,07 |
| 1 1/4" | ENDFM114 | VKD-VKR-TKD-SR-RV-VR | 24,18 |
| 1 1/2" | ENDFM112 | VKD-VKR-TKD-SR-RV-VR | 27,81 |
| 2" | ENDFM200 | VKD-VKR-TKD-SR-RV-VR | 35,23 |

Conector final en PP-H.

H rosca gas.

MANGUITO

| d | Ref. EPDM | Para válvulas | € |
|-----|-----------|----------------------|--------|
| 20 | ENDDM020 | VKD-VKR-TKD-SR-RV-VR | 15,26 |
| 25 | ENDDM025 | VKD-VKR-TKD-SR-RV-VR | 18,15 |
| 32 | ENDDM032 | VKD-VKR-TKD-SR-RV-VR | 20,07 |
| 40 | ENDDM040 | VKD-VKR-TKD-SR-RV-VR | 24,80 |
| 50 | ENDDM050 | VKD-VKR-TKD-SR-RV-VR | 28,52 |
| 63 | ENDDM063 | VKD-VKR-TKD-SR-RV-VR | 36,13 |
| 75 | ENDDM075 | VKD | 85,62 |
| 90 | ENDDM090 | VKD | 93,46 |
| 110 | ENDDM110 | VKD | 116,26 |

Conector final en PP-H.

M para soldar socket.

CVDM

| d | Ref. EPDM | Para válvulas | € |
|-----|-----------|----------------------|-------|
| 20 | CVDM11020 | VKD-VKR-TKD-SR-RV-VR | 7,21 |
| 25 | CVDM11025 | VKD-VKR-TKD-SR-RV-VR | 8,46 |
| 32 | CVDM11032 | VKD-VKR-TKD-SR-RV-VR | 10,40 |
| 40 | CVDM11040 | VKD-VKR-TKD-SR-RV-VR | 12,94 |
| 50 | CVDM11050 | VKD-VKR-TKD-SR-RV-VR | 16,80 |
| 63 | CVDM11063 | VKD-VKR-TKD-SR-RV-VR | 21,60 |
| 75 | CVDM11075 | VKD | 43,73 |
| 90 | CVDM11090 | VKD | 54,96 |
| 110 | CVDM11110 | VKD | 66,58 |

Conector final en PP-H SDR11.

Para soldar a testa o electrofusión.

Accesorios



0805

Sistema PP-H testa / butt welding

INDUSTRIA





Sistema PP-H Testa



**GBM/GKM**

| d | Ref. PN6 | € PN6 SDR 17,6 | Ref. PN10 | € PN10 SDR 11 |
|-----|----------|-------------------|-----------|------------------|
| 20 | | | GKM11020 | 1,23 |
| 25 | | | GKM11025 | 1,54 |
| 32 | | | GKM11032 | 2,31 |
| 40 | | | GKM11040 | 2,87 |
| 50 | GKM17050 | 3,18 | GKM11050 | 4,77 |
| 63 | GKM17063 | 7,28 | GKM11063 | 7,54 |
| 75 | GKM17075 | 8,56 | GKM11075 | 9,28 |
| 90 | GKM17090 | 11,03 | GKM11090 | 14,56 |
| 110 | GKM17110 | 17,23 | GBM11110 | 36,18 |
| 125 | GBM17125 | 44,79 | GBM11125 | 50,97 |
| 140 | GBM17140 | 65,04 | GBM11140 | 68,11 |
| 160 | GBM17160 | 69,75 | GBM11160 | 82,98 |
| 180 | GBM17180 | 88,68 | GBM11180 | 98,24 |
| 200 | GBM17200 | 109,82 | GBM11200 | 146,41 |
| 225 | GBM17225 | 135,38 | GBM11225 | 174,65 |
| 250 | GBM17250 | 228,61 | GBM11250 | 336,20 |
| 280 | GBM17280 | 297,09 | GBM11280 | 437,14 |
| 315 | GBM17315 | 410,44 | GBM11315 | 603,50 |
| 355 | GBM17355 | 931,41 | GBM11355 | 1.264,13 |
| 400 | GBM17400 | 1.296,99 | GBM11400 | 1.736,00 |
| 450 | GBM17450 | 1.671,30 | GBM11450 | 2.245,37 |
| 500 | GBM17500 | 2.108,94 | GBM11500 | 2.896,51 |

Curva 90°.

M-M para soldar a testa.

**HBM**

| d | Ref. PN6 | € PN6 SDR 17,6 | Ref. PN10 | € PN10 SDR 11 |
|-----|----------|-------------------|-----------|------------------|
| 20 | | | HBM11020 | 3,54 |
| 25 | | | HBM11025 | 3,70 |
| 32 | | | HBM11032 | 3,83 |
| 40 | | | HBM11040 | 4,96 |
| 50 | HBM17050 | 4,96 | HBM11050 | 6,23 |
| 63 | HBM17063 | 8,27 | HBM11063 | 8,95 |
| 75 | HBM17075 | 12,07 | HBM11075 | 12,36 |
| 90 | HBM17090 | 15,77 | HBM11090 | 17,88 |
| 110 | HBM17110 | 33,20 | HBM11110 | 34,04 |
| 125 | HBM17125 | 42,18 | HBM11125 | 47,96 |
| 140 | HBM17140 | 61,24 | HBM11140 | 64,13 |
| 160 | HBM17160 | 67,53 | HBM11160 | 78,13 |
| 180 | HBM17180 | 108,65 | HBM11180 | 120,85 |
| 200 | HBM17200 | 148,64 | HBM11200 | 165,17 |
| 225 | HBM17225 | 177,35 | HBM11225 | 196,88 |
| 250 | HBM17250 | 343,14 | HBM11250 | 381,32 |
| 280 | HBM17280 | 518,19 | HBM11280 | 575,77 |
| 315 | HBM17315 | 644,86 | HBM11315 | 720,39 |

Codo 45°.

M-M para soldar a testa.

**CBM**

| d | Ref. PN6 | € PN6 SDR 17,6 | Ref. PN10 | € PN10 SDR 11 |
|-----|----------|-------------------|-----------|------------------|
| 20 | | | CBM11020 | 4,88 |
| 25 | | | CBM11025 | 5,37 |
| 32 | | | CBM11032 | 6,79 |
| 40 | | | CBM11040 | 8,46 |
| 50 | | | CBM11050 | 11,01 |
| 63 | CBM17063 | 14,55 | CBM11063 | 14,52 |
| 75 | CBM17075 | 22,47 | CBM11075 | 22,47 |
| 90 | CBM17090 | 34,12 | CBM11090 | 34,12 |
| 110 | CBM17110 | 46,25 | CBM11110 | 46,25 |
| 125 | CBM17125 | 57,71 | CBM11125 | 49,97 |
| 140 | CBM17140 | 62,51 | CBM11140 | 62,51 |
| 160 | CBM17160 | 70,07 | CBM11160 | 70,07 |
| 180 | CBM17180 | 91,09 | CBM11180 | 91,09 |

Tapón.

M para soldar a testa.

| d | Ref. PN6 | € PN6 SDR 17,6 | Ref. PN10 | € PN10 SDR 11 |
|-----|----------|-------------------|-----------|------------------|
| 200 | CBM17200 | 113,45 | CBM11200 | 113,45 |
| 225 | CBM17225 | 135,43 | CBM11225 | 135,43 |
| 250 | CBM17250 | 172,70 | CBM11250 | 172,70 |
| 280 | CBM17280 | 244,69 | CBM11280 | 244,69 |
| 315 | CBM17315 | 326,78 | CBM11315 | 326,78 |
| 355 | CBM17355 | 422,43 | CBM11355 | 359,60 |
| 400 | CBM17400 | 522,95 | CBM11400 | 492,98 |
| 450 | CBM17450 | 720,05 | CBM11450 | 745,59 |
| 500 | CBM17500 | 862,08 | CBM11500 | 948,07 |
| 560 | CBM17560 | 1.099,14 | | |
| 630 | CBM17630 | 1.667,54 | | |
| 710 | CBM17710 | 2.516,90 | | |
| 800 | CBM17800 | 3.945,96 | | |



QBM

| d | Ref. PN6 | € PN6 SDR 17,6 | Ref. PN10 | € PN10 SDR 11 |
|-------|-----------|-------------------|-----------|------------------|
| 20 | | | QBM11020 | 3,41 |
| 25 | | | QBM11025 | 3,41 |
| 32 | | | QBM11032 | 4,04 |
| 40 | QBM17040 | 4,65 | QBM11040 | 4,83 |
| 50 | QBM17050 | 5,44 | QBM11050 | 5,91 |
| 63 | QBM17063 | 6,63 | QBM11063 | 7,36 |
| 75 | QBM17075 | 7,82 | QBM11075 | 8,74 |
| 90 | QBM17090 | 11,48 | QBM11090 | 12,55 |
| 110 | QBM17110 | 14,61 | QBM11110 | 16,14 |
| 125 | QBM17125 | 17,90 | QBM11125 | 19,44 |
| 140 | QBM17140 | 20,84 | QBM11140 | 22,71 |
| 160 | QBM17160 | 25,75 | QBM11160 | 28,65 |
| 180 | QBM17180 | 37,64 | QBM11180 | 44,44 |
| 200 | QBM17200 | 47,04 | QBM11200 | 48,91 |
| 225 | QBM17225 | 52,72 | QBM11225 | 54,51 |
| 250 | QBM17250 | 75,32 | QBM11250 | 82,74 |
| 280 | QBM17280 | 82,74 | QBM11280 | 90,40 |
| 315 | QBM17315 | 101,02 | QBM11315 | 106,51 |
| 355 | QBM17355 | 247,99 | QBM11355 | 270,84 |
| 400 | QBM17400 | 501,16 | QBM11400 | 533,51 |
| 450 | QBM17450 | 582,14 | QBM11450 | 615,97 |
| 500 | QBM17500 | 717,67 | QBM11500 | 780,03 |
| 560 | QBM17560 | 859,05 | QBM11560 | 1.011,96 |
| 630 | QBM17630 | 994,88 | QBM11630 | 1.205,44 |
| 710 | QBM17710 | 1.461,12 | | |
| 800 | QBM17800 | 2.118,95 | | |
| 900 | QBM17900 | 3.892,56 | | |
| 1.000 | QBM171000 | 6.381,64 | | |

Manguito portabridas.
M para soldar a testa.



TBM

| d | Ref. PN6 | € PN6 SDR 17,6 | Ref. PN10 | € PN10 SDR 11 |
|-----|----------|-------------------|-----------|------------------|
| 20 | | | TBM11020 | 3,01 |
| 25 | | | TBM11025 | 3,01 |
| 32 | | | TBM11032 | 3,78 |
| 40 | | | TBM11040 | 6,03 |
| 50 | TBM17050 | 9,56 | TBM11050 | 8,16 |
| 63 | TBM17063 | 9,80 | TBM11063 | 12,63 |
| 75 | TBM17075 | 20,04 | TBM11075 | 25,43 |
| 90 | TBM17090 | 28,60 | TBM11090 | 38,01 |
| 110 | TBM17110 | 47,46 | TBM11110 | 55,81 |
| 125 | TBM17125 | 65,79 | TBM11125 | 76,86 |
| 140 | TBM17140 | 77,64 | TBM11140 | 97,38 |
| 160 | TBM17160 | 145,99 | TBM11160 | 163,80 |
| 180 | TBM17180 | 179,30 | TBM11180 | 209,93 |
| 200 | TBM17200 | 244,87 | TBM11200 | 300,79 |
| 225 | TBM17225 | 287,47 | TBM11225 | 357,80 |
| 250 | TBM17250 | 382,43 | TBM11250 | 455,21 |
| 280 | TBM17280 | 431,25 | TBM11280 | 615,44 |
| 315 | TBM17315 | 573,58 | TBM11315 | 874,25 |
| 355 | TBM17355 | 1.235,12 | TBM11355 | 1.463,21 |
| 400 | TBM17400 | 1.688,17 | TBM11400 | 2.184,78 |
| 450 | TBM17450 | 2.314,12 | TBM11450 | 2.845,25 |
| 500 | TBM17500 | 2.978,02 | TBM11500 | 3.636,37 |

Te 90°.

M-M-M para soldar a testa.



TRBM

| d x dr | Ref. PN6 | € PN6 SDR 17,6 | Ref. PN10 | € PN10 SDR 11 | d x dr | Ref. PN6 | € PN6 SDR 17,6 | Ref. PN10 | € PN10 SDR 11 |
|------------|--------------|-------------------|--------------|------------------|------------|--------------|-------------------|--------------|------------------|
| 63 x 50* | TRBM17063050 | 23,59 | TRBM11063050 | 25,48 | 180 x 63 | TRBM17180063 | 238,86 | TRBM11180063 | 279,26 |
| 75 x 32* | | | TRBM11075032 | 39,90 | 180 x 75 | TRBM17180075 | 238,86 | TRBM11180075 | 279,26 |
| 75 x 50* | TRBM17075050 | 35,71 | TRBM11075050 | 39,90 | 180 x 90* | TRBM17180090 | 288,32 | TRBM11180090 | 319,45 |
| 75 x 63* | TRBM17075063 | 36,32 | TRBM11075063 | 40,67 | 180 x 110* | TRBM17180110 | 246,14 | TRBM11180110 | 319,45 |
| 90 x 32 | | | TRBM11090032 | 50,44 | 180 x 125 | TRBM17180125 | 246,14 | TRBM11180125 | 288,25 |
| 90 x 50 | | | TRBM11090050 | 51,84 | 180 x 160* | TRBM17180160 | 288,32 | TRBM11180160 | 319,45 |
| 90 x 63* | TRBM17090063 | 50,79 | TRBM11090063 | 56,84 | 200 x 63* | TRBM17200063 | 325,93 | TRBM11200063 | 400,45 |
| 90 x 75* | TRBM17090075 | 51,23 | TRBM11090075 | 57,29 | 200 x 90* | TRBM17200090 | 329,60 | TRBM11200090 | 404,71 |
| 110 x 32 | | | TRBM11110032 | 74,45 | 200 x 110* | TRBM17200110 | 333,22 | TRBM11200110 | 408,88 |
| 110 x 50 | | | TRBM11110050 | 75,98 | 200 x 125* | TRBM17200125 | 336,59 | TRBM11200125 | 413,40 |
| 110 x 63* | TRBM17110063 | 75,32 | TRBM11110063 | 84,27 | 200 x 160* | TRBM17200160 | 340,85 | TRBM11200160 | 417,89 |
| 110 x 75* | TRBM17110075 | 75,32 | TRBM11110075 | 84,27 | 225 x 75* | TRBM17225075 | 486,55 | TRBM11225075 | 540,06 |
| 110 x 90* | TRBM17110090 | 77,15 | TRBM11110090 | 85,44 | 225 x 90* | TRBM17225090 | 486,55 | TRBM11225090 | 540,06 |
| 125 x 63 | | | TRBM11125063 | 106,33 | 225 x 110* | TRBM17225110 | 488,19 | TRBM11225110 | 542,25 |
| 125 x 90 | | | TRBM11125090 | 117,23 | 225 x 125 | TRBM17225125 | 391,40 | TRBM11225125 | 486,24 |
| 125 x 110* | TRBM17125110 | 104,64 | TRBM11125110 | 117,23 | 225 x 160* | TRBM17225160 | 489,52 | TRBM11225160 | 544,16 |
| 140 x 63 | TRBM17140063 | 103,56 | TRBM11140063 | 133,40 | 225 x 180* | TRBM17225180 | 490,38 | TRBM11225180 | 546,03 |
| 140 x 75 | TRBM17140075 | 104,03 | TRBM11140075 | 133,40 | 250 x 110 | TRBM17250110 | 513,50 | TRBM11250110 | 641,74 |
| 140 x 90 | TRBM17140090 | 105,72 | TRBM11140090 | 135,51 | 250 x 160 | TRBM17250160 | 523,93 | TRBM11250160 | 654,98 |
| 140 x 110 | TRBM17140110 | 107,88 | TRBM11140110 | 135,51 | 315 x 110 | | | TRBM11315110 | 1.449,71 |
| 160 x 63* | TRBM17160063 | 207,35 | TRBM11160063 | 230,48 | 315 x 225 | | | TRBM11315225 | 1.515,63 |
| 160 x 75* | TRBM17160075 | 213,71 | TRBM11160075 | 232,41 | 315 x 250 | | | TRBM11315250 | 1.515,63 |
| 160 x 90* | TRBM17160090 | 213,71 | TRBM11160090 | 232,41 | | | | | |
| 160 x 110* | TRBM17160110 | 215,69 | TRBM11160110 | 232,41 | | | | | |
| 160 x 125 | TRBM17160125 | 201,17 | TRBM11160125 | 224,93 | | | | | |

Te a 90° reducida.

M-M para soldar a testa.

* Espigots LARGOS



QBM FK

| d Vál | d Tubo | Ref. PN6 | € PN6 SDR 17,6 | Ref. PN10 | € PN10 SDR 11 |
|----------|-----------|------------|-------------------|------------|------------------|
| 50 | 50 | QPM17050 | 6,84 | QPM11050 | 7,43 |
| 63 | 63 | QPM17063 | 8,34 | QPM11063 | 9,19 |
| 75 | 75 | QPM17075 | 9,88 | QPM11075 | 11,06 |
| 90 | 90 | QPM17090 | 14,42 | QPM11090 | 15,77 |
| 110 | 110 | QPM17110 | 18,32 | QPM11110 | 20,94 |
| 140 | 125 | QPM17125 | 22,42 | QPM11125 | 24,40 |
| 160 | 140 | QPM17140 | 26,07 | QPM11140 | 28,50 |
| 160 | 160 | QPM17160 | 32,30 | QPM11FK160 | 55,34 |
| 160 | 180 | QPM17180 | 50,02 | QPM11180 | 59,00 |
| 225 | 200 | QBM17FK200 | 90,35 | QPM11FK200 | 94,27 |
| 225 | 225 | QPM17225 | 65,92 | QPM11FK225 | 105,00 |
| 280 | 250 | QPM17250 | 94,26 | QPM11FK250 | 159,39 |
| 280 | 280 | QBM17FK280 | 153,66 | QPM11FK280 | 174,11 |
| 315 | 315 | QBM17FK315 | 194,20 | QPM11FK315 | 205,15 |
| 355 | 350 | QBM17FK355 | 460,80 | QPM11FK355 | 505,20 |
| 400 | 400 | QBM17FK400 | 871,38 | QPM11FK400 | 940,69 |

Manguito portabridas
 para válvulas de mariposa FE/FK.
 M para soldar a testa.



QBAM

| d | Ref. PN6 | € PN6 SDR 17,6 | Ref. PN10 | € PN10 SDR 11 |
|-----|-----------|-------------------|-----------|------------------|
| ¾" | | | QBAM11034 | 4,51 |
| 1" | | | QBAM11100 | 5,34 |
| 1¼" | QBAM17114 | 6,13 | QBAM11114 | 6,37 |
| 1½" | QBAM17112 | 7,18 | QBAM11112 | 7,79 |
| 3" | QBAM17300 | 15,18 | QBAM11300 | 16,51 |

Manguito portabridas largo

ANSI 150 lbs.

M para soldar a testa.

ODB



| d | Ref. | DN | PN | € |
|-----|-------------|------|----|----------|
| 20 | ODB020 | 15 | 16 | 8,85 |
| 25 | ODB025 | 20 | 16 | 9,72 |
| 32 | ODB032 | 25 | 16 | 12,51 |
| 40 | ODB040 | 32 | 16 | 15,18 |
| 50 | ODB050 | 40 | 16 | 17,75 |
| 63 | ODB063 | 50 | 16 | 22,08 |
| 75 | ODB075 | 65 | 16 | 24,40 |
| 90 | ODB090 | 80 | 16 | 29,06 |
| 110 | ODB110 | 100 | 16 | 35,07 |
| 125 | ODB125 | 100 | 16 | 35,07 |
| 140 | ODB140 | 125 | 16 | 52,43 |
| 140 | ODB140DN125 | *125 | 16 | 50,37 |
| 160 | ODB160 | 150 | 16 | 53,41 |
| 180 | ODB180 | 150 | 16 | 61,24 |
| 200 | ODB200 | 200 | 10 | 80,21 |
| 225 | ODB225 | 200 | 10 | 80,21 |
| 225 | ODB225DN200 | *200 | 10 | 103,49 |
| 250 | ODB250 | 250 | 10 | 100,41 |
| 280 | ODB280 | 250 | 10 | 102,29 |
| 280 | ODB280DN250 | *250 | 10 | 107,16 |
| 315 | ODB315 | 300 | 10 | 156,19 |
| 315 | ODB315DN300 | *300 | 10 | 156,94 |
| 355 | ODB355 | 350 | 10 | 292,39 |
| 400 | ODB400 | 400 | 10 | 421,93 |
| 450 | ODB450 | 450 | 10 | 754,43 |
| 500 | ODB500 | 500 | 10 | 754,43 |
| 560 | ODB560 | 600 | 10 | 1.023,11 |
| 630 | ODB630 | 600 | 10 | 1.037,63 |

Brida loca PP con alma de acero
DIN 2501 DIN 16962/16963.

* Para portabridas PVC-U

A partir de Ø 75 no utilizar
con portabridas socket
(sólo testa)

OAB



| d | Ref. | DN | € |
|-----|--------|-----|--------|
| ½" | OAB012 | 15 | 10,99 |
| ¾" | OAB034 | 20 | 13,68 |
| 1" | OAB100 | 25 | 16,14 |
| 1¼" | OAB114 | 32 | 18,59 |
| 1½" | OAB112 | 40 | 23,19 |
| 2" | OAB200 | 50 | 28,81 |
| 2½" | OAB212 | 65 | 35,60 |
| 3" | OAB300 | 80 | 41,73 |
| 4" | OAB400 | 100 | 54,44 |
| 6" | OAB600 | 150 | 102,85 |
| 8" | OAB800 | 200 | 148,79 |
| 10" | OAB810 | 250 | 191,63 |
| 12" | OAB812 | 300 | 295,58 |
| 14" | OAB814 | 350 | 557,70 |
| 16" | OAB816 | 400 | 680,04 |

Brida loca PP con alma de acero
ANSI 150 lbs.

A partir de Ø 75 no utilizar
con portabridas socket
(sólo testa)

ODBC



| d | Ref. | DN | PN | € |
|---------|---------|-----|----|----------|
| 20 | ODBC020 | 15 | 16 | 67,53 |
| 25 | ODBC025 | 20 | 16 | 68,59 |
| 32 | ODBC032 | 25 | 16 | 70,33 |
| 40 | ODBC040 | 32 | 16 | 75,32 |
| 50 | ODBC050 | 40 | 16 | 85,30 |
| 63 | ODBC063 | 50 | 16 | 92,89 |
| 75 | ODBC075 | 65 | 16 | 108,81 |
| 90 | ODBC090 | 80 | 16 | 119,75 |
| 110/125 | ODBC110 | 100 | 16 | 163,58 |
| 140 | ODBC140 | 125 | 16 | 200,88 |
| 160/180 | ODBC160 | 150 | 16 | 253,51 |
| 200/225 | ODBC200 | 200 | 10 | 281,56 |
| 250/280 | ODBC250 | 250 | 10 | 367,93 |
| 315 | ODBC315 | 300 | 10 | 537,13 |
| 355 | ODBC355 | 350 | 10 | 1.050,68 |
| 400 | ODBC400 | 400 | 10 | 1.200,24 |

Brida ciega PP con alma de acero DIN 2501

OABC



| d | Ref. | DN | € |
|-----|---------|-----|--------|
| ½" | OABC012 | 15 | 78,52 |
| ¾" | OABC034 | 20 | 79,63 |
| 1" | OABC100 | 25 | 81,59 |
| 1¼" | OABC114 | 32 | 87,42 |
| 1½" | OABC112 | 40 | 99,25 |
| 2" | OABC200 | 50 | 108,02 |
| 2½" | OABC212 | 65 | 123,41 |
| 3" | OABC300 | 80 | 139,15 |
| 4" | OABC400 | 100 | 190,13 |
| 6" | OABC600 | 150 | 294,77 |
| 8" | OABC800 | 200 | 327,32 |
| 10" | OABC810 | 250 | 427,45 |
| 12" | OABC812 | 300 | 624,68 |

Brida ciega PP con alma de acero ANSI 150 lbs.

RBM



| d x dr | Ref. PN6 | € PN6 SDR 17,6 | Ref. PN10 | € PN10 SDR 11 |
|-----------|-------------|-------------------|-------------|------------------|
| 25 x 20 | | | RBM11025020 | 5,02 |
| 32 x 20 | | | RBM11032020 | 5,81 |
| 32 x 25 | | | RBM11032025 | 5,81 |
| 40 x 20 | | | RBM11040020 | 6,65 |
| 40 x 25 | | | RBM11040025 | 6,65 |
| 40 x 32 | | | RBM11040032 | 6,65 |
| 50 x 25 | | | RBM11050025 | 6,99 |
| 50 x 32 | RBM17050032 | 6,65 | RBM11050032 | 6,99 |
| 50 x 40 | RBM17050040 | 6,65 | RBM11050040 | 6,99 |
| 63 x 32 | RBM17063032 | 8,02 | RBM11063032 | 8,48 |
| 63 x 40 | RBM17063040 | 8,02 | RBM11063040 | 8,48 |
| 63 x 50 | RBM17063050 | 8,02 | RBM11063050 | 8,48 |
| 75 x 32 | RBM17075032 | 10,35 | RBM11075032 | 10,86 |
| 75 x 40 | RBM17075040 | 10,35 | RBM11075040 | 10,86 |
| 75 x 50 | RBM17075050 | 10,35 | RBM11075050 | 10,86 |
| 75 x 63 | RBM17075063 | 10,35 | RBM11075063 | 10,86 |
| 90 x 50 | RBM17090050 | 11,52 | RBM11090050 | 12,04 |
| 90 x 63 | RBM17090063 | 11,52 | RBM11090063 | 12,04 |
| 90 x 75 | RBM17090075 | 11,52 | RBM11090075 | 12,04 |
| 110 x 50 | RBM17110050 | 14,69 | RBM11110050 | 15,37 |
| 110 x 63 | RBM17110063 | 14,69 | RBM11110063 | 15,37 |
| 110 x 75 | RBM17110075 | 14,69 | RBM11110075 | 15,37 |
| 110 x 90 | RBM17110090 | 14,69 | RBM11110090 | 15,37 |
| 125 x 63 | RBM17125063 | 18,83 | RBM11125063 | 19,79 |
| 125 x 75 | RBM17125075 | 18,83 | RBM11125075 | 19,76 |
| 125 x 90 | RBM17125090 | 18,83 | RBM11125090 | 19,79 |
| 125 x 110 | RBM17125110 | 18,83 | RBM11125110 | 19,76 |
| 140 x 75 | RBM17140075 | 22,85 | RBM11140075 | 23,99 |
| 140 x 90 | RBM17140090 | 22,85 | RBM11140090 | 23,93 |
| 140 x 110 | RBM17140110 | 22,85 | RBM11140110 | 23,93 |
| 140 x 125 | RBM17140125 | 22,85 | RBM11140125 | 23,93 |
| 160 x 90 | RBM17160090 | 26,68 | RBM11160090 | 28,08 |
| 160 x 110 | RBM17160110 | 26,68 | RBM11160110 | 28,08 |
| 160 x 125 | RBM17160125 | 26,68 | RBM11160125 | 28,08 |
| 160 x 140 | RBM17160140 | 26,68 | RBM11160140 | 28,08 |
| 180 x 90 | RBM17180090 | 41,89 | RBM11180090 | 44,05 |
| 180 x 110 | RBM17180110 | 39,46 | | |
| 180 x 125 | RBM17180125 | 39,4594 | RBM11180125 | 38,21 |
| 180 x 140 | RBM17180140 | 34,55 | RBM11180140 | 36,29 |
| 180 x 160 | RBM17180160 | 34,55 | RBM11180160 | 34,63 |
| 200 x 140 | RBM17200140 | 94,71 | RBM11200140 | 99,37 |
| 200 x 160 | RBM17200160 | 83,56 | RBM11200160 | 87,68 |
| 200 x 180 | RBM17200180 | 74,74 | RBM11200180 | 78,52 |

Reducción concéntrica.

M-M para soldar a testa.

| d x dr | Ref. PN6 | € PN6 SDR 17,6 | Ref. PN10 | € PN10 SDR 11 |
|-----------|-------------|-------------------|-------------|------------------|
| 225 x 140 | RBM17225140 | 112,80 | RBM11225140 | 118,45 |
| 225 x 160 | RBM17225160 | 96,79 | RBM11225160 | 101,63 |
| 225 x 180 | RBM17225180 | 92,41 | RBM11225180 | 96,77 |
| 225 x 200 | RBM17225200 | 81,38 | RBM11225200 | 85,25 |
| 250 x 160 | RBM17250160 | 129,31 | RBM11250160 | 136,02 |
| 250 x 180 | RBM17250180 | 119,84 | RBM11250180 | 125,56 |
| 250 x 200 | RBM17250200 | 110,31 | RBM11250200 | 115,80 |
| 250 x 225 | RBM17250225 | 104,35 | RBM11250225 | 109,72 |
| 280 x 200 | RBM17280200 | 143,93 | RBM11280200 | 151,19 |
| 280 x 225 | RBM17280225 | 134,22 | RBM11280225 | 140,96 |
| 280 x 250 | RBM17280250 | 130,68 | RBM11280250 | 135,69 |
| 315 x 200 | RBM17315200 | 183,73 | RBM11315200 | 192,93 |
| 315 x 225 | RBM17315225 | 162,52 | RBM11315225 | 170,69 |
| 315 x 250 | RBM17315250 | 148,10 | RBM11315250 | 155,45 |
| 315 x 280 | RBM17315280 | 138,71 | RBM11315280 | 145,68 |
| 355 x 200 | RBM17355200 | 346,66 | RBM11355200 | 363,96 |
| 355 x 225 | RBM17355225 | 333,27 | RBM11355225 | 349,91 |
| 355 x 250 | RBM17355250 | 319,72 | RBM11355250 | 335,65 |
| 355 x 280 | RBM17355280 | 296,61 | RBM11355280 | 311,45 |
| 355 x 315 | RBM17355315 | 287,64 | RBM11355315 | 302,01 |
| 400 x 225 | RBM17400225 | 1.460,04 | RBM11400225 | 1.555,38 |
| 400 x 250 | RBM17400250 | 1.268,32 | RBM11400250 | 1.426,65 |
| 400 x 280 | RBM17400280 | 1.124,86 | RBM11400280 | 1.125,15 |
| 400 x 315 | RBM17400315 | 871,43 | RBM11400315 | 871,43 |
| 400 x 355 | RBM17400355 | 589,48 | RBM11400355 | 595,79 |
| 450 x 280 | RBM17450280 | 1.585,70 | RBM11450280 | 1.585,70 |
| 450 x 315 | RBM17450315 | 1.413,11 | RBM11450315 | 1.413,11 |
| 450 x 355 | RBM17450355 | 1.070,17 | RBM11450355 | 1.070,17 |
| 450 x 400 | RBM17450400 | 790,54 | RBM11450400 | 790,54 |
| 500 x 280 | RBM17500280 | 2.504,72 | RBM11500280 | 2.576,35 |
| 500 x 315 | RBM17500315 | 1.867,12 | RBM11500315 | 1.919,08 |
| 500 x 355 | RBM17500355 | 1.648,19 | RBM11500355 | 1.767,40 |
| 500 x 400 | RBM17500400 | 1.420,45 | RBM11500400 | 1.550,49 |
| 500 x 450 | RBM17500450 | 1.290,32 | RBM11500450 | 1.398,82 |
| 560 x 355 | RBM17560355 | 2.731,53 | RBM11560355 | 2.879,27 |
| 560 x 400 | RBM17560400 | 2.287,85 | RBM11560400 | 2.645,75 |
| 560 x 450 | RBM17560450 | 1.507,16 | RBM11560450 | 1.572,28 |
| 560 x 500 | RBM17560500 | 1.192,66 | RBM11560500 | 1.279,41 |
| 630 x 355 | RBM17630355 | 3.675,75 | | |
| 630 x 400 | RBM17630400 | 3.144,44 | | |
| 630 x 450 | RBM17630450 | 2.624,05 | | |
| 630 x 500 | RBM17630500 | 2.515,55 | | |
| 630 x 560 | RBM17630560 | 1.615,65 | | |
| 710 x 500 | RBM17710500 | 1.941,79 | | |
| 710 x 560 | RBM17710560 | 1.624,12 | | |
| 710 x 630 | RBM17710630 | 1.342,28 | | |
| 800 x 560 | RBM17800560 | 2.408,14 | | |
| 800 x 630 | RBM17800630 | 2.031,08 | | |
| 800 x 710 | RBM17800710 | 1.709,67 | | |

DBMM



| d x Rh | Ref. | € PN10 SDR 11 |
|----------|--------------|------------------|
| 20 x ½" | DBMM11020012 | 10,01 |
| 25 x ¾" | DBMM11025034 | 12,92 |
| 32 x 1" | DBMM11032100 | 15,23 |
| 40 x 1¼" | DBMM11040114 | 17,83 |
| 50 x 1½" | DBMM11050112 | 22,34 |
| 63 x 2" | DBMM11063200 | 26,44 |

Terminal rosca hembra largo.

M para soldar a testa o electrofusión - H rosca.

KBFM



| d x Rm | Ref. | € PN10 SDR 11 |
|----------|--------------|------------------|
| 20 x ½" | KBFM11020012 | 10,06 |
| 25 x ¾" | KBFM11025034 | 12,07 |
| 32 x 1" | KBFM11032100 | 15,23 |
| 40 x 1¼" | KBFM11040114 | 18,32 |
| 50 x 1½" | KBFM11050112 | 30,06 |
| 63 x 2" | KBFM11063200 | 37,96 |

Terminal rosca macho corto.

M para soldar a testa - M rosca.

BBM/L



| d | Ref. EPDM | € EPDM | Ref. FKM | € FKM |
|----|------------|-----------|------------|----------|
| 20 | BBML11020E | 19,28 | BBML11020F | 21,62 |
| 25 | BBML11025E | 24,03 | BBML11025F | 27,09 |
| 32 | BBML11032E | 24,75 | BBML11032F | 27,41 |
| 40 | BBML11040E | 35,10 | BBML11040F | 41,49 |
| 50 | BBML11050E | 43,87 | BBML11050F | 50,81 |
| 63 | BBML11063E | 57,55 | BBML11063F | 65,57 |

Unión 3 piezas largo.

SDR 11 (PN10).

M-M para soldar a testa y electrofusión.

BBM/C



| d | Ref. EPDM | € EPDM | Ref. FKM | € FKM |
|----|------------|-----------|------------|----------|
| 20 | BBMC11020E | 19,28 | BBMC11020F | 21,62 |
| 25 | BBMC11025E | 24,03 | BBMC11025F | 27,09 |
| 32 | BBMC11032E | 24,75 | BBMC11032F | 27,41 |
| 40 | BBMC11040E | 35,10 | BBMC11040F | 41,49 |
| 50 | BBMC11050E | 43,87 | BBMC11050F | 50,81 |
| 63 | BBMC11063E | 57,55 | BBMC11063F | 65,57 |

Unión 3 piezas corto.

SDR 11 (PN10).

M-M para soldar a testa.

Q-BBM/L



| d | Ref. | € SDR 11 |
|-----|------------|-------------|
| 20 | QBBML11020 | 5,10 |
| 25 | QBBML11025 | 6,15 |
| 32 | QBBML11032 | 7,55 |
| 40 | QBBML11040 | 9,80 |
| 50 | QBBML11050 | 10,35 |
| 63 | QBBML11063 | 14,89 |
| 75 | QBBML11075 | 21,16 |
| 90 | QBBML11090 | 23,61 |
| 110 | QBBML11110 | 30,71 |

Manguito porta tuerca unión 3 piezas largo.

M para soldar a testa y electrofusión.

Q-BBM/C



| d | Ref. | € SDR 11 |
|-----|------------|-------------|
| 20 | QBBMC11020 | 5,10 |
| 25 | QBBMC11025 | 6,47 |
| 32 | QBBMC11032 | 6,47 |
| 40 | QBBMC11040 | 10,88 |
| 50 | QBBMC11050 | 10,88 |
| 63 | QBBMC11063 | 11,94 |
| 75 | QBBMC11075 | 16,33 |
| 90 | QBBMC11090 | 24,82 |
| 110 | QBBMC11110 | 28,97 |

Manguito porta tuerca unión 3 piezas corto.

M para soldar a testa.

F-BBM/L



| d | Ref. | € SDR 11 |
|-----|------------|-------------|
| 20 | FBBML11020 | 8,90 |
| 25 | FBBML11025 | 11,11 |
| 32 | FBBML11032 | 11,11 |
| 40 | FBBML11040 | 16,53 |
| 50 | FBBML11050 | 16,53 |
| 63 | FBBML11063 | 19,60 |
| 75 | FBBML11075 | 27,88 |
| 90 | FBBML11090 | 32,06 |
| 110 | FBBML11110 | 40,82 |

Manguito para tuerca unión 3 piezas largo.
SDR 11 (PN10).

M para soldar a testa y electrofusión.

F-BBM/C



| d | Ref. | € SDR 11 |
|-----|------------|-------------|
| 20 | FBBMC11020 | 7,71 |
| 25 | FBBMC11025 | 9,66 |
| 32 | FBBMC11032 | 9,66 |
| 40 | FBBMC11040 | 14,37 |
| 50 | FBBMC11050 | 14,37 |
| 63 | FBBMC11063 | 17,04 |
| 75 | FBBMC11075 | 23,22 |
| 90 | FBBMC11090 | 30,32 |
| 110 | FBBMC11110 | 41,24 |

Manguito para tuerca unión 3 piezas corto.
SDR 11 (PN10).

M para soldar a testa.

N-BBM



| d | Ref. | Rh | € SDR 11 |
|----|---------|-----|-------------|
| 20 | EFGM100 | 1" | 8,27 |
| 25 | EFGM114 | 1¼" | 8,56 |
| 32 | EFGM112 | 1½" | 9,93 |
| 40 | EFGM200 | 2" | 12,68 |
| 50 | EFGM214 | 2¼" | 19,65 |
| 63 | EFGM234 | 2¾" | 31,66 |

Tuerca para unión 3 piezas BBM
largo y corto.

H roscar.

O-BBM



| d | Ref. EPDM | € EPDM | Ref. FKM | € FKM |
|----|-----------|-----------|----------|----------|
| 20 | OR4081E | 5,73 | OR4081F | 12,01 |
| 25 | OR4112E | 2,06 | OR4112F | 2,26 |
| 32 | OR4131E | 2,94 | OR4131F | 6,39 |
| 40 | OR6162E | 3,12 | OR6162F | 9,42 |
| 50 | OR6187E | 3,31 | OR6187F | 10,74 |
| 63 | OR6237E | 3,62 | OR6237F | 12,01 |

Junta tórica para unión 3 piezas BBM
largo y corto.

Tubo y accesorios
Válvulas manuales
Válvulas actuadas
Válvulas de control de presión



0807

Sistema
PVDF

INDUSTRIA



Más información





Sistema PVDF





INDUSTRIA

Sistema PVDF

Tubo y accesorios



Consultar precios



| d | Ref. | Epesor mm. | €/m |
|-----|------------|------------|----------|
| 16 | PIPEF21016 | 1,9 | 43,34 |
| 20 | PIPEF21020 | 1,9 | 64,97 |
| 25 | PIPEF21025 | 1,9 | 83,67 |
| 32 | PIPEF21032 | 2,4 | 136,37 |
| 40 | PIPEF21040 | 2,4 | 170,83 |
| 50 | PIPEF21050 | 3,0 | 264,14 |
| 63 | PIPEF21063 | 3,0 | 338,20 |
| 75 | PIPEF21075 | 3,6 | 481,25 |
| 90 | PIPEF21090 | 4,3 | 688,92 |
| 110 | PIPEF21110 | 5,3 | 1.030,21 |

Tubo PVDF ISO 10931-2.
PN16. Barras de 5 m.

Disponible en Pn10
de 63 a 110 mm.
Precios consultar

GIF



| d | Ref. | Pack | € |
|-----|--------|------|--------|
| 16 | GIF016 | 10 | 11,46 |
| 20 | GIF020 | 10 | 13,13 |
| 25 | GIF025 | 10 | 16,25 |
| 32 | GIF032 | 10 | 33,84 |
| 40 | GIF040 | 5 | 54,28 |
| 50 | GIF050 | 5 | 80,60 |
| 63 | GIF063 | 2 | 136,61 |
| 75 | GIF075 | 2 | 234,41 |
| 90 | GIF090 | 2 | 347,37 |
| 110 | GIF110 | 2 | 638,55 |

Codo 90°.

H-H para fusión socket.

HIF



| d | Ref. | Pack | € |
|-----|--------|------|--------|
| 20 | HIF020 | 10 | 15,50 |
| 25 | HIF025 | 10 | 22,59 |
| 32 | HIF032 | 10 | 26,47 |
| 40 | HIF040 | 5 | 44,44 |
| 50 | HIF050 | 5 | 49,32 |
| 63 | HIF063 | 5 | 79,60 |
| 75 | HIF075 | 2 | 197,66 |
| 90 | HIF090 | 2 | 300,43 |
| 110 | HIF110 | 2 | 535,19 |

Codo 45°.

H-H para fusión socket.

TIF



| d | Ref. | Pack | € |
|-----|--------|------|--------|
| 16 | TIF016 | 10 | 21,82 |
| 20 | TIF020 | 10 | 23,00 |
| 25 | TIF025 | 10 | 28,25 |
| 32 | TIF032 | 10 | 41,92 |
| 40 | TIF040 | 5 | 65,20 |
| 50 | TIF050 | 5 | 99,50 |
| 63 | TIF063 | 5 | 156,33 |
| 75 | TIF075 | 2 | 295,80 |
| 90 | TIF090 | 2 | 446,14 |
| 110 | TIF110 | 2 | 818,75 |

Te a 90°.

H-H-H para fusión socket.

CIF



| d | Ref. | Pack | € |
|-----|--------|------|--------|
| 16* | CIF016 | 10 | 14,45 |
| 20 | CIF020 | 10 | 16,25 |
| 25 | CIF025 | 10 | 17,80 |
| 32 | CIF032 | 10 | 20,48 |
| 40 | CIF040 | 5 | 39,04 |
| 50 | CIF050 | 5 | 45,97 |
| 63 | CIF063 | 5 | 74,19 |
| 75 | CIF075 | 2 | 77,87 |
| 90 | CIF090 | 2 | 96,44 |
| 110 | CIF110 | 2 | 141,63 |

Tapón.

H para fusión socket.

QRNF



| d | Ref. | Pack | € |
|-----|---------|------|--------|
| 20 | QRNF020 | 10 | 14,88 |
| 25 | QRNF025 | 10 | 18,73 |
| 32 | QRNF032 | 10 | 19,09 |
| 40 | QRNF040 | 5 | 31,72 |
| 50 | QRNF050 | 5 | 37,52 |
| 63 | QRNF063 | 2 | 57,22 |
| 75 | QRNF075 | 2 | 110,00 |
| 90 | QRNF090 | 2 | 150,15 |
| 110 | QRNF110 | 2 | 195,19 |

Manguito portabridas.

H para fusión socket.

Consultar precios

QRAF



| d | Ref. | Pack | € |
|-----|----------------|------|---------------|
| ¾" | QRAF034 | 10 | 22,51 |
| 1" | QRAF100 | 10 | 19,09 |
| 1¼" | QRAF114 | 5 | 38,04 |
| 1½" | QRAF112 | 5 | 45,01 |
| 3" | QRAF300 | - | 234,20 |

Manguito portabridas **ANSI 150 lbs.**

H para fusión socket.

MIF



| d | Ref. | Pack | € |
|-----|---------------|------|---------------|
| 20 | MIF020 | 10 | 9,46 |
| 25 | MIF025 | 10 | 11,23 |
| 32 | MIF032 | 10 | 15,22 |
| 40 | MIF040 | 5 | 23,00 |
| 50 | MIF050 | 5 | 67,83 |
| 63 | MIF063 | 2 | 97,54 |
| 75 | MIF075 | 2 | 102,64 |
| 90 | MIF090 | 2 | 158,67 |
| 110 | MIF110 | 2 | 293,48 |

Manguito.

H-H para fusión socket.

RIF



| dm x dh | Ref. | Pack | € |
|----------|------------------|------|---------------|
| 20 x 16 | RIF020016 | 10 | 13,65 |
| 25 x 20 | RIF025020 | 10 | 16,05 |
| 32 x 25 | RIF032025 | 10 | 21,53 |
| 40 x 25 | RIF040025 | 10 | 26,30 |
| 40 x 32 | RIF040032 | 10 | 29,75 |
| 50 x 32 | RIF050032 | 5 | 32,01 |
| 50 x 40 | RIF050040 | 5 | 37,49 |
| 63 x 32 | RIF063032 | 5 | 44,99 |
| 63 x 50 | RIF063050 | 5 | 47,74 |
| 75 x 63 | RIF075063 | 2 | 99,50 |
| 90 x 63 | RIF090063 | 2 | 108,44 |
| 90 x 75 | RIF090075 | 2 | 108,44 |
| 110 x 90 | RIF110090 | 2 | 163,65 |

Reducción cónica.

M-H para fusión socket.

ODC



| d | Ref. | Pack | € |
|-----|---------------|------|--------------|
| 20 | ODC020 | 15 | 7,31 |
| 25 | ODC025 | 20 | 8,70 |
| 32 | ODC032 | 25 | 10,09 |
| 40 | ODC040 | 32 | 12,34 |
| 50 | ODC050 | 40 | 15,94 |
| 63 | ODC063 | 50 | 17,75 |
| 75 | ODC075 | 65 | 26,42 |
| 90 | ODC090 | 80 | 29,20 |
| 110 | ODC110 | 100 | 40,10 |

Brida loca.

UNI 2223 PN10. En C-PVC para manguito portabridas.

Descuento de la familia C-PVC.

ODB



| d | Ref. | Pack | € |
|-----|-----------------|------|--------------|
| 20 | ODB020 | 15 | 8,85 |
| 25 | ODB025 | 20 | 9,72 |
| 32 | ODB032 | 25 | 12,51 |
| 40 | ODB040 | 32 | 15,18 |
| 50 | ODB050 | 40 | 17,75 |
| 63 | ODB063 | 50 | 22,08 |
| 75 | ODB075 | 65 | 24,40 |
| 90 | ODB090 | 80 | 29,06 |
| 125 | **ODB125 | 100 | 35,07 |

Brida loca.

En PP con alma de acero.

PN10. Para manguito portabridas.

Versión ANSI 150 lbs (ver OAB página 320).

Descuento de la familia PP-H.

Más diámetros en página 320

**Para uso con portabridas QRNF110.

BIGF



| d | Ref. | Pack | € FKM |
|----|-----------------|------|---------------|
| 20 | BIGF020F | 10 | 41,75 |
| 25 | BIGF025F | 10 | 56,29 |
| 32 | BIGF032F | 10 | 68,37 |
| 40 | BIGF040F | 2 | 97,54 |
| 50 | BIGF050F | 2 | 135,84 |
| 63 | BIGF063F | 2 | 205,21 |

Unión 3 piezas.

Junta FKM.

H-H para fusión socket.



INDUSTRIA

Sistema PVDF Válvulas de bola



Consultar precios



BIFXF

| d x Rh | Ref. | € FKM |
|-------------|---------------------|---------------|
| 20 x 1/2" | BIFXF020012F | 189,16 |
| 25 x 3/4" | BIFXF025034F | 280,01 |
| 32 x 1" | BIFXF032100F | 345,15 |
| 40 x 1 1/4" | BIFXF040114F | 470,56 |
| 50 x 1 1/2" | BIFXF050112F | 502,88 |
| 63 x 2" | BIFXF063200F | 585,09 |

Unión 3 piezas mixto PVDF / Inox A316L.

Junta FKM.

H-H para fusión socket - roscar inox



BIRXF

| d x Rm | Ref. | € FKM |
|-------------|---------------------|---------------|
| 20 x 1/2" | BIRXF020012F | 212,93 |
| 25 x 3/4" | BIRXF025034F | 312,17 |
| 32 x 1" | BIRXF032100F | 395,96 |
| 40 x 1 1/4" | BIRXF040114F | 577,35 |
| 50 x 1 1/2" | BIRXF050112F | 588,52 |
| 63 x 2" | BIRXF063200F | 679,70 |

Unión 3 piezas mixto PVDF / Inox A316L.

Junta FKM.

H-M para fusión socket - roscar inox



VKDIF

| d | Ref. | DN | PN | € FKM |
|----|------------------|----|----|-----------------|
| 16 | VKDIF016F | 10 | 16 | 217,26 |
| 20 | VKDIF020F | 15 | 16 | 225,70 |
| 25 | VKDIF025F | 20 | 16 | 281,22 |
| 32 | VKDIF032F | 25 | 16 | 360,89 |
| 40 | VKDIF040F | 32 | 16 | 467,31 |
| 50 | VKDIF050F | 40 | 16 | 673,34 |
| 63 | VKDIF063F | 50 | 16 | 1.001,01 |

Válvula de bola DUAL BLOCK®.

Asiento PTFE (teflón). Bidireccional.

H-H para fusión socket.



VKDDF

| d | Ref. | DN | PN | € FKM |
|----|------------------|----|----|-----------------|
| 20 | VKDDF020F | 15 | 16 | 265,77 |
| 25 | VKDDF025F | 20 | 16 | 332,31 |
| 32 | VKDDF032F | 25 | 16 | 420,81 |
| 40 | VKDDF040F | 32 | 16 | 531,48 |
| 50 | VKDDF050F | 40 | 16 | 775,18 |
| 63 | VKDDF063F | 50 | 16 | 1.151,57 |

Válvula de bola DUAL BLOCK®.

Asiento PTFE (teflón). Bidireccional.

M-M para fusión socket.



VKDIF

| d | Ref. | DN | PN | € FKM |
|-----|------------------|-----|----|-----------------|
| 75 | VKDIF075F | 65 | 16 | 2.599,03 |
| 90 | VKDIF090F | 80 | 16 | 3.273,49 |
| 110 | VKDIF110F | 100 | 16 | 4.771,06 |

Válvula de bola DUAL BLOCK®.

Asiento PTFE (teflón). Bidireccional.

H-H para fusión socket.



VKDDF

| d | Ref. | DN | PN | € FKM |
|-----|------------------|-----|----|-----------------|
| 75 | VKDDF075F | 65 | 16 | 2.858,87 |
| 90 | VKDDF090F | 80 | 16 | 3.600,78 |
| 110 | VKDDF110F | 100 | 16 | 5.248,26 |

Válvula de bola DUAL BLOCK®.

Asiento PTFE (teflón). Bidireccional.

M-M para fusión socket.

Consultar precios



VKDBF

| d | Ref. | DN | PN | € FKM |
|----|-----------|----|----|----------|
| 20 | VKDBF020F | 15 | 16 | 234,44 |
| 25 | VKDBF025F | 20 | 16 | 332,31 |
| 32 | VKDBF032F | 25 | 16 | 420,81 |
| 40 | VKDBF040F | 32 | 16 | 531,48 |
| 50 | VKDBF050F | 40 | 16 | 775,18 |
| 63 | VKDBF063F | 50 | 16 | 1.151,57 |

Válvula de bola DUAL BLOCK®.
 Asiento PTFE (teflón). Bidireccional.
 M-M para fusión a tope.



VKDOF

| d | Ref. | DN | PN | € FKM |
|----|-----------|----|----|----------|
| 20 | VKDOF020F | 15 | 16 | 497,34 |
| 25 | VKDOF025F | 20 | 16 | 602,43 |
| 32 | VKDOF032F | 25 | 16 | 777,99 |
| 40 | VKDOF040F | 32 | 16 | 954,55 |
| 50 | VKDOF050F | 40 | 16 | 1.374,87 |
| 63 | VKDOF063F | 50 | 16 | 1.856,73 |

Válvula de bola DUAL BLOCK®.
 Asiento PTFE (teflón). Bidireccional.
 Con brida loca.

Versión con bridas ANSI 150 lbs
 al mismo precio



VKDBF

| d | Ref. | DN | PN | € FKM |
|-----|-----------|-----|----|----------|
| 75 | VKDBF075F | 65 | 16 | 2.858,92 |
| 90 | VKDBF090F | 80 | 16 | 3.600,78 |
| 110 | VKDBF110F | 100 | 16 | 5.248,21 |

Válvula de bola DUAL BLOCK®.
 Asiento PTFE (teflón). Bidireccional.
 M-M para fusión a tope.



VKDOF

| d | Ref. | DN | PN | € FKM |
|-----|-----------|-----|----|----------|
| 75 | VKDOF075F | 65 | 16 | 3.378,76 |
| 90 | VKDOF090F | 80 | 16 | 4.255,50 |
| 110 | VKDOF110F | 100 | 16 | 6.202,43 |

Válvula de bola DUAL BLOCK®.
 Asiento PTFE (teflón). Bidireccional.
 Con brida loca DIN y ANSI.



SETFLOI

| d DIN | d ANSI | Ref. | € DIN 2501 | € ANSI |
|-------|--------|------------|---------------|-----------|
| 20 | ½" | SETFLOF020 | 167,43 | 167,43 |
| 25 | ¾" | SETFLOF025 | 210,61 | 210,61 |
| 32 | 1" | SETFLOF032 | 258,27 | 258,27 |
| 40 | 1¼" | SETFLOF040 | 350,15 | 350,15 |
| 50 | 1½" | SETFLOF050 | 426,16 | 426,16 |

Set embreadado.
 Compuesto por 1 brida, 1 anillo fijación y 1 tuerca.
 Para Válvulas VKD / VKR / SR.

| d DIN | d ANSI | Ref. | € DIN 2501 | € ANSI |
|-------|--------|------------|---------------|-----------|
| 63 | 2" | SETFLOF063 | 557,38 | 557,38 |
| 75 | 2½" | SETFLOF075 | 857,06 | 857,06 |
| 90 | 3" | SETFLOF090 | 1.284,34 | 1.284,34 |
| 110 | 4" | SETFLOF110 | 1.655,14 | 1.655,14 |

d. 75-90-110, es el mismo artículo para DIN y ANSI

Consultar precios



VKRIF

| d | Ref. | DN | PN | € FKM |
|----|-----------|----|----|----------|
| 16 | VKRIF016F | 10 | 16 | 446,40 |
| 20 | VKRIF020F | 15 | 16 | 454,88 |
| 25 | VKRIF025F | 20 | 16 | 518,22 |
| 32 | VKRIF032F | 25 | 16 | 627,66 |
| 40 | VKRIF040F | 32 | 16 | 765,55 |
| 50 | VKRIF050F | 40 | 16 | 1.272,75 |
| 63 | VKRIF063F | 50 | 16 | 2.142,86 |

Válvula de bola **REGULACIÓN** DUAL BLOCK®.

Asiento PTFE (teflón). Bidireccional
 H-H para fusión socket.



VKRDF

| d | Ref. | DN | PN | € FKM |
|----|-----------|----|----|----------|
| 20 | VKRDF020F | 15 | 16 | 217,00 |
| 25 | VKRDF025F | 20 | 16 | 218,24 |
| 32 | VKRDF032F | 25 | 16 | 219,48 |
| 40 | VKRDF040F | 32 | 16 | 220,72 |
| 50 | VKRDF050F | 40 | 16 | 221,96 |
| 63 | VKRDF063F | 50 | 16 | 223,20 |

Válvula de bola **REGULACIÓN** DUAL BLOCK®.

Asiento PTFE (teflón). Bidireccional
 M-M para fusión socket.



VKROF

| d | Ref. | DN | PN | € FKM |
|----|-----------|----|----|----------|
| 20 | VKROF020F | 15 | 16 | 726,49 |
| 25 | VKROF025F | 20 | 16 | 839,40 |
| 32 | VKROF032F | 25 | 16 | 1.044,76 |
| 40 | VKROF040F | 32 | 16 | 1.252,79 |
| 50 | VKROF050F | 40 | 16 | 1.974,30 |
| 63 | VKROF063F | 50 | 16 | 2.998,62 |

Válvula de bola **REGULACIÓN** DUAL BLOCK®.

Asiento PTFE (teflón). Bidireccional
 Con brida DIN 2501.



VKROAF

| d | Ref. | DN | PN | € FKM |
|-----|------------|----|----|----------|
| ½" | VKROAF012F | 15 | 16 | 726,49 |
| ¾" | VKROAF034F | 20 | 16 | 839,40 |
| 1" | VKROAF100F | 25 | 16 | 1.044,76 |
| 1¼" | VKROAF114F | 32 | 16 | 1.252,79 |
| 1½" | VKROAF112F | 40 | 16 | 1.974,30 |
| 2" | VKROAF200F | 50 | 16 | 2.998,62 |

Válvula de bola **REGULACIÓN** DUAL BLOCK®.

Asiento PTFE (teflón). Bidireccional
 Con bridas ANSI 150 lbs.



INDUSTRIA

Sistema PVDF

Válvulas de mariposa



Consultar precios



FKOF/FM

| d | Ref. | DN | € FKM |
|-------|------------|-----|-----------|
| 50 | FKOFFM050F | 40 | 744,27 |
| 63 | FKOFFM063F | 50 | 788,05 |
| 75 | FKOFFM075F | 65 | 875,60 |
| 90 | FKOFFM090F | 80 | 939,44 |
| 110 | FKOFFM110F | 100 | 981,69 |
| 125 | FKOFFM140F | 125 | 1.303,71 |
| 140 | FKOFFM140F | 125 | 1.303,71 |
| 160 | FKOFFM160F | 150 | 1.394,47 |
| 200 | FKOFFM225F | 200 | 1.809,10 |
| 225 | FKOFFM225F | 200 | 1.809,10 |
| 250** | FKOFFM280F | 250 | 6.714,38 |
| 280** | FKOFFM280F | 250 | 6.714,38 |
| 315** | FKOFFM315F | 300 | 7.322,00 |
| 355** | FKOFFM355F | 355 | 15.120,40 |
| 400** | FKOFFM400F | 400 | 18.533,43 |

Válvula de mariposa industrial.
A EJE LIBRE.

Para actuar. Cuerpo en PPGR,
eje inoxidable y disco en PVDF

** ANSI 150 lbs bajo pedido
al mismo precio.



FKOF/RM

| d | Ref. | DN | € FKM |
|-------|------------|-----|-----------|
| 75 | FKOFRM075F | 65 | 1.755,04 |
| 90 | FKOFRM090F | 80 | 1.795,58 |
| 110 | FKOFRM110F | 100 | 1.861,08 |
| 125 | FKOFRM140F | 125 | 2.215,98 |
| 140 | FKOFRM140F | 125 | 2.215,98 |
| 160 | FKOFRM160F | 150 | 2.256,49 |
| 200 | FKOFRM225F | 200 | 2.873,65 |
| 225 | FKOFRM225F | 200 | 2.873,65 |
| 250** | FKOFRM280F | 250 | 7.266,04 |
| 280** | FKOFRM280F | 250 | 7.266,04 |
| 315** | FKOFRM315F | 300 | 7.873,66 |
| 355** | FKOFRM350F | 350 | 283,96 |
| 400** | FKOFRM400F | 400 | 19.856,29 |

Válvula de mariposa industrial.
CON VOLANTE.

Cuerpo en PPGR,
eje inoxidable y disco en PVDF

** ANSI 150 lbs bajo pedido
al mismo precio.



FKOF/LM

| d | Ref. | DN | € FKM |
|-----|------------|-----|----------|
| 50 | FKOFLM050F | 40 | 832,80 |
| 63 | FKOFLM063F | 50 | 881,81 |
| 75 | FKOFLM075F | 65 | 979,68 |
| 90 | FKOFLM090F | 80 | 1.020,26 |
| 110 | FKOFLM110F | 100 | 1.083,90 |
| 125 | FKOFLM140F | 125 | 1.440,68 |
| 140 | FKOFLM140F | 125 | 1.440,68 |
| 160 | FKOFLM160F | 150 | 1.481,22 |
| 200 | FKOFLM225F | 200 | 1.920,85 |
| 225 | FKOFLM225F | 200 | 1.920,85 |

Válvula de mariposa industrial.

CON MANETA.

Cuerpo en PPGR,
eje inoxidable y disco en PVDF

** ANSI 150 lbs bajo pedido
al mismo precio.



FKOF/LM

| d | Ref. | DN | € FKM |
|-----|-------------|-----|----------|
| 75 | FKOLFLM075F | 65 | 1.218,88 |
| 90 | FKOLFLM090F | 80 | 1.332,69 |
| 110 | FKOLFLM110F | 100 | 1.423,24 |
| 125 | FKOLFLM140F | 125 | 1.893,83 |
| 140 | FKOLFLM140F | 125 | 1.893,83 |
| 160 | FKOLFLM160F | 150 | 1.971,10 |
| 200 | FKOLFLM225F | 200 | 2.428,08 |
| 225 | FKOLFLM225F | 200 | 2.428,08 |

Válvula de mariposa industrial. CON MANETA. LUG ISO-DIN.

Cuerpo en PPGR,
eje inoxidable y disco en PVDF

Consultar precios



FKOF/RM

| d | Ref. | DN | € FKM |
|-----|-------------|-----|----------|
| 75 | FKOLFRM075F | 65 | 1.994,23 |
| 90 | FKOLFRM090F | 80 | 2.107,91 |
| 110 | FKOLFRM110F | 100 | 2.200,50 |
| 125 | FKOLFRM140F | 125 | 2.669,18 |
| 140 | FKOLFRM140F | 125 | 2.669,18 |
| 160 | FKOLFRM160F | 150 | 2.746,30 |
| 200 | FKOLFRM225F | 200 | 3.380,78 |
| 225 | FKOLFRM225F | 200 | 3.380,78 |

Válvula de mariposa industrial. **CON VOLANTE. LUG ISO-DIN.**
 Cuerpo en PPGR, eje inoxidable y disco en PVDF



FKOF/LM

| d | Ref. | DN | € FKM |
|-----|--------------|-----|----------|
| 2½" | FKOALFLM212F | 65 | 1.338,47 |
| 3" | FKOALFLM300F | 80 | 1.457,98 |
| 4" | FKOALFLM400F | 100 | 1.560,30 |
| 5" | FKOALFLM500F | 125 | 2.075,11 |
| 6" | FKOALFLM600F | 150 | 2.167,76 |
| 8" | FKOALFLM800F | 200 | 2.680,64 |

Válvula de mariposa industrial. **CON MANETA. LUG ANSI.**
 Cuerpo en PPGR,
 eje inoxidable y disco en PVDF



FKOF/RM

| d | Ref. | DN | € FKM |
|-----|--------------|-----|-----------|
| 2½" | FKOALFRM212F | 65 | 2.113,78 |
| 3" | FKOALFRM300F | 80 | 2.233,31 |
| 4" | FKOALFRM400F | 100 | 2.337,44 |
| 5" | FKOALFRM500F | 125 | 2.850,43 |
| 6" | FKOALFRM600F | 150 | 2.943,00 |
| 8" | FKOALFRM800F | 200 | 3.633,42 |
| 10" | FKOALFRM810F | 250 | 9.697,55 |
| 12" | FKOALFRM812F | 300 | 10.360,99 |

Válvula de mariposa industrial. **CON VOLANTE. LUG ANSI.**
 Cuerpo en PPGR, eje inoxidable y disco en PVDF



INDUSTRIA

Sistema PVDF Válvulas de membrana



Consultar precios



DKDF

| d | Ref. | DN | PN | € EPDM | € FKM | € PTFE |
|----|----------|----|----|-----------|----------|-----------|
| 20 | DKDF020E | 15 | 10 | 259,46 | 354,94 | 396,37 |
| 25 | DKDF025E | 20 | 10 | 269,32 | 369,65 | 408,68 |
| 32 | DKDF032E | 25 | 10 | 310,80 | 408,68 | 445,37 |
| 40 | DKDF040E | 32 | 10 | 506,58 | 668,11 | 714,67 |
| 50 | DKDF050E | 40 | 10 | 582,47 | 746,47 | 793,05 |
| 63 | DKDF063E | 50 | 10 | 736,64 | 1.008,32 | 1.000,93 |
| 75 | DKDF075E | 65 | 10 | 883,95 | 1.209,99 | 1.201,11 |

Válvula de membrana
DIALOCK®.

M-M para soldar socket.

Código en FKM termina en "F"
en lugar de "E"
Código en PTFE termina en "P"
en lugar de "E"



VMDF

| d | Ref. | DN | € EPDM | € FKM | € PTFE |
|-----|----------|-----|-----------|----------|-----------|
| 90 | VMDF090E | 80 | 2.630,86 | 3.409,12 | 2.995,70 |
| 110 | VMDF110E | 100 | 3.345,49 | 4.645,15 | 3.795,91 |

Válvula de membrana.
M-M para fusión socket.

Código en FKM termina en "F"
en lugar de "E"
Código en PTFE termina en "P"
en lugar de "E"



VMOF

| d | Ref. | DN | € EPDM | € FKM | € PTFE |
|-----|----------|-----|-----------|----------|-----------|
| 90 | VMOF090E | 80 | 3.370,50 | 4.148,74 | 3.735,33 |
| 110 | VMOF110E | 100 | 4.222,18 | 5.521,83 | 4.672,60 |

Válvula de membrana.
Con bridas DIN. Bajo pedido
con bridas ANSI 150 lbs,
la mismo precio.

Código en FKM termina en "F"
en lugar de "E"
Código en PTFE termina en "P"
en lugar de "E"



DKUIF

| d | Ref. FKM | DN | PN | € EPDM | € FKM | € PTFE |
|----|-----------|----|----|-----------|----------|-----------|
| 20 | DKUIF020E | 15 | 10 | 350,10 | 445,37 | 487,09 |
| 25 | DKUIF025E | 20 | 10 | 369,65 | 469,94 | 509,06 |
| 32 | DKUIF032E | 25 | 10 | 440,56 | 538,43 | 575,08 |
| 40 | DKUIF040E | 32 | 10 | 702,36 | 863,86 | 910,40 |
| 50 | DKUIF050E | 40 | 10 | 814,99 | 976,59 | 1.023,08 |
| 63 | DKUIF063E | 50 | 10 | 1.054,82 | 1.326,38 | 1.319,20 |

Válvula de membrana
DIALOCK®.

Con enlaces H-H para soldar socket.

Código en FKM termina en "F"
en lugar de "E"
Código en PTFE termina en "P"
en lugar de "E"



DKOF

| d | Ref. | DN | PN | € EPDM | € FKM | € PTFE |
|----|----------|----|----|-----------|----------|-----------|
| 20 | DKOF020E | 15 | 10 | 469,20 | 564,57 | 606,10 |
| 25 | DKOF025E | 20 | 10 | 488,12 | 588,39 | 627,48 |
| 32 | DKOF032E | 25 | 10 | 539,87 | 637,76 | 674,42 |
| 40 | DKOF040E | 32 | 10 | 848,05 | 1.009,55 | 1.056,09 |
| 50 | DKOF050E | 40 | 10 | 937,85 | 1.101,82 | 1.148,33 |
| 63 | DKOF063E | 50 | 10 | 1.221,92 | 1.493,63 | 1.486,17 |
| 75 | DKOF075E | 65 | 10 | 1.588,47 | 1.941,74 | 1.932,00 |

Válvula de membrana
DIALOCK®.

Con bridas DIN

Código en FKM termina en "F"
en lugar de "E"
Código en PTFE termina en "P"
en lugar de "E"



DKOAF

| d | Ref. | DN | PN | € EPDM | € FKM | € PTFE |
|------|-----------|----|----|-----------|----------|-----------|
| ½" | DKOAF012E | 15 | 10 | 469,20 | 564,57 | 606,10 |
| ¾" | DKOAF034E | 20 | 10 | 488,12 | 588,39 | 627,48 |
| 1" | DKOAF100E | 25 | 10 | 539,87 | 637,76 | 674,42 |
| 1¼" | DKOAF114E | 32 | 10 | 848,05 | 1.009,55 | 1.056,09 |
| 1½" | DKOAF112E | 40 | 10 | 937,85 | 1.101,82 | 1.148,33 |
| 2" | DKOAF200E | 50 | 10 | 1.221,92 | 1.493,63 | 1.486,17 |
| 2 ½" | DKOAF212E | 65 | 10 | 1.588,47 | 1.941,74 | 1.932,00 |

Válvula de membrana
DIALOCK®.

Con bridas ANSI 150 lbs.

Código en FKM termina en "F"
en lugar de "E"
Código en PTFE termina en "P"
en lugar de "E"

CMDF

M-M fusión
socket.

CMIF

H-H fusión
socket.

CMUIF

H-H enlaces
socket.

CMFF

H-H roscar.



| d-Rh | Ref. EPDM | DN | € EPDM | € FKM | € PTFE |
|------|-----------|----|-----------|----------|-----------|
| 20 | CMDF020E | 15 | 237,50 | 255,08 | 266,70 |
| 16 | CMIF016E | 12 | 171,27 | 183,47 | 203,06 |
| 20 | CMIF020E | 15 | 190,99 | 225,26 | 246,87 |
| 20 | CMUIF020E | 15 | 249,81 | 266,70 | 279,03 |
| ¾" | CMFF038E | 12 | 171,27 | 183,47 | 203,06 |
| ½" | CMFF012E | 15 | 190,99 | 225,26 | 246,87 |

Válvula de membrana
compacta.

Código en FKM termina en "F" en lugar de "E"
Código en PTFE termina en "P" en lugar de "E"



Sistema PVDF

Válvulas anti-retorno de clapeta



Consultar precios



FROF

| d | Ref. FKM | DN | PN | € FKM | € PTFE |
|-----|----------|-----|----|-----------|-----------|
| 40 | FROF040F | 32 | 6 | 1.096,38 | 1.304,29 |
| 50 | FROF050F | 40 | 6 | 1.104,29 | 1.324,94 |
| 63 | FROF063F | 50 | 6 | 1.179,43 | 1.391,72 |
| 75 | FROF075F | 65 | 6 | 1.204,33 | 1.457,02 |
| 90 | FROF090F | 80 | 6 | 1.776,68 | 2.149,82 |
| 110 | FROF110F | 100 | 6 | 2.192,59 | 2.624,68 |
| 140 | FROF140F | 125 | 6 | 2.424,83 | 2.933,52 |
| 160 | FROF160F | 150 | 6 | 3.910,32 | 4.692,27 |
| 225 | FROF225F | 200 | 6 | 6.850,15 | 8.288,31 |
| 280 | FROF280F | 250 | 6 | 10.312,26 | 12.580,68 |
| 315 | FROF315F | 300 | 6 | 15.608,96 | 19.198,87 |

Válvula anti-retorno de clapeta sin resorte. **ISO/DIN.**

Código en PTFE termina en "P" en lugar de "F"



FROF

| d | Ref. FKM | DN | PN | € FKM | € PTFE |
|-----|-------------|-----|----|-----------|-----------|
| 40 | FROF040FMLX | 32 | 6 | 1.235,59 | 1.443,58 |
| 50 | FROF050FMLX | 40 | 6 | 1.243,50 | 1.464,18 |
| 63 | FROF063FMLX | 50 | 6 | 1.327,57 | 1.539,93 |
| 75 | FROF075FMLX | 65 | 6 | 1.360,56 | 1.613,17 |
| 90 | FROF090FMLX | 80 | 6 | 1.940,83 | 2.314,08 |
| 110 | FROF110FMLX | 100 | 6 | 2.373,74 | 2.805,87 |
| 140 | FROF140FMLX | 125 | 6 | 2.606,00 | 3.114,72 |
| 160 | FROF160FMLX | 150 | 6 | 4.144,00 | 4.925,95 |
| 225 | FROF225FMLX | 200 | 6 | 7.116,87 | 8.555,08 |
| 280 | FROF280FMLX | 250 | 6 | 10.630,97 | 12.899,46 |
| 315 | FROF315FMLX | 300 | 6 | 15.976,79 | 19.566,63 |

Válvula anti-retorno de clapeta con resorte inox. **ISO/DIN.**

Código en PTFE termina en "PMLX" en lugar de "FMLX"



FROAF

| d | Ref. FKM | DN | PN | € FKM | € PTFE |
|-----|-----------|-----|----|-----------|-----------|
| 1¼" | FROAF114F | 32 | 6 | 1.215,38 | 1.472,42 |
| 1½" | FROAF112F | 40 | 6 | 1.209,25 | 1.484,18 |
| 2" | FROAF200F | 50 | 6 | 1.293,17 | 1.574,66 |
| 2½" | FROAF212F | 65 | 6 | 1.312,74 | 1.668,94 |
| 3" | FROAF300F | 80 | 6 | 1.946,85 | 2.362,00 |
| 4" | FROAF400F | 100 | 6 | 2.402,68 | 2.891,93 |
| 5" | FROAF500F | 125 | 6 | 2.641,95 | 3.190,17 |
| 6" | FROAF600F | 150 | 6 | 4.245,02 | 4.884,19 |
| 8" | FROAF800F | 200 | 6 | 7.552,66 | 8.233,85 |
| 10" | FROAF810F | 250 | 6 | 11.208,92 | 12.131,11 |
| 12" | FROAF812F | 300 | 6 | 17.205,74 | 18.302,07 |

Válvula anti-retorno de clapeta sin resorte. **ANSI 150 lbs.**

Código en PTFE termina en "P" en lugar de "F"



FROAF

| d | Ref. FKM | DN | PN | € FKM | € PTFE |
|-----|--------------|-----|----|-----------|-----------|
| 1¼" | FROAF114FMLX | 32 | 6 | 1.354,58 | 1.611,67 |
| 1½" | FROAF112FMLX | 40 | 6 | 1.348,51 | 1.623,41 |
| 2" | FROAF200FMLX | 50 | 6 | 1.440,71 | 1.722,81 |
| 2½" | FROAF212FMLX | 65 | 6 | 1.468,93 | 1.825,11 |
| 3" | FROAF300FMLX | 80 | 6 | 2.111,04 | 2.526,21 |
| 4" | FROAF400FMLX | 100 | 6 | 2.583,96 | 3.073,14 |
| 5" | FROAF500FMLX | 125 | 6 | 2.823,18 | 3.371,29 |
| 6" | FROAF600FMLX | 150 | 6 | 4.478,63 | 5.117,84 |
| 8" | FROAF800FMLX | 200 | 6 | 7.819,38 | 8.500,54 |
| 10" | FROAF810FMLX | 250 | 6 | 11.527,69 | 12.449,85 |
| 12" | FROAF812FMLX | 300 | 6 | 17.573,65 | 18.669,93 |

Válvula anti-retorno de clapeta con resorte inox. **ANSI 150 lbs.**

Código en PTFE termina en "PMLX" en lugar de "FMLX"



INDUSTRIA

Sistema PVDF

Válvulas de bola actuadas



Consultar precios



SRIF

| d | Ref. | DN | PN | € FKM |
|----|----------|----|----|----------|
| 20 | SRIF020F | 15 | 16 | 304,88 |
| 25 | SRIF025F | 20 | 16 | 375,13 |
| 32 | SRIF032F | 25 | 16 | 436,51 |
| 40 | SRIF040F | 32 | 16 | 763,28 |
| 50 | SRIF050F | 40 | 16 | 822,49 |
| 63 | SRIF063F | 50 | 16 | 1.390,50 |

Válvula de bola anti-retorno.

Juntas en FKM.

M-H para fusión socket.

VKDIF/CE

Soldar

ACTUACIÓN ELÉCTRICA
24-240 V AC/DC

ACTUACIÓN ELÉCTRICA CON BLOQUE DE SEGURIDAD
24-240 V AC/DC



| d | Ref. | € | Ref. | € |
|-----|------------|----------|-------------|----------|
| 16 | VKFE016F2D | 1.008,09 | VKFE016F2BD | 1.729,19 |
| 20 | VKFE020F2D | 1.017,79 | VKFE020F2BD | 1.738,88 |
| 25 | VKFE025F2D | 1.085,14 | VKFE025F2BD | 1.806,21 |
| 32 | VKFE032F2D | 1.176,21 | VKFE032F2BD | 1.897,29 |
| 40 | VKFE040F2D | 1.307,51 | VKFE040F2BD | 2.028,59 |
| 50 | VKFE050F2D | 1.543,33 | VKFE050F2BD | 2.264,38 |
| 63 | VKFE063F2D | 1.923,04 | VKFE063F2BD | 2.644,11 |
| 75 | VKFE075F2D | 4.010,67 | VKFE075F2BD | 4.731,75 |
| 90 | VKFE090F2D | 4.782,68 | VKFE090F2BD | 5.503,75 |
| 110 | VKFE110F2D | 6.987,91 | VKFE110F2BD | 7.709,01 |

Válvula de bola motorizada
en PVDF 2 vías DUAL BLOCK®. Actuación eléctrica.

Disponemos de otras conexiones bajo pedido: bridas, soldar macho y roscar (GAS y NPT)

Bajo pedido podemos suministrar otros actuadores: VALPES, BELIMO...

Bajo pedido también disponibles en 12V AC/DC

Consultar precios



VKRIF/CE

Soldar

ACTUACIÓN ELÉCTRICA 24-240 V AC/DC CON POSICIONADOR 4-20 mA

| d | Ref. | € |
|----|-------------|----------|
| 16 | VRFE016F2PD | 1.873,67 |
| 20 | VRFE020F2PD | 1.883,30 |
| 25 | VRFE025F2PD | 1.959,63 |
| 32 | VRFE032F2PD | 2.084,91 |
| 40 | VRFE040F2PD | 2.252,15 |
| 50 | VRFE050F2PD | 2.832,69 |
| 63 | VRFE063F2PD | 3.833,35 |

Válvula de bola **REGULACIÓN** motorizada en PVDF 2 vías DUAL BLOCK®.

Actuación eléctrica con posicionador 4-20 mA.

Disponemos de otras conexiones bajo pedido: bridas, soldar macho y roscar (GAS y NPT)

Bajo pedido podemos suministrar otros actuadores: VALPES, BELIMO...

Bajo pedido también disponibles en 12V AC/DC

VKDIF/CP

Soldar

ACTUACIÓN NEUMÁTICA ALUMINIO

ACTUACIÓN NEUMÁTICA ALUMINIO CON ELECTROVÁLVULA, FINALES DE CARRERA (ELECTROMECAÑICOS) Y REGULADORES DE ESCAPE

| d | DOBLE EFECTO | | SIMPLE EFECTO | | DOBLE EFECTO | | SIMPLE EFECTO | |
|-----|--------------|----------|---------------|----------|--------------|----------|---------------|----------|
| | Ref. | € | Ref. | € | Ref. | € | Ref. | € |
| 16 | VKFP016FDED | 569,49 | VKFP016FSED | 609,43 | VKFP016FDEFD | 830,31 | VKFP016FSEFD | 884,03 |
| 20 | VKFP020FDED | 579,20 | VKFP020FSED | 619,11 | VKFP020FDEFD | 840,02 | VKFP020FSEFD | 893,71 |
| 25 | VKFP025FDED | 646,56 | VKFP025FSED | 686,44 | VKFP025FDEFD | 907,36 | VKFP025FSEFD | 961,04 |
| 32 | VKFP032FDED | 737,61 | VKFP032FSED | 777,53 | VKFP032FDEFD | 998,43 | VKFP032FSEFD | 1.052,12 |
| 40 | VKFP040FDED | 868,91 | VKFP040FSED | 908,82 | VKFP040FDEFD | 1.129,73 | VKFP040FSEFD | 1.183,42 |
| 50 | VKFP050FDED | 1.104,71 | VKFP050FSED | 1.222,18 | VKFP050FDEFD | 1.365,52 | VKFP050FSEFD | 1.496,78 |
| 63 | VKFP063FDED | 1.484,44 | VKFP063FSED | 1.704,44 | VKFP063FDEFD | 1.745,26 | VKFP063FSEFD | 1.979,04 |
| 75 | VKFP075FDED | 3.362,33 | VKFP075FSED | 3.518,00 | VKFP075FDEFD | 3.623,18 | VKFP075FSEFD | 3.792,61 |
| 90 | VKFP090FDED | 4.134,37 | VKFP090FSED | 4.290,00 | VKFP090FDEFD | 4.395,16 | VKFP090FSEFD | 4.564,63 |
| 110 | VKFP110FDED | 5.883,77 | VKFP110FSED | 6.434,62 | VKFP110FDEFD | 6.144,57 | VKFP110FSEFD | 6.709,24 |

Válvula de bola motorizada en PVDF 2 vías DUAL BLOCK®.

Actuación neumática.

Disponemos de otras conexiones bajo pedido: bridas, soldar macho y roscar (NPT)

Las válvulas neumáticas se configuran NC (normalmente cerrada) de serie.

La configuración NA (normalmente abierta) se debe especificar en el pedido

Consultar precios

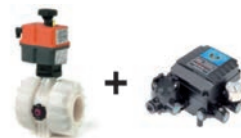

VKRIF/CP

Soldar

ACTUACIÓN NEUMÁTICA ALUMINIO DOBLE EFECTO
CON POSICIONADOR 4-20 mAACTUACIÓN NEUMÁTICA ALUMINIO SIMPLE EFECTO
CON POSICIONADOR 4-20 mA

| d | Ref. | € | Ref. | € |
|----|--------------|----------|--------------|----------|
| 16 | VRFP016FDEPD | 3.155,46 | VRFP016FSEPD | 3.195,37 |
| 20 | VRFP020FDEPD | 3.165,17 | VRFP020FSEPD | 3.205,10 |
| 25 | VRFP025FDEPD | 3.241,41 | VRFP025FSEPD | 3.281,35 |
| 32 | VRFP032FDEPD | 3.366,66 | VRFP032FSEPD | 3.406,60 |
| 40 | VRFP040FDEPD | 3.533,96 | VRFP040FSEPD | 3.573,87 |
| 50 | VRFP050FDEPD | 4.114,52 | VRFP050FSEPD | 4.231,99 |
| 63 | VRFP063FDEPD | 5.115,13 | VRFP063FSEPD | 5.335,17 |

Válvula de bola **REGULACIÓN** motorizada
en PVDF 2 vías DUAL BLOCK®.

Actuación neumática con posicionador 4-20 mA.

Disponemos de otras conexiones bajo pedido: bridas, soldar macho y roscar (NPT)
Las válvulas neumáticas se configuran NC (normalmente cerrada) de serie.
La configuración NA (normalmente abierta) se debe especificar en el pedido.

VKDIF/CP

Soldar

ACTUACIÓN NEUMÁTICA POLIAMIDA

ACTUACIÓN NEUMÁTICA ALUMINIO CON ELECTROVÁLVULA, FINALES
DE CARRERA (ELECTROMECAÑICOS) Y REGULADORES DE ESCAPE

| d | DOBLE EFECTO | | SIMPLE EFECTO | | DOBLE EFECTO | | SIMPLE EFECTO | |
|-----|--------------|----------|---------------|----------|--------------|----------|---------------|----------|
| | Ref. | € | Ref. | € | Ref. | € | Ref. | € |
| 16 | VKFP016FDEP | 593,88 | VKFP016FSEP | 623,97 | VKFP016FDEFP | 935,03 | VKFP016FSEFP | 965,14 |
| 20 | VKFP020FDEP | 603,56 | VKFP020FSEP | 633,66 | VKFP020FDEFP | 944,72 | VKFP020FSEFP | 974,82 |
| 25 | VKFP025FDEP | 947,09 | VKFP025FSEP | 700,95 | VKFP025FDEFP | 1.012,06 | VKFP025FSEFP | 1.042,15 |
| 32 | VKFP032FDEP | 761,97 | VKFP032FSEP | 927,36 | VKFP032FDEFP | 1.103,13 | VKFP032FSEFP | 1.268,55 |
| 40 | VKFP040FDEP | 893,27 | VKFP040FSEP | 1.058,69 | VKFP040FDEFP | 1.234,46 | VKFP040FSEFP | 1.399,87 |
| 50 | VKFP050FDEP | 1.129,03 | VKFP050FSEP | 1.452,35 | VKFP050FDEFP | 1.470,22 | VKFP050FSEFP | 1.793,52 |
| 63 | VKFP063FDEP | 1.774,10 | VKFP063FSEP | 1.860,54 | VKFP063FDEFP | 2.115,29 | VKFP063FSEFP | 2.201,73 |
| 75 | VKFP075FDEP | 3.530,07 | VKFP075FSEP | 3.853,98 | VKFP075FDEFP | 3.871,29 | VKFP075FSEFP | 4.195,12 |
| 90 | VKFP090FDEP | 4.302,08 | VKFP090FSEP | 4.626,02 | VKFP090FDEFP | 4.643,24 | VKFP090FSEFP | 4.967,18 |
| 110 | VKFP110FDEP | 6.008,04 | VKFP110FSEP | 6.359,58 | VKFP110FDEFP | 6.349,21 | VKFP110FSEFP | 6.700,77 |

Válvula de bola motorizada
en PVDF 2 vías DUAL BLOCK®.

Actuación neumática.

Disponemos de otras conexiones bajo pedido: bridas, soldar macho y roscar (GAS y NPT)
Las válvulas neumáticas se configuran NC (normalmente cerrada) de serie.
La configuración NA (normalmente abierta) se debe especificar en el pedido.



INDUSTRIA

Sistema PVDF

Válvulas de mariposa actuadas



Consultar precios

VKRIF/CP

Soldar

ACTUACIÓN NEUMÁTICA POLIAMIDA DOBLE EFECTO
CON POSICIONADOR 4-20 mA

| d | Ref. | € |
|----|--------------|----------|
| 16 | VRFP016FDEPD | 3.155,46 |
| 20 | VRFP020FDEPD | 3.165,17 |
| 25 | VRFP025FDEPD | 3.241,41 |
| 32 | VRFP032FDEPD | 3.366,66 |
| 40 | VRFP040FDEPD | 3.533,96 |
| 50 | VRFP050FDEPD | 4.114,52 |
| 63 | VRFP063FDEP | 5.115,13 |

S
O
L
D
A
R

ACTUACIÓN NEUMÁTICA POLIAMIDA SIMPLE
EFECTO CON POSICIONADOR 4-20 mA

| Ref. | € |
|--------------|----------|
| VRFP016FSEPP | 2.613,96 |
| VRFP020FSEPP | 2.623,67 |
| VRFP025FSEPP | 2.699,89 |
| VRFP032FSEPP | 2.960,48 |
| VRFP040FSEPP | 3.127,78 |
| VRFP050FSEPP | 3.866,24 |
| VRFP063FSEPP | 4.895,31 |

S
O
L
D
A
R

Válvula de bola REGULACIÓN motorizada en PVDF 2 vías DUAL BLOCK®.

Actuación neumática con posicionador 4-20 mA.

Disponemos de otras conexiones bajo pedido: bridas, soldar macho y roscar (NPT)

Las válvulas neumáticas se configuran NC (normalmente cerrada) de serie. La configuración NA (normalmente abierta) se debe especificar en el pedido

FKOF/CE

ACTUACIÓN ELÉCTRICA
24-240 V AC/DC

| d | Ref. | € |
|-----|------------|----------|
| 50 | FKFE050F2D | 1.470,82 |
| 63 | FKFE063F2D | 1.515,32 |
| 75 | FKFE075F2D | 1.941,96 |
| 90 | FKFE090F2D | 2.007,01 |
| 110 | FKFE110F2D | 2.049,89 |
| 125 | FKFE140F2D | 2.853,23 |
| 140 | FKFE140F2D | 2.853,23 |
| 160 | FKFE160F2D | 3.260,10 |
| 200 | FKFE225F2D | 3.869,02 |
| 225 | FKFE225F2D | 3.869,02 |
| 250 | FKFE280F2D | 8.957,76 |
| 280 | FKFE280F2D | 8.957,76 |
| 315 | FKFE315F2D | 9.576,10 |

F
K
M

ACTUACIÓN ELÉCTRICA CON BLOQUE DE SEGURIDAD
24-240 V AC/DC

| Ref. | € |
|-------------|-----------|
| FKFE050F2BD | 2.191,89 |
| FKFE063F2BD | 2.236,42 |
| FKFE075F2BD | 2.663,01 |
| FKFE090F2BD | 2.728,01 |
| FKFE110F2BD | 2.770,94 |
| FKFE140F2BD | 3.574,36 |
| FKFE140F2BD | 3.574,36 |
| FKFE160F2BD | 4.103,91 |
| FKFE225F2BD | 4.712,85 |
| FKFE225F2BD | 4.712,85 |
| FKFE280F2BD | 9.801,56 |
| FKFE280F2BD | 9.801,56 |
| FKFE315F2BD | 10.419,92 |

F
K
M

Válvula de mariposa industrial motorizada cuerpo en PPGR y disco en PVDF.

Actuación eléctrica.

Bajo pedido podemos suministrar otros actuadores: VALPES, BELIMO...
Bajo pedido también disponibles en 12V AC/DC

Consultar precios



FKOF/CP

| d | ACTUACIÓN NEUMÁTICA ALUMINIO | | | | ACTUACIÓN NEUMÁTICA ALUMINIO CON ELECTROVÁLVULA, FINALES DE CARRERA (ELECTROMECAÑICOS) Y REGULADORES DE ESCAPE | | | |
|-----|------------------------------|----------|---------------|-----------|--|----------|---------------|-----------|
| | DOBLE EFECTO | | SIMPLE EFECTO | | DOBLE EFECTO | | SIMPLE EFECTO | |
| | Ref. | € | Ref. | € | Ref. | € | Ref. | € |
| 50 | FKFP050FDED | 1.031,78 | FKFP050FSED | 1.149,25 | FKFP050FDEFD | 1.292,60 | FKFP050FSEFD | 1.423,85 |
| 63 | FKFP063FDED | 1.076,35 | FKFP063FSED | 1.193,80 | FKFP063FDEFD | 1.337,15 | FKFP063FSEFD | 1.468,37 |
| 75 | FKFP075FDED | 1.211,85 | FKFP075FSED | 1.385,43 | FKFP075FDEFD | 1.472,69 | FKFP075FSEFD | 1.659,98 |
| 90 | FKFP090FDED | 1.358,24 | FKFP090FSED | 1.513,87 | FKFP090FDEFD | 1.619,06 | FKFP090FSEFD | 1.788,47 |
| 110 | FKFP110FDED | 1.401,14 | FKFP110FSED | 1.987,08 | FKFP110FDEFD | 1.661,94 | FKFP110FSEFD | 2.261,67 |
| 125 | FKFP140FDED | 1.771,42 | FKFP140FSED | 2.652,02 | FKFP140FDEFD | 2.032,24 | FKFP140FSEFD | 2.926,62 |
| 140 | FKFP140FDED | 1.771,42 | FKFP140FSED | 2.652,02 | FKFP140FDEFD | 2.032,24 | FKFP140FSEFD | 2.926,62 |
| 160 | FKFP160FDED | 1.863,76 | FKFP160FSED | 2.744,38 | FKFP160FDEFD | 2.124,58 | FKFP160FSEFD | 3.018,96 |
| 200 | FKFP225FDED | 2.653,26 | FKFP225FSED | 3.861,86 | FKFP225FDEFD | 2.914,08 | FKFP225FSEFD | 4.136,48 |
| 225 | FKFP225FDED | 2.653,26 | FKFP225FSED | 3.861,86 | FKFP225FDEFD | 2.914,08 | FKFP225FSEFD | 4.136,48 |
| 250 | FKFP280FDED | 7.977,20 | FKFP280FSED | 10.539,42 | FKFP280FDEFD | 8.237,99 | FKFP280FSEFD | 10.814,05 |
| 280 | FKFP280FDED | 7.977,20 | FKFP280FSED | 10.539,42 | FKFP280FDEFD | 8.237,99 | FKFP280FSEFD | 10.814,05 |
| 315 | FKFP315FDED | 8.944,04 | FKFP315FSED | 12.481,49 | FKFP315FDEFD | 9.204,83 | FKFP315FSEFD | 12.756,09 |

Válvula de mariposa industrial motorizada
 cuerpo en PPGR y disco en PVDF.

Actuación neumática.

Las válvulas neumáticas se configuran NC (normalmente cerrada) de serie.
 La configuración NA (normalmente abierta) se debe especificar en el pedido.

FKOF/CP

| d | ACTUACIÓN NEUMÁTICA POLIAMIDA | | | | ACTUACIÓN NEUMÁTICA POLIAMIDA CON ELECTROVÁLVULA, FINALES DE CARRERA (ELECTROMECAÑICOS) Y REGULADORES DE ESCAPE | | | |
|------|-------------------------------|----------|---------------|-----------|---|----------|---------------|-----------|
| | DOBLE EFECTO | | SIMPLE EFECTO | | DOBLE EFECTO | | SIMPLE EFECTO | |
| | Ref. | € | Ref. | € | Ref. | € | Ref. | € |
| 50 | FKFP050FDEP | 1.170,83 | FKFP050FSEP | 1.382,93 | FKFP050FDEFP | 1.511,99 | FKFP050FSEFP | 1.724,15 |
| 63 | FKFP063FDEP | 1.215,38 | FKFP063FSEP | 1.427,48 | FKFP063FDEFP | 1.556,54 | FKFP063FSEFP | 1.768,66 |
| 75 | FKFP075FDEP | 1.304,44 | FKFP075FSEP | 1.516,55 | FKFP075FDEFP | 1.645,63 | FKFP075FSEFP | 1.857,74 |
| 90 | FKFP090FDEP | 1.494,63 | FKFP090FSEP | 1.581,15 | FKFP090FDEFP | 1.835,82 | FKFP090FSEFP | 1.922,29 |
| 110 | FKFP110FDEP | 1.537,53 | FKFP110FSEP | 1.877,82 | FKFP110FDEFP | 1.878,75 | FKFP110FSEFP | 2.219,01 |
| 125 | FKFP140FDEP | 1.854,15 | FKFP140FSEP | 2.584,58 | FKFP140FDEFP | 2.195,29 | FKFP140FSEFP | 2.925,77 |
| 140 | FKFP140FDEP | 1.854,15 | FKFP140FSEP | 2.584,58 | FKFP140FDEFP | 2.195,29 | FKFP140FSEFP | 2.925,77 |
| 160 | FKFP160FDEP | 2.185,23 | FKFP160FSEP | 2.676,92 | FKFP160FDEFP | 2.526,38 | FKFP160FSEFP | 3.018,11 |
| 200 | FKFP225FDEP | 2.629,08 | FKFP225FSEP | 3.643,96 | FKFP225FDEFP | 2.970,26 | FKFP225FSEFP | 3.985,12 |
| 225 | FKFP225FDEP | 2.629,08 | FKFP225FSEP | 3.643,96 | FKFP225FDEFP | 2.970,26 | FKFP225FSEFP | 3.985,12 |
| 250* | FKFP280FDEP | 8.209,46 | FKFP280FSEP | 10.385,08 | FKFP280FDEFP | 8.550,65 | FKFP280FSEFP | 10.726,24 |
| 280* | FKFP280FDEP | 8.209,46 | FKFP280FSEP | 10.385,08 | FKFP280FDEFP | 8.550,65 | FKFP280FSEFP | 10.726,24 |
| 315* | FKFP315FDEP | 8.827,85 | FKFP315FSEP | 11.003,44 | FKFP315FDEFP | 9.169,01 | FKFP315FSEFP | 11.344,63 |

Válvula de mariposa industrial motorizada
 cuerpo en PPGR y disco en PVDF.

Actuación neumática.

Las válvulas neumáticas se configuran NC (normalmente cerrada) de serie.
 La configuración NA (normalmente abierta) se debe especificar en el pedido.

* Actuadores de aluminio



INDUSTRIA

Sistema PVDF

Válvulas de membrana actuadas



Consultar precios

**DK/CP NC**

| d | Modelo | DN | Ref. EPDM | € EPDM |
|-----|------------|-----|------------|-----------|
| 20 | DKDF/CP NC | 15 | DKDFNC020E | 553,88 |
| 25 | DKDF/CP NC | 20 | DKDFNC025E | 577,81 |
| 32 | DKDF/CP NC | 25 | DKDFNC032E | 711,63 |
| 40 | DKDF/CP NC | 32 | DKDFNC040E | 1.060,95 |
| 50 | DKDF/CP NC | 40 | DKDFNC050E | 1.194,39 |
| 63 | DKDF/CP NC | 50 | DKDFNC063E | 1.631,11 |
| 75 | DKDF/CP NC | 65 | DKDFNC075E | 1.957,31 |
| 90 | VMD/CP NC | 80 | VMDFNC090E | 3.830,47 |
| 110 | VMD/CP NC | 100 | VMDFNC110E | 4.817,62 |

**VM/CP NC**

| Ref. FKM | € FKM | Ref. PTFE | € PTFE |
|------------|----------|------------|-----------|
| DKDFNC020F | 636,80 | DKDFNC020P | 667,11 |
| DKDFNC025F | 660,72 | DKDFNC025P | 692,65 |
| DKDFNC032F | 803,64 | DKDFNC032P | 841,23 |
| DKDFNC040F | 1.218,68 | DKDFNC040P | 1.259,98 |
| DKDFNC050F | 1.363,03 | DKDFNC050P | 1.393,54 |
| DKDFNC063F | 1.917,65 | DKDFNC063P | 1.913,51 |
| DKDFNC075F | 2.301,21 | DKDFNC075P | 2.296,21 |
| VMDFNC090F | 4.579,64 | VMDFNC090P | 4.179,67 |
| VMDFNC110F | 5.532,32 | VMDFNC110P | 5.385,28 |

Válvula neumática **NORMALMENTE CERRADA.**

M-M soldar socket.

**DK/CP NO**

| d | Modelo | DN | Ref. EPDM | € EPDM |
|-----|------------|-----|------------|-----------|
| 20 | DKDF/CP NO | 15 | DKDFNO020E | 473,34 |
| 25 | DKDF/CP NO | 20 | DKDFNO025E | 497,34 |
| 32 | DKDF/CP NO | 25 | DKDFNO032E | 544,82 |
| 40 | DKDF/CP NO | 32 | DKDFNO040E | 883,82 |
| 50 | DKDF/CP NO | 40 | DKDFNO050E | 1.005,93 |
| 63 | DKDF/CP NO | 50 | DKDFNO063E | 1.296,75 |
| 75 | DKDF/CP NO | 65 | DKDFNO075E | 1.556,05 |
| 90 | VMD/CP NO | 80 | VMDFNO090E | 3.367,95 |
| 110 | VMD/CP NO | 100 | VMDFNO110E | 4.235,96 |

**VM/CP NO**

| Ref. FKM | € FKM | Ref. PTFE | € PTFE |
|------------|----------|------------|-----------|
| DKDFNO020F | 556,33 | DKDFNO020P | 586,62 |
| DKDFNO025F | 580,23 | DKDFNO025P | 612,18 |
| DKDFNO032F | 870,45 | DKDFNO032P | 911,89 |
| DKDFNO040F | 1.084,78 | DKDFNO040P | 1.135,73 |
| DKDFNO050F | 1.225,91 | DKDFNO050P | 1.286,19 |
| DKDFNO063F | 1.660,77 | DKDFNO063P | 1.655,57 |
| DKDFNO075F | 1.992,93 | DKDFNO075P | 1.986,64 |
| VMDFNO090F | 4.239,69 | VMDFNO090P | 3.772,94 |
| VMDFNO110F | 4.820,40 | VMDFNO110P | 4.861,29 |

Válvula neumática **NORMALMENTE ABIERTA.**

M-M soldar socket.

**DK/CP DE**

| d | Modelo | DN | Ref. EPDM | € EPDM |
|-----|------------|-----|------------|-----------|
| 20 | DKDF/CP DE | 15 | DKDFDA020E | 392,84 |
| 25 | DKDF/CP DE | 20 | DKDFDA025E | 416,82 |
| 32 | DKDF/CP DE | 25 | DKDFDA032E | 648,11 |
| 40 | DKDF/CP DE | 32 | DKDFDA040E | 803,53 |
| 50 | DKDF/CP DE | 40 | DKDFDA050E | 865,52 |
| 63 | DKDF/CP DE | 50 | DKDFDA063E | 866,76 |
| 75 | DKDF/CP DE | 65 | DKDFDA075E | 868,00 |
| 90 | VMD/CP DE | 80 | VMDFDA090E | 3.738,52 |
| 110 | VMD/CP DE | 100 | VMDFDA110E | 4.702,08 |

VM/CP DE

| Ref. FKM | € FKM | Ref. PTFE | € PTFE |
|------------|----------|------------|-----------|
| DKDFDA020F | 475,81 | DKDFDA020P | 506,14 |
| DKDFDA025F | 499,76 | DKDFDA025P | 531,69 |
| DKDFDA032F | 780,89 | DKDFDA032P | 820,03 |
| DKDFDA040F | 986,15 | DKDFDA040P | 1.032,47 |
| DKDFDA050F | 876,68 | DKDFDA050P | 887,84 |
| DKDFDA063F | 877,92 | DKDFDA063P | 889,08 |
| DKDFDA075F | 879,16 | DKDFDA075P | 890,32 |
| VMDFDA090F | 4.610,26 | VMDFDA090P | 4.143,59 |
| VMDFDA110F | 5.241,82 | VMDFDA110P | 5.338,75 |

Válvula neumática **DOBLE EFECTO.**

M-M soldar socket.

Consultar precios



DK/CP NC

| d | Modelo | DN | Ref. EPDM | € EPDM | Ref. FKM | € FKM | Ref. PTFE | € PTFE |
|----|-------------|----|-------------|-----------|-------------|----------|-------------|-----------|
| 20 | DKUIF/CP NC | 15 | DKUIFNC020E | 625,62 | DKUIFNC020F | 707,07 | DKUIFNC020P | 738,95 |
| 25 | DKUIF/CP NC | 20 | DKUIFNC025E | 657,53 | DKUIFNC025F | 740,57 | DKUIFNC025P | 772,50 |
| 32 | DKUIF/CP NC | 25 | DKUIFNC032E | 831,83 | DKUIFNC032F | 923,86 | DKUIFNC032P | 963,26 |
| 40 | DKUIF/CP NC | 32 | DKUIFNC040E | 1.243,03 | DKUIFNC040F | 1.400,78 | DKUIFNC040P | 1.442,10 |
| 50 | DKUIF/CP NC | 40 | DKUIFNC050E | 1.425,96 | DKUIFNC050F | 1.594,57 | DKUIFNC050P | 1.627,09 |
| 63 | DKUIF/CP NC | 50 | DKUIFNC063E | 1.952,14 | DKUIFNC063F | 2.238,48 | DKUIFNC063P | 2.234,41 |

Válvula neumática **NORMALMENTE CERRADA.**

Con enlaces H-H para soldar socket.



DK/CP NO

| d | Modelo | DN | Ref. EPDM | € EPDM | Ref. FKM | € FKM | Ref. PTFE | € PTFE |
|----|-------------|-----|-------------|-----------|-------------|----------|-------------|-----------|
| 20 | DKUIF/CP NO | 15 | DKUIFNO020E | 545,08 | DKUIFNO020F | 626,55 | DKUIFNO020P | 658,43 |
| 25 | DKUIF/CP NO | 20 | DKUIFNO025E | 577,04 | DKUIFNO025F | 660,08 | DKUIFNO025P | 692,01 |
| 32 | DKUIF/CP NO | 25 | DKUIFNO032E | 885,83 | DKUIFNO032F | 1.029,07 | DKUIFNO032P | 1.069,19 |
| 40 | DKUIF/CP NO | 32 | DKUIFNO040E | 1.118,68 | DKUIFNO040F | 1.322,11 | DKUIFNO040P | 1.370,52 |
| 50 | DKUIF/CP NO | *40 | DKUIFNO050E | 1.304,55 | DKUIFNO050F | 1.524,59 | DKUIFNO050P | 1.585,07 |
| 63 | DKUIF/CP NO | *50 | DKUIFNO063E | 1.707,93 | DKUIFNO063F | 2.074,61 | DKUIFNO063P | 2.069,48 |

Válvula neumática **NORMALMENTE ABIERTA.**

* Válvulas NO-DE

Con enlaces H-H para soldar socket.



DK/CP DE

| d | Modelo | DN | Ref. EPDM | € EPDM | Ref. FKM | € FKM | Ref. PTFE | € PTFE |
|----|-------------|-----|-------------|-----------|-------------|----------|-------------|-----------|
| 20 | DKUIF/CP DE | 15 | DKUIFDA020E | 464,63 | DKUIFDA020F | 546,05 | DKUIFDA020P | 577,96 |
| 25 | DKUIF/CP DE | 20 | DKUIFDA025E | 496,54 | DKUIFDA025F | 579,58 | DKUIFDA025P | 611,49 |
| 32 | DKUIF/CP DE | 25 | DKUIFDA032E | 794,70 | DKUIFDA032F | 928,68 | DKUIFDA032P | 966,71 |
| 40 | DKUIF/CP DE | 32 | DKUIFDA040E | 1.017,02 | DKUIFDA040F | 1.201,94 | DKUIFDA040P | 1.245,92 |
| 50 | DKUIF/CP DE | *40 | DKUIFDA050E | 965,96 | DKUIFDA050F | 973,40 | DKUIFDA050P | 980,84 |
| 63 | DKUIF/CP DE | *50 | DKUIFDA063E | 967,20 | DKUIFDA063F | 974,64 | DKUIFDA063P | 982,08 |

Válvula neumática **DOBLE EFECTO.**

Con enlaces H-H para soldar socket.

Consultar precios



DK/CP NC



VM/CP NC

| d | Modelo | DN | € | | € | | € | |
|-----|------------|-----|------------|----------|------------|----------|------------|----------|
| | | | Ref. EPDM | EPDM | Ref. FKM | FKM | Ref. PTFE | PTFE |
| 20 | DKOF/CP NC | 15 | DKOFNC020E | 719,97 | DKOFNC020F | 802,99 | DKOFNC020P | 833,32 |
| 25 | DKOF/CP NC | 20 | DKOFNC025E | 751,13 | DKOFNC025F | 834,09 | DKOFNC025P | 866,02 |
| 32 | DKOF/CP NC | 25 | DKOFNC032E | 925,15 | DKOFNC032F | 1.017,16 | DKOFNC032P | 1.054,72 |
| 40 | DKOF/CP NC | 32 | DKOFNC040E | 1.379,17 | DKOFNC040F | 1.536,97 | DKOFNC040P | 1.578,22 |
| 50 | DKOF/CP NC | 40 | DKOFNC050E | 1.552,76 | DKOFNC050F | 1.721,37 | DKOFNC050P | 1.751,91 |
| 63 | DKOF/CP NC | 50 | DKOFNC063E | 2.120,49 | DKOFNC063F | 2.406,99 | DKOFNC063P | 2.402,84 |
| 75 | DKOF/CP NC | 65 | DKOFNC075E | 2.544,54 | DKOFNC075F | 2.888,36 | DKOFNC075P | 2.883,41 |
| 90 | VMOF/CP NC | 80 | VMOFNC090E | 4.519,93 | VMOFNC090F | 5.269,05 | VMOFNC090P | 4.869,12 |
| 110 | VMOF/CP NC | 100 | VMOFNC110E | 5.684,86 | VMOFNC110F | 6.398,21 | VMOFNC110P | 6.252,00 |

Válvula neumática **NORMALMENTE CERRADA.**

Con bridas DIN.

Disponibles con bridas ANSI 150 libras al mismo precio



DK/CP NO



VM/CP NO

| d | Modelo | DN | € | | € | | € | |
|-----|------------|-----|------------|----------|------------|----------|------------|----------|
| | | | Ref. EPDM | EPDM | Ref. FKM | FKM | Ref. PTFE | PTFE |
| 20 | DKOF/CP NO | 15 | DKOFNO020E | 639,42 | DKOFNO020F | 722,49 | DKOFNO020P | 752,81 |
| 25 | DKOF/CP NO | 20 | DKOFNO025E | 670,63 | DKOFNO025F | 753,58 | DKOFNO025P | 785,51 |
| 32 | DKOF/CP NO | 25 | DKOFNO032E | 990,27 | DKOFNO032F | 1.132,18 | DKOFNO032P | 1.173,63 |
| 40 | DKOF/CP NO | 32 | DKOFNO040E | 1.233,99 | DKOFNO040F | 1.434,87 | DKOFNO040P | 1.485,81 |
| 50 | DKOF/CP NO | 40 | DKOFNO050E | 1.400,06 | DKOFNO050F | 1.620,19 | DKOFNO050P | 1.680,37 |
| 63 | DKOF/CP NO | 50 | DKOFNO063E | 1.834,98 | DKOFNO063F | 2.199,10 | DKOFNO063P | 2.193,83 |
| 75 | DKOF/CP NO | 65 | DKOFNO075E | 2.201,96 | DKOFNO075F | 2.638,91 | DKOFNO075P | 2.632,61 |
| 90 | VMOF/CP NO | 80 | VMOFNO090E | 4.057,41 | VMOFNO090F | 4.929,17 | VMOFNO090P | 4.462,45 |
| 110 | VMOF/CP NO | 100 | VMOFNO110E | 5.103,06 | VMOFNO110F | 5.445,30 | VMOFNO110P | 5.729,79 |

Válvula neumática **NORMALMENTE ABIERTA.**

Con bridas DIN.

Disponibles con bridas ANSI 150 libras al mismo precio



DK/CP DE



VM/CP DE

| d | Modelo | DN | € | | € | | € | |
|-----|------------|-----|------------|----------|------------|----------|------------|----------|
| | | | Ref. EPDM | EPDM | Ref. FKM | FKM | Ref. PTFE | PTFE |
| 20 | DKOF/CP DE | 15 | DKOFDA020E | 558,96 | DKOFDA020F | 641,98 | DKOFDA020P | 672,31 |
| 25 | DKOF/CP DE | 20 | DKOFDA025E | 590,12 | DKOFDA025F | 673,08 | DKOFDA025P | 705,01 |
| 32 | DKOF/CP DE | 25 | DKOFDA032E | 893,89 | DKOFDA032F | 1.026,70 | DKOFDA032P | 1.065,82 |
| 40 | DKOF/CP DE | 32 | DKOFDA040E | 1.121,80 | DKOFDA040F | 1.304,42 | DKOFDA040P | 1.350,72 |
| 50 | DKOF/CP DE | 40 | DKOFDA050E | 1.088,72 | DKOFDA050F | 1.099,88 | DKOFDA050P | 1.111,04 |
| 63 | DKOF/CP DE | 50 | DKOFDA063E | 1.089,96 | DKOFDA063F | 1.101,12 | DKOFDA063P | 1.112,28 |
| 75 | DKOF/CP DE | 65 | DKOFDA075E | 1.091,20 | DKOFDA075F | 1.102,36 | DKOFDA075P | 1.113,52 |
| 90 | VMOF/CP DE | 80 | VMOFDA090E | 4.428,02 | VMOFDA090F | 5.299,74 | VMOFDA090P | 4.833,02 |
| 110 | VMOF/CP DE | 100 | VMOFDA110E | 5.569,26 | VMOFDA110F | 5.854,71 | VMOFDA110P | 6.205,63 |

Válvula neumática **DOBLE EFECTO.**

Con bridas DIN.

Disponibles con bridas ANSI 150 libras al mismo precio

Consultar precios

CMDF/CP NC *M-M para fusión socket*
CMIF/CP NC *H-H para fusión socket*
CMUIF/CP NC *H-H enlaces fusión socket*
CMFF/CP NC *H-H roscar*



| d-Rh | Ref. EPDM | DN | EPDM | FKM | PTFE |
|------|--------------------|----|--------|--------|--------|
| 20 | CMDFNC020E | 15 | 315,42 | 339,88 | 347,32 |
| 16 | CMIFNC016E | 12 | 253,46 | 289,17 | 300,45 |
| 20 | CMIFNC020E | 15 | 274,13 | 307,97 | 321,13 |
| 20 | CMUIFNC020E | 15 | 371,68 | 407,45 | 420,60 |
| 3/8" | CMFFNC038E | 12 | 257,24 | 287,30 | 300,45 |
| 1/2" | CMFFNC012E | 15 | 274,13 | 307,97 | 321,13 |

Válvula de membrana compacta neumática
NORMALMENTE CERRADA

Código en FKM termina en "F" en lugar de "E"
 Código en PTFE termina en "P" en lugar de "E"
 (A) = Juntas en FKM

CMDF/CP NO *M-M para fusión socket*
CMIF/CP NO *H-H para fusión socket*
CMUIF/CP NO *H-H enlaces fusión socket*
CMFF/CP NO *H-H roscar*



| d-Rh | Ref. EPDM | DN | EPDM | FKM | PTFE |
|------|--------------------|----|--------|--------|--------|
| 20 | CMDFNO020E | 15 | 309,85 | 336,14 | 341,73 |
| 16 | CMIFNO016E | 12 | 247,90 | 287,30 | 296,72 |
| 20 | CMIFNO020E | 15 | 268,52 | 306,15 | 317,43 |
| 20 | CMUIFNO020E | 15 | 369,90 | 405,54 | 416,82 |
| 3/8" | CMFFNO038E | 12 | 253,46 | 285,44 | 296,72 |
| 1/2" | CMFFNO012E | 15 | 268,52 | 306,15 | 317,43 |

Válvula de membrana compacta neumática
NORMALMENTE ABIERTA

Código en FKM termina en "F" en lugar de "E"
 Código en PTFE termina en "P" en lugar de "E"
 (A) = Juntas en FKM

CMDF/CP DE *M-M para fusión socket*
CMIF/CP DE *H-H para fusión socket*
CMUIF/CP DE *H-H enlaces fusión socket*
CMFF/CP DE *H-H roscar*



| d-Rh | Ref. EPDM | DN | EPDM | FKM | PTFE |
|------|--------------------|----|--------|--------|--------|
| 20 | CMDFDA020E | 15 | 309,85 | 336,14 | 341,73 |
| 16 | CMIFDA016E | 12 | 247,90 | 287,30 | 296,72 |
| 20 | CMIFDA020E | 15 | 268,52 | 306,15 | 317,43 |
| 20 | CMUIFDA020E | 15 | 369,90 | 405,54 | 416,82 |
| 3/8" | CMFFDA038E | 12 | 253,46 | 285,44 | 296,72 |
| 1/2" | CMFFDA012E | 15 | 268,52 | 306,15 | 317,43 |

Válvula de membrana compacta neumática
DOBLE EFECTO

Código en FKM termina en "F" en lugar de "E"
 Código en PTFE termina en "P" en lugar de "E"
 (A) = Juntas en FKM



INDUSTRIA

Sistema PVDF

Válvulas de control de presión



Consultar precios



VSF

| d | Ref. EPDM | DN | PN | € PTFE |
|----|------------------|----|----|-----------------|
| 16 | VSFBF016P | 10 | 10 | 2.039,48 |
| 20 | VSFBF020P | 15 | 10 | 2.083,12 |
| 25 | VSFBF025P | 20 | 10 | 2.784,97 |
| 32 | VSFBF032P | 25 | 10 | 3.296,88 |
| 40 | VSFBF040P | 32 | 10 | 5.044,94 |
| 50 | VSFBF050P | 40 | 10 | 6.056,40 |
| 63 | VSFBF063P | 50 | 10 | 6.471,52 |

Válvula de sobrepresión-alivio. [Rango de calibración: 0,5 - 10 bars](#)
M-M para soldadura a testa.



VCP

| d | Ref. EPDM | DN | PN | € PTFE |
|----|------------------|----|----|-----------------|
| 16 | VCPBF016P | 10 | 10 | 1.804,18 |
| 20 | VCPBF020P | 15 | 10 | 1.826,14 |
| 25 | VCPBF025P | 20 | 10 | 2.530,56 |
| 32 | VCPBF032P | 25 | 10 | 2.827,61 |
| 40 | VCPBF040P | 32 | 10 | 4.333,73 |
| 50 | VCPBF050P | 40 | 10 | 5.624,47 |
| 63 | VCPBF063P | 50 | 10 | 5.624,47 |

Válvula retenedora de presión. [Rango de calibración: 0,5 - 10 bars](#)
M-M para soldadura a testa.



VPR

| d | Ref. EPDM | DN | PN | € PTFE |
|----|------------------|----|----|------------------|
| 16 | VPRBF016F | 10 | 10 | 2.157,06 |
| 20 | VPRBF020F | 15 | 10 | 2.314,13 |
| 25 | VPRBF025F | 20 | 10 | 3.219,37 |
| 32 | VPRBF032F | 25 | 10 | 3.655,88 |
| 40 | VPRBF040F | 32 | 10 | 3.989,32 |
| 50 | VPRBF050F | 40 | 10 | 4.299,46 |
| 63 | VPRBF063F | 50 | 10 | 14.527,12 |

Válvula reductora de presión. [Rango de calibración: 0,5 - 9 bars](#)
M-M para soldadura a testa.



VPR

| d | Ref. EPDM | DN | PN | € PTFE |
|----|------------------|----|----|-----------------|
| 16 | VPRDF016E | 10 | 10 | 1.165,60 |
| 20 | VPRDF020E | 15 | 10 | 1.166,84 |
| 25 | VPRDF025E | 20 | 10 | 1.168,08 |
| 32 | VPRDF032E | 25 | 10 | 1.169,32 |
| 40 | VPRDF040E | 32 | 10 | 1.170,56 |
| 50 | VPRDF050E | 40 | 10 | 1.171,80 |
| 63 | VPRDF063E | 50 | 10 | 1.173,04 |

Válvula reductora de presión. [Rango de calibración: 0,5 - 9 bars](#)
M-M para fusión socket.



INDUSTRIA

Sistema PVDF Conectores



Consultar precios



MANGUITO

| d | Ref. EPDM | Para válvulas | € |
|-----|-----------|---------------|----------|
| 16 | ENDIF016 | VKD-VKR-SR | 43,52 |
| 20 | ENDIF020 | VKD-VKR-SR | 43,52 |
| 25 | ENDIF025 | VKD-VKR-SR | 56,68 |
| 32 | ENDIF032 | VKD-VKR-SR | 76,17 |
| 40 | ENDIF040 | VKD-VKR-SR | 99,07 |
| 50 | ENDIF050 | VKD-VKR-SR | 117,27 |
| 63 | ENDIF063 | VKD-VKR-SR | 178,81 |
| 75 | ENDIF075 | VKD | 380,69 |
| 90 | ENDIF090 | VKD | 596,78 |
| 110 | ENDIF110 | VKD | 1.054,31 |

Conector final en PVDF.

H para soldar socket.

MANGUITO

| d | Ref. EPDM | Para válvulas | € |
|-----|-----------|---------------|----------|
| 20 | ENDDF020 | VKD-VKR-SR | 43,52 |
| 25 | ENDDF025 | VKD-VKR-SR | 56,68 |
| 32 | ENDDF032 | VKD-VKR-SR | 76,17 |
| 40 | ENDDF040 | VKD-VKR-SR | 99,07 |
| 50 | ENDDF050 | VKD-VKR-SR | 117,27 |
| 63 | ENDDF063 | VKD-VKR-SR | 178,81 |
| 75 | ENDDF075 | VKD | 380,69 |
| 90 | ENDDF090 | VKD | 596,78 |
| 110 | ENDDF110 | VKD | 1.054,31 |

Conector final en PVDF.

M para soldar socket.

MANGUITO

| Rh | Ref. EPDM | Para válvulas | € |
|-----|-----------|---------------|--------|
| ½" | ENDFF012 | VKD-VKR-SR | 43,52 |
| ¾" | ENDFF034 | VKD-VKR-SR | 56,68 |
| 1" | ENDFF100 | VKD-VKR-SR | 76,17 |
| 1¼" | ENDFF114 | VKD-VKR-SR | 99,07 |
| 1½" | ENDFF112 | VKD-VKR-SR | 117,27 |
| 2" | ENDFF200 | VKD-VKR-SR | 178,81 |

Conector final en PVDF.

H rosca GAS.

CVDF

| d | Ref. EPDM | Para válvulas | € |
|-----|-----------|---------------|--------|
| 20 | CVDF21020 | VKD-VKR-SR | 34,54 |
| 25 | CVDF21025 | VKD-VKR-SR | 43,21 |
| 32 | CVDF21032 | VKD-VKR-SR | 46,30 |
| 40 | CVDF21040 | VKD-VKR-SR | 57,68 |
| 50 | CVDF21050 | VKD-VKR-SR | 85,21 |
| 63 | CVDF21063 | VKD-VKR-SR | 115,15 |
| 75 | CVDF21075 | VKD | 314,51 |
| 90 | CVDF21090 | VKD | 396,04 |
| 110 | CVDF21110 | VKD | 577,32 |

Conector final en PVDF SDR21 PN16.

Para soldar a testa o electrofusión.

CVDF

| d | Ref. EPDM | Para válvulas | € |
|----|------------|---------------|--------|
| 20 | QBBFL21020 | CM-DK | 43,96 |
| 25 | QBBFL21025 | CM-DK | 39,95 |
| 32 | QBBFL21032 | CM-DK | 58,92 |
| 40 | QBBFL21040 | CM-DK | 73,42 |
| 50 | QBBFL21050 | CM-DK | 108,44 |
| 63 | QBBFL21063 | CM-DK | 146,55 |

Conector final en PVDF SDR21 PN16.

Para soldar a testa o electrofusión.

MANGUITO

| Rh | Ref. EPDM | Para válvulas | € |
|-----|-----------|---------------|--------|
| ½" | ENDNF012 | VKD-VKR-SR | 44,63 |
| ¾" | ENDNF034 | VKD-VKR-SR | 56,68 |
| 1" | ENDNF100 | VKD-VKR-SR | 76,17 |
| 1¼" | ENDNF114 | VKD-VKR-SR | 99,07 |
| 1½" | ENDNF112 | VKD-VKR-SR | 117,27 |
| 2" | ENDNF200 | VKD-VKR-SR | 178,81 |

Conector final en PVDF.

H rosca NPT.

Tubo y accesorios
Válvulas manuales
Válvulas actuadas



0806

Sistema C-PVC

INDUSTRIA



Más información





Sistema C-PVC





INDUSTRIA

Sistema C-PVC

Tubo y accesorios



GIC

| d | Ref. | PN | €/m. |
|-----|------------|----|--------|
| 16 | PIPEC13016 | 16 | 4,41 |
| 20 | PIPEC13020 | 16 | 6,49 |
| 25 | PIPEC13025 | 16 | 10,20 |
| 32 | PIPEC13032 | 16 | 16,48 |
| 40 | PIPEC13040 | 16 | 25,37 |
| 50 | PIPEC13050 | 16 | 38,71 |
| 63 | PIPEC13063 | 16 | 61,93 |
| 75 | PIPEC13075 | 16 | 87,70 |
| 90 | PIPEC13090 | 16 | 124,61 |
| 110 | PIPEC13110 | 16 | 186,51 |
| 110 | PIPEC21110 | 10 | 113,71 |
| 160 | PIPEC13160 | 16 | 323,90 |
| 160 | PIPEC21160 | 10 | 294,22 |
| 225 | PIPEC21225 | 10 | 805,72 |

Tubo en C-PVC SDR 13,5

Barras de 5 m.

| d | Ref. | Pack | € |
|------|--------|------|----------|
| 16 | GIC016 | 10 | 4,41 |
| 20 | GIC020 | 10 | 4,94 |
| 25 | GIC025 | 10 | 6,21 |
| 32 | GIC032 | 10 | 7,40 |
| 40 | GIC040 | 10 | 9,66 |
| 50 | GIC050 | 5 | 16,87 |
| 63 | GIC063 | 2 | 21,01 |
| 75 | GIC075 | - | 40,10 |
| 90 | GIC090 | - | 53,75 |
| 110 | GIC110 | - | 98,57 |
| 160 | GIC160 | - | 246,36 |
| 225* | GIC225 | - | 1.226,76 |

Codo 90°.

* PN10

H-H encolar.

HIC



| d | Ref. | Pack | € |
|------|--------|------|--------|
| 20 | HIC020 | 10 | 5,92 |
| 25 | HIC025 | 10 | 8,29 |
| 32 | HIC032 | 10 | 10,09 |
| 40 | HIC040 | 5 | 14,55 |
| 50 | HIC050 | 5 | 23,31 |
| 63 | HIC063 | 5 | 35,62 |
| 75 | HIC075 | - | 54,85 |
| 90 | HIC090 | - | 81,25 |
| 110 | HIC110 | - | 132,39 |
| 160 | HIC160 | - | 284,67 |
| 225* | HIC225 | - | 932,72 |

Codo 45°

* PN10

H-H encolar.

TIC



| d | Ref. | Pack | € |
|------|--------|------|----------|
| 16 | TIC016 | 10 | 4,58 |
| 20 | TIC020 | 10 | 5,51 |
| 25 | TIC025 | 10 | 6,85 |
| 32 | TIC032 | 10 | 8,29 |
| 40 | TIC040 | 5 | 11,41 |
| 50 | TIC050 | 5 | 19,19 |
| 63 | TIC063 | 2 | 26,01 |
| 75 | TIC075 | - | 53,75 |
| 90 | TIC090 | - | 77,49 |
| 110 | TIC110 | - | 119,58 |
| 160 | TIC160 | - | 370,49 |
| 225* | TIC225 | - | 1.453,77 |

Te a 90°.

* PN10

H-H-H encolar.



TRIC

| d x dr | Ref. | Pack | € |
|----------|------------|------|--------|
| 25 x 20 | TRIC025020 | 10 | 5,92 |
| 32 x 20 | TRIC032020 | 10 | 10,09 |
| 32 x 25 | TRIC032025 | 10 | 10,09 |
| 40 x 20 | TRIC040020 | 10 | 14,16 |
| 40 x 25 | TRIC040025 | 10 | 14,16 |
| 50 x 25 | TRIC050025 | 10 | 23,31 |
| 50 x 32 | TRIC050032 | 10 | 23,31 |
| 63 x 25 | TRIC063025 | 5 | 33,81 |
| 63 x 32 | TRIC063032 | 5 | 33,81 |
| 75 x 25 | TRIC075025 | - | 65,08 |
| 90 x 25 | TRIC090025 | - | 80,99 |
| 110 x 25 | TRIC110025 | - | 103,88 |

Te a 90° reducida.

H-H-H encolar.



TIMC

| d x Rh | Ref. | Pack | € |
|-------------|------------|------|-------|
| 16 x 3/8" | TIMC016038 | 10 | 10,09 |
| 20 x 1/2" | TIMC020012 | 10 | 10,97 |
| 25 x 3/4" | TIMC025034 | 10 | 11,41 |
| 32 x 1" | TIMC032100 | 10 | 14,16 |
| 40 x 1 1/4" | TIMC040114 | 10 | 17,23 |
| 50 x 1 1/2" | TIMC050112 | 10 | 26,42 |
| 63 x 2" | TIMC063200 | 5 | 32,91 |

Te a 90° mixta reforzada inox.

H-H-H encolar-rosca.



MIMC

| d x Rh | Ref. | Pack | € |
|-------------|------------|------|-------|
| 16 x 3/8" | MIMC016038 | 10 | 6,49 |
| 20 x 1/2" | MIMC020012 | 10 | 6,85 |
| 25 x 3/4" | MIMC025034 | 10 | 7,73 |
| 32 x 1" | MIMC032100 | 10 | 9,61 |
| 40 x 1 1/4" | MIMC040114 | 5 | 13,21 |
| 50 x 1 1/2" | MIMC050112 | 5 | 17,23 |
| 63 x 2" | MIMC063200 | 5 | 22,85 |

Manguito mixto reforzado inox.

H-H encolar-rosca.



MIC

| d | Ref. | Pack | € |
|------|--------|------|--------|
| 16 | MIC016 | 10 | 3,19 |
| 20 | MIC020 | 10 | 3,69 |
| 25 | MIC025 | 10 | 4,12 |
| 32 | MIC032 | 10 | 5,05 |
| 40 | MIC040 | 5 | 5,51 |
| 50 | MIC050 | 5 | 9,17 |
| 63 | MIC063 | 2 | 14,16 |
| 75 | MIC075 | - | 21,01 |
| 90 | MIC090 | - | 35,62 |
| 110 | MIC110 | - | 64,79 |
| 160 | MIC160 | - | 151,41 |
| 225* | MIC225 | - | 676,43 |

Manguito.

H-H encolar.

* PN10



GIMC

| d x Rh | Ref. | Pack | € |
|-------------|------------|------|-------|
| 16 x 3/8" | GIMC016038 | 10 | 6,70 |
| 20 x 1/2" | GIMC020012 | 10 | 8,01 |
| 25 x 3/4" | GIMC025034 | 10 | 9,17 |
| 32 x 1" | GIMC032100 | 10 | 13,21 |
| 40 x 1 1/4" | GIMC040114 | 10 | 16,38 |
| 50 x 1 1/2" | GIMC050112 | 10 | 23,69 |
| 63 x 2" | GIMC063200 | 5 | 32,03 |

Codo a 90° mixto reforzado inox.

H-H encolar-rosca.



KIFC

| dm x dh x Rm | Ref. | Pack | € |
|------------------|--------------|------|-------|
| 20 x 16 x 3/8" | KIFC20016038 | 10 | 5,51 |
| 25 x 20 x 1/2" | KIFC25020012 | 10 | 6,44 |
| 32 x 25 x 3/4" | KIFC32025034 | 10 | 6,85 |
| 40 x 32 x 1" | KIFC40032100 | 10 | 8,29 |
| 50 x 40 x 1 1/4" | KIFC50040114 | 5 | 10,09 |
| 63 x 50 x 1 1/2" | KIFC63050112 | 5 | 11,88 |
| 75 x 63 x 2" | KIFC75063200 | - | 20,14 |

Terminal rosca macho.

M-H encolar - M rosca

DIC



| d x dr | Ref. | Pack | € |
|------------|-----------|------|--------|
| 20 x 16 | DIC020016 | 10 | 3,81 |
| 25 x 20 | DIC025020 | 10 | 4,41 |
| 32 x 20 | DIC032020 | 10 | 5,13 |
| 32 x 25 | DIC032025 | 10 | 5,13 |
| 40 x 20 | DIC040020 | 10 | 8,29 |
| 40 x 25 | DIC040025 | 10 | 8,29 |
| 40 x 32 | DIC040032 | 10 | 8,29 |
| 50 x 32 | DIC050032 | 10 | 8,53 |
| 50 x 40 | DIC050040 | 10 | 8,53 |
| 63 x 32 | DIC063032 | 5 | 13,58 |
| 63 x 40 | DIC063040 | 5 | 13,58 |
| 63 x 50 | DIC063050 | 5 | 13,58 |
| 75 x 50 | DIC075050 | 5 | 21,53 |
| 75 x 63 | DIC075063 | - | 21,53 |
| 90 x 50 | DIC090050 | - | 30,06 |
| 90 x 63 | DIC090063 | - | 30,06 |
| 90 x 75 | DIC090075 | - | 30,06 |
| 110 x 63 | DIC110063 | - | 46,17 |
| 110 x 75 | DIC110075 | - | 46,17 |
| 110 x 90 | DIC110090 | - | 46,17 |
| 160 x 110 | DIC160110 | - | 114,02 |
| 225 x 160* | DIC225160 | - | 466,78 |

Casquillo reducción. * PN10
M-H encolar.

CIC



| d | Ref. | Pack | € |
|-----|--------|------|-------|
| 20 | CIC020 | 10 | 3,71 |
| 25 | CIC025 | 10 | 6,00 |
| 32 | CIC032 | 10 | 7,86 |
| 40 | CIC040 | 10 | 10,43 |
| 50 | CIC050 | 10 | 16,63 |
| 63 | CIC063 | 5 | 19,19 |
| 75 | CIC075 | - | 30,33 |
| 90 | CIC090 | - | 43,24 |
| 110 | CIC110 | - | 58,09 |

Tapón hembra.
H encolar.



| Ref. | Producto | € |
|---------|---------------------------------|-------|
| TG724 | 1) Cola TEMPERGLUE 724 | 58,43 |
| PCP70 | 1) Decapante Primer Cleaner P70 | 24,62 |
| TGBISON | 2) Cola TEMPERGLUE 100 | 58,43 |
| PCBISON | 2) Decapante TEMPERFIP 100 | 24,62 |

Cola y decapante. 1) TEMPERGLUE 724 debe utilizarse con PRIMER CLEANER P70. Cola especialmente recomendada para la unión de piezas de C-PVC en contacto con fluidos químicamente agresivos (como ácidos y bases). 2) TEMPERGLUE 100 debe utilizarse con TEMPERFIP 100.

QRC



| d | Ref. | DN | Pack | € |
|------|--------|-----|------|--------|
| 20 | QRC020 | 15 | 10 | 5,95 |
| 25 | QRC025 | 20 | 10 | 7,31 |
| 32 | QRC032 | 25 | 10 | 8,70 |
| 40 | QRC040 | 32 | 5 | 10,09 |
| 50 | QRC050 | 40 | 5 | 10,54 |
| 63 | QRC063 | 50 | 2 | 12,75 |
| 75 | QRC075 | 65 | - | 19,19 |
| 90 | QRC090 | 80 | - | 28,22 |
| 110 | QRC110 | 100 | - | 43,83 |
| 160 | QRC160 | 150 | - | 151,41 |
| 225* | QRC225 | 200 | - | 584,76 |

Manguito portabridas. * PN10
H encolar. Para usar con brida ODC.

ODC



| d | Ref. | DN | Pack | € |
|-----|--------|-----|------|-------|
| 20 | ODC020 | 15 | 2 | 7,31 |
| 25 | ODC025 | 20 | 2 | 8,70 |
| 32 | ODC032 | 25 | 2 | 10,09 |
| 40 | ODC040 | 32 | 2 | 12,34 |
| 50 | ODC050 | 40 | 2 | 15,94 |
| 63 | ODC063 | 50 | 2 | 17,75 |
| 75 | ODC075 | 65 | 2 | 26,42 |
| 90 | ODC090 | 80 | 2 | 29,20 |
| 110 | ODC110 | 100 | 2 | 40,10 |

Brida loca.
UNI 2223 PN10/16. Para usar con portabridas QRC.

ODB



| d | Ref. | DN | € |
|-----|--------|-----|-------|
| 20 | ODB020 | 15 | 8,85 |
| 25 | ODB025 | 20 | 9,72 |
| 32 | ODB032 | 25 | 12,51 |
| 40 | ODB040 | 32 | 15,18 |
| 50 | ODB050 | 40 | 17,75 |
| 63 | ODB063 | 50 | 22,08 |
| 75 | ODB075 | 65 | 24,40 |
| 90 | ODB090 | 80 | 29,06 |
| 125 | ODB125 | 100 | 35,07 |

Brida loca. Más diámetros en página 320.
En PP con alma de acero.
PN10. Para manguito portabridas.
Versión ANSI 150 lbs (ver OAB página 320).
Descuento de la familia PP-H.



INDUSTRIA

Sistema C-PVC Uniones 3 piezas



BIC



| d | Ref. EPDM | Pack | € EPDM | € FKM |
|----|----------------|------|--------------|----------|
| 16 | BIC016E | 10 | 16,38 | - |
| 20 | BIC020E | 10 | 18,31 | - |
| 25 | BIC025E | 10 | 19,72 | - |
| 32 | BIC032E | 10 | 23,69 | - |
| 40 | BIC040E | 10 | 32,03 | - |
| 50 | BIC050E | 10 | 44,29 | - |
| 63 | BIC063E | 2 | 62,93 | - |

Unión 3 piezas.

Junta en EPDM ó FKM.
H-H encolar.

Código en FKM termina en "F"
en lugar de "E"

BIFC



| d x Rh | Ref. | Pack | € EPDM |
|-------------|--------------------|------|--------------|
| 16 x 3/8" | BIFC016038E | 10 | 26,42 |
| 20 x 1/2" | BIFC020012E | 10 | 29,20 |
| 25 x 3/4" | BIFC025034E | 10 | 31,09 |
| 32 x 1" | BIFC032100E | 2 | 34,69 |
| 40 x 1 1/4" | BIFC040114E | 2 | 56,68 |
| 50 x 1 1/2" | BIFC050112E | 2 | 81,25 |
| 63 x 2" | BIFC063200E | 2 | 91,36 |

Unión 3 piezas mixto.

Junta en EPDM
H-H encolar-roskar.

BIFOC



| d x Rh | Ref. | Pack | Pack | U/ U | € EPDM |
|-------------|---------------------|------|------|---------|---------------|
| 16 x 3/8" | BIFOC016038E | 16 | 50 | 100 | 33,97 |
| 20 x 1/2" | BIFOC020012E | 16 | 40 | 80 | 40,79 |
| 25 x 3/4" | BIFOC025034E | 16 | 20 | 40 | 53,77 |
| 32 x 1" | BIFOC032100E | 16 | 14 | 28 | 63,50 |
| 40 x 1 1/4" | BIFOC040114E | 16 | 8 | 16 | 88,66 |
| 50 x 1 1/2" | BIFOC050112E | 16 | 4 | 8 | 108,39 |
| 63 x 2" | BIFOC063200E | 16 | - | 12 | 141,96 |

Unión 3 piezas mixto C-PVC / Latón.

Junta en EPDM.
H-M encolar-roskar latón.

BIROC



| d x Rm | Ref. | Pack | Pack | U/ U | € EPDM |
|-------------|---------------------|------|------|---------|---------------|
| 16 x 3/8" | BIROC016038E | 16 | 50 | 100 | 36,93 |
| 20 x 1/2" | BIROC020012E | 16 | 35 | 70 | 44,70 |
| 25 x 3/4" | BIROC025034E | 16 | 15 | 30 | 56,50 |
| 32 x 1" | BIROC032100E | 16 | 12 | 24 | 73,26 |
| 40 x 1 1/4" | BIROC040114E | 16 | 8 | 16 | 104,13 |
| 50 x 1 1/2" | BIROC050112E | 16 | 4 | 8 | 127,60 |
| 63 x 2" | BIROC063200E | 16 | - | 10 | 160,76 |

Unión 3 piezas mixto C-PVC / Latón.

Junta en EPDM.
H-M encolar-roskar latón.



INDUSTRIA

Sistema C-PVC

Válvulas de bola



VKDIC

| d | Ref. EPDM | DN | PN | € EPDM | € FKM |
|----|-----------|----|----|-----------|----------|
| 16 | VKDIC016E | 10 | 16 | 97,62 | 126,84 |
| 20 | VKDIC020E | 15 | 16 | 97,62 | 126,84 |
| 25 | VKDIC025E | 20 | 16 | 105,91 | 136,97 |
| 32 | VKDIC032E | 25 | 16 | 126,84 | 154,29 |
| 40 | VKDIC040E | 32 | 16 | 147,75 | 174,22 |
| 50 | VKDIC050E | 40 | 16 | 179,20 | 219,94 |
| 63 | VKDIC063E | 50 | 16 | 226,58 | 284,67 |

Válvula de bola DUAL BLOCK®
Asiento PTFE (teflón). Bidireccional.
H-H encolar.

Código en FKM termina en "F"
en lugar de "E"



VKDOC

| d | Ref. EPDM | DN | PN | € EPDM | € FKM |
|----|-----------|----|----|-----------|----------|
| 20 | VKDOC020E | 15 | 16 | 207,08 | 254,70 |
| 25 | VKDOC025E | 20 | 16 | 218,91 | 264,02 |
| 32 | VKDOC032E | 25 | 16 | 248,02 | 288,17 |
| 40 | VKDOC040E | 32 | 16 | 340,05 | 378,58 |
| 50 | VKDOC050E | 40 | 16 | 394,52 | 448,85 |
| 63 | VKDOC063E | 50 | 16 | 464,61 | 548,15 |

Válvula de bola DUAL BLOCK®
Asiento PTFE (teflón). Bidireccional.
Con brida loca.

Código en FKM termina en "F"
en lugar de "E"
Versión con bridas ANSI 150 lbs
al mismo precio



VKDIC

| d | Ref. EPDM | DN | PN | € EPDM | € FKM |
|-----|-----------|-----|----|-----------|----------|
| 75 | VKDIC075E | 65 | 16 | 663,87 | 858,61 |
| 90 | VKDIC090E | 80 | 16 | 870,97 | 1.101,33 |
| 110 | VKDIC110E | 100 | 16 | 1.050,86 | 1.281,25 |

Válvula de bola DUAL BLOCK®
Asiento PTFE (teflón). Bidireccional.
H-H encolar.

Código en FKM termina en "F"
en lugar de "E"



VKDOC

| d | Ref. EPDM | DN | PN | € EPDM | € FKM |
|-----|-----------|-----|----|-----------|----------|
| 75 | VKDOC075E | 65 | 16 | 995,75 | 1.190,53 |
| 90 | VKDOC090E | 80 | 16 | 1.306,50 | 1.536,86 |
| 110 | VKDOC110E | 100 | 16 | 1.576,29 | 1.806,65 |

Válvula de bola DUAL BLOCK®
Asiento PTFE (teflón). Bidireccional.
Con brida loca DIN y ANSI.

Código en FKM termina en "F"
en lugar de "E"



VKDDC

| d | Ref. EPDM | DN | PN | € EPDM | € FKM |
|----|-----------|----|----|-----------|----------|
| 20 | VKDDC020E | 15 | 16 | 112,22 | 141,52 |
| 25 | VKDDC025E | 20 | 16 | 121,42 | 144,20 |
| 32 | VKDDC032E | 25 | 16 | 146,00 | 175,03 |
| 40 | VKDDC040E | 32 | 16 | 169,72 | 196,19 |
| 50 | VKDDC050E | 40 | 16 | 196,19 | 245,48 |
| 63 | VKDDC063E | 50 | 16 | 254,87 | 316,67 |

Válvula de bola DUAL BLOCK®
Asiento PTFE (teflón). Bidireccional.
M-M encolar.

Código en FKM termina en "F"
en lugar de "E"



VXEIC

| d | Ref. EPDM | DN | PN | U/ | € EPDM | € FKM |
|----|-----------|----|----|-----|-----------|----------|
| 16 | VXEIC016E | 10 | 16 | 100 | 60,72 | 78,81 |
| 20 | VXEIC020E | 15 | 16 | 80 | 60,72 | 78,81 |
| 25 | VXEIC025E | 20 | 16 | 40 | 65,71 | 85,02 |
| 32 | VXEIC032E | 25 | 16 | 28 | 74,29 | 90,50 |
| 40 | VXEIC040E | 32 | 16 | 16 | 90,41 | 106,66 |
| 50 | VXEIC050E | 40 | 16 | 8 | 104,65 | 128,52 |
| 63 | VXEIC063E | 50 | 16 | 12 | 141,52 | 178,06 |

Válvula de bola maneta naranja.
Asiento PTFE (teflón). Bidireccional.
H-H encolar.

Código en FKM termina en "F"
en lugar de "E"

Disponemos de manguitos
roscados para estas válvulas



VKDDC

| d | Ref. EPDM | DN | PN | € EPDM | € FKM |
|-----|-----------|-----|----|-----------|----------|
| 75 | VKDDC075E | 65 | 16 | 730,20 | 925,02 |
| 90 | VKDDC090E | 80 | 16 | 958,11 | 1.188,52 |
| 110 | VKDDC110E | 100 | 16 | 1.155,92 | 1.386,31 |

Válvula de bola DUAL BLOCK®
Asiento PTFE (teflón). Bidireccional.
M-M encolar.

Código en FKM termina en "F"
en lugar de "E"



VXEIC

| d | Ref. EPDM | DN | PN | € EPDM | € FKM |
|-----|-----------|-----|----|-----------|----------|
| 75 | VXEIC075E | 65 | 16 | 435,72 | 515,16 |
| 90 | VXEIC090E | 80 | 16 | 562,95 | 659,29 |
| 110 | VXEIC110E | 100 | 16 | 792,59 | 947,74 |

Válvula de bola maneta naranja.
Asiento PTFE (teflón). Bidireccional.
H-H encolar.

Código en FKM termina en "F"
en lugar de "E"

Disponemos de manguitos
roscados para estas válvulas



TKDIC

| d | Ref. EPDM | DN | PN | € EPDM | € FKM |
|----|-----------|----|----|-----------|----------|
| 16 | TKDIC016E | 10 | 16 | 185,50 | 200,78 |
| 20 | TKDIC020E | 15 | 16 | 185,50 | 200,78 |
| 25 | TKDIC025E | 20 | 16 | 201,24 | 221,55 |
| 32 | TKDIC032E | 25 | 16 | 240,90 | 266,13 |
| 40 | TKDIC040E | 32 | 16 | 298,16 | 334,65 |
| 50 | TKDIC050E | 40 | 16 | 331,59 | 392,87 |
| 63 | TKDIC063E | 50 | 16 | 421,71 | 499,09 |

Válvula de bola 3 vías
DUAL BLOCK®. PASO T.
Asiento PTFE (teflón). H-H-H encolar.

Código en FKM termina en "F"
en lugar de "E"

Disponemos de manguitos
roscados para estas válvulas



LKDIC

| d | Ref. EPDM | DN | PN | € EPDM | € FKM |
|----|-----------|----|----|-----------|----------|
| 16 | LKDIC016E | 10 | 16 | 213,34 | 228,59 |
| 20 | LKDIC020E | 15 | 16 | 213,34 | 228,59 |
| 25 | LKDIC025E | 20 | 16 | 231,42 | 251,76 |
| 32 | LKDIC032E | 25 | 16 | 277,00 | 302,31 |
| 40 | LKDIC040E | 32 | 16 | 342,87 | 379,38 |
| 50 | LKDIC050E | 40 | 16 | 381,25 | 442,62 |
| 63 | LKDIC063E | 50 | 16 | 485,01 | 562,38 |

Válvula de bola 3 vías
DUAL BLOCK®. PASO L.
Asiento PTFE (teflón). H-H-H encolar.

Código en FKM termina en "F"
en lugar de "E"

Disponemos de manguitos
roscados para estas válvulas



INDUSTRIA

Sistema C-PVC

Válvulas de mariposa



FKOC/FM

| d | Ref. EPDM | DN | € EPDM | € FKM |
|-------|------------|-----|----------|----------|
| 50 | FKOCFM050E | 40 | 347,50 | 515,05 |
| 63 | FKOCFM063E | 50 | 367,98 | 545,29 |
| 75 | FKOCFM075E | 65 | 408,86 | 605,93 |
| 90 | FKOCFM090E | 80 | 444,43 | 650,38 |
| 110 | FKOCFM110E | 100 | 482,92 | 696,28 |
| 125 | FKOCFM140E | 125 | 641,47 | 931,81 |
| 140 | FKOCFM140E | 125 | 641,47 | 931,81 |
| 160 | FKOCFM160E | 150 | 708,14 | 997,04 |
| 200 | FKOCFM225E | 200 | 916,99 | 1.293,29 |
| 225 | FKOCFM225E | 200 | 916,99 | 1.293,29 |
| 250** | FKOCFM280E | 250 | 2.921,69 | 4.649,20 |
| 280** | FKOCFM280E | 250 | 2.921,69 | 4.649,20 |
| 315** | FKOCFM315E | 300 | 3.185,50 | 5.070,03 |

Válvula de mariposa industrial.

A EJE LIBRE.

Para actuar. Cuerpo en PPGR,
eje inoxidable y disco en C-PVC.

Código en FKM termina en "F"
en lugar de "E"

** ANSI 150 lbs bajo pedido
al mismo precio.



FKOC/RM

| d | Ref. EPDM | DN | € EPDM | € FKM |
|-------|------------|-----|----------|----------|
| 75 | FKOCRM075E | 65 | 1.076,99 | 1.269,54 |
| 90 | FKOCRM090E | 80 | 1.099,20 | 1.300,65 |
| 110 | FKOCRM110E | 100 | 1.145,14 | 1.351,04 |
| 125 | FKOCRM140E | 125 | 1.324,36 | 1.608,78 |
| 140 | FKOCRM140E | 125 | 1.324,36 | 1.608,78 |
| 160 | FKOCRM160E | 150 | 1.382,18 | 1.645,75 |
| 200 | FKOCRM225E | 200 | 1.749,58 | 2.091,74 |
| 225 | FKOCRM225E | 200 | 1.749,58 | 2.091,74 |
| 250** | FKOCRM280E | 250 | 3.345,47 | 5.073,02 |
| 280** | FKOCRM280E | 250 | 3.345,47 | 5.073,02 |
| 315** | FKOCRM315E | 300 | 3.609,17 | 5.493,75 |

Válvula de mariposa industrial.

CON VOLANTE.

Cuerpo en PPGR,
eje inoxidable y disco en C-PVC.

Código en FKM termina en "F"
en lugar de "E"

** ANSI 150 lbs bajo pedido
al mismo precio.



FKOC/LM

| d | Ref. EPDM | DN | € EPDM | € FKM |
|-----|------------|-----|----------|----------|
| 50 | FKOCLM050E | 40 | 408,01 | 571,68 |
| 63 | FKOCLM063E | 50 | 431,96 | 605,32 |
| 75 | FKOCLM075E | 65 | 479,95 | 672,56 |
| 90 | FKOCLM090E | 80 | 505,15 | 706,61 |
| 110 | FKOCLM110E | 100 | 548,15 | 755,52 |
| 125 | FKOCLM140E | 125 | 728,87 | 1.013,28 |
| 140 | FKOCLM140E | 125 | 728,87 | 1.013,28 |
| 160 | FKOCLM160E | 150 | 786,63 | 1.050,33 |
| 200 | FKOCLM225E | 200 | 1.017,69 | 1.361,39 |
| 225 | FKOCLM225E | 200 | 1.017,69 | 1.361,39 |

Válvula de mariposa industrial.

CON MANETA.

Cuerpo en PPGR,
eje inoxidable y disco en C-PVC.

Código en FKM termina en "F"
en lugar de "E"



FKOC/FM

| d | Ref. EPDM | DN | € EPDM | € FKM |
|-----|-------------|-----|----------|----------|
| 75 | FKOLCFM075E | 65 | 601,28 | 801,27 |
| 90 | FKOLCFM090E | 80 | 694,54 | 903,47 |
| 110 | FKOLCFM110E | 100 | 754,58 | 971,11 |
| 125 | FKOLCFM140E | 125 | 1.004,14 | 1.298,80 |
| 140 | FKOLCFM140E | 125 | 1.004,14 | 1.298,80 |
| 160 | FKOLCFM160E | 150 | 1.100,38 | 1.393,52 |
| 200 | FKOLCFM225E | 200 | 1.325,88 | 1.707,68 |
| 225 | FKOLCFM225E | 200 | 1.325,88 | 1.707,68 |

Válvula de mariposa industrial.

A EJE LIBRE. LUG ISO-DIN.

Para actuar. Cuerpo en PPGR,
eje inoxidable y disco en C-PVC.

Código en FKM termina en "F"
en lugar de "E"



FKOC/LM

| d | Ref. EPDM | DN | € EPDM | € FKM |
|-----|-------------|-----|-----------|----------|
| 75 | FKOLCLM075E | 65 | 663,71 | 856,22 |
| 90 | FKOLCLM090E | 80 | 745,11 | 946,60 |
| 110 | FKOLCLM110E | 100 | 808,84 | 1.016,24 |
| 125 | FKOLCLM140E | 125 | 1.076,99 | 1.361,39 |
| 140 | FKOLCLM140E | 125 | 1.076,99 | 1.361,39 |
| 160 | FKOLCLM160E | 150 | 1.162,95 | 1.426,63 |
| 200 | FKOLCLM225E | 200 | 1.407,27 | 1.750,97 |
| 225 | FKOLCLM225E | 200 | 1.407,27 | 1.750,97 |

Válvula de mariposa industrial.

CON MANETA. LUG ISO-DIN.

Cuerpo en PPGR,

eje inoxidable y disco en C-PVC.

Código en FKM termina en "F"
en lugar de "E"



FKOC/RM

| d | Ref. EPDM | DN | € EPDM | € FKM |
|-----|-------------|-----|-----------|----------|
| 75 | FKOLCRM075E | 65 | 1.260,64 | 1.453,20 |
| 90 | FKOLCRM090E | 80 | 1.339,19 | 1.540,61 |
| 110 | FKOLCRM110E | 100 | 1.405,87 | 1.611,76 |
| 125 | FKOLCRM140E | 125 | 1.672,45 | 1.956,90 |
| 140 | FKOLCRM140E | 125 | 1.672,45 | 1.956,90 |
| 160 | FKOLCRM160E | 150 | 1.758,43 | 2.022,08 |
| 200 | FKOLCRM225E | 200 | 2.139,12 | 2.481,30 |
| 225 | FKOLCRM225E | 200 | 2.139,12 | 2.481,30 |

Válvula de mariposa industrial.

CON VOLANTE. LUG ISO-DIN.

Cuerpo en PPGR,

eje inoxidable y disco en C-PVC.

Código en FKM termina en "F"
en lugar de "E"



FKOC/RM

| d | Ref. EPDM | DN | € EPDM | € FKM |
|-----|--------------|-----|-----------|----------|
| 2½" | FKOALCRM212E | 65 | 1.352,47 | 1.545,13 |
| 3" | FKOALCRM300E | 80 | 1.435,45 | 1.636,91 |
| 4" | FKOALCRM400E | 100 | 1.511,04 | 1.716,93 |
| 5" | FKOALCRM500E | 125 | 1.811,74 | 2.096,15 |
| 6" | FKOALCRM600E | 150 | 1.909,52 | 2.173,20 |
| 8" | FKOALCRM800E | 200 | 2.333,14 | 2.675,36 |
| 10" | FKOALCRM810E | 250 | 5.213,20 | 6.940,72 |
| 12" | FKOALCRM812E | 300 | 5.519,69 | 7.404,28 |

Válvula de mariposa industrial.

CON VOLANTE. LUG ANSI.

Cuerpo en PPGR, eje inoxidable
y disco en C-PVC.

Código en FKM termina en "F"
en lugar de "E"



FKOC/LM

| d | Ref. EPDM | DN | € EPDM | € FKM |
|-----|--------------|-----|-----------|----------|
| 2½" | FKOALCLM212E | 65 | 755,52 | 948,05 |
| 3" | FKOALCLM300E | 80 | 841,43 | 1.042,92 |
| 4" | FKOALCLM400E | 100 | 913,98 | 1.121,40 |
| 5" | FKOALCLM500E | 125 | 1.216,21 | 1.500,68 |
| 6" | FKOALCLM600E | 150 | 1.313,99 | 1.577,72 |
| 8" | FKOALCLM800E | 200 | 1.601,31 | 1.945,01 |

Válvula de mariposa industrial.

CON MANETA. LUG ANSI.

Cuerpo en PPGR,

eje inoxidable y disco en C-PVC.

Código en FKM termina en "F"
en lugar de "E"



DKDC

| d | Ref. EPDM | DN | PN | € | | |
|----|-----------------|----|----|--------|--------|--------|
| | | | | EPDM | FKM | PTFE |
| 20 | DKDC020E | 15 | 10 | 140,93 | 266,90 | 266,90 |
| 25 | DKDC025E | 20 | 10 | 157,98 | 291,37 | 291,37 |
| 32 | DKDC032E | 25 | 10 | 184,30 | 312,09 | 312,09 |
| 40 | DKDC040E | 32 | 10 | 220,06 | 413,58 | 413,58 |
| 50 | DKDC050E | 40 | 10 | 282,07 | 473,73 | 473,73 |
| 63 | DKDC063E | 50 | 10 | 336,53 | 654,20 | 654,20 |
| 75 | DKDC075E | 65 | 10 | 403,84 | 785,05 | 785,05 |

Válvula de membrana
DIALOCK®.
M-M encolar.

Código en FKM termina en "F"
en lugar de "E"
Código en PTFE termina en "P"
en lugar de "E"



DKOC

| d | Ref. EPDM | DN | PN | € | | |
|----|-----------------|----|----|--------|----------|----------|
| | | | | EPDM | FKM | PTFE |
| 20 | DKOC020E | 15 | 10 | 240,90 | 366,81 | 366,81 |
| 25 | DKOC025E | 20 | 10 | 262,58 | 395,96 | 395,96 |
| 32 | DKOC032E | 25 | 10 | 293,19 | 420,96 | 420,96 |
| 40 | DKOC040E | 32 | 10 | 362,95 | 556,54 | 556,54 |
| 50 | DKOC050E | 40 | 10 | 431,81 | 623,51 | 623,51 |
| 63 | DKOC063E | 50 | 10 | 543,27 | 860,90 | 860,90 |
| 75 | DKOC075E | 65 | 10 | 706,27 | 1.119,18 | 1.119,18 |

Válvula de membrana
© DIALOCK .
Con bridas DIN.

Código en FKM termina en "F"
en lugar de "E"
Código en PTFE termina en "P"
en lugar de "E"



VMDC

| d | Ref. EPDM | DN | € | | |
|-----|-----------------|-----|----------|----------|----------|
| | | | EPDM | FKM | PTFE |
| 90 | VMDC090E | 80 | 906,07 | 1.616,69 | 1.616,69 |
| 110 | VMDC110E | 100 | 1.282,02 | 2.518,97 | 2.518,97 |

Válvula de membrana
M-M encolar.

Código en FKM termina en "F"
en lugar de "E"
Código en PTFE termina en "P"
en lugar de "E"



VMOC

| d | Ref. EPDM | DN | € | | |
|-----|-----------------|-----|----------|----------|----------|
| | | | EPDM | FKM | PTFE |
| 90 | VMOC090E | 80 | 1.210,30 | 1.920,95 | 1.920,95 |
| 110 | VMOC110E | 100 | 1.638,68 | 2.875,66 | 2.875,66 |

Válvula de membrana
Con bridas DIN. Bajo pedido
con bridas ANSI 150 lbs
al mismo precio

Código en FKM termina en "F"
en lugar de "E"
Código en PTFE termina en "P"
en lugar de "E"



DKUIC

| d | Ref. EPDM | DN | PN | € | | |
|----|------------------|----|----|--------|--------|--------|
| | | | | EPDM | FKM | PTFE |
| 20 | DKUIC020E | 15 | 10 | 159,80 | 285,77 | 285,77 |
| 25 | DKUIC025E | 20 | 10 | 178,60 | 312,09 | 312,09 |
| 32 | DKUIC032E | 25 | 10 | 206,85 | 334,65 | 334,65 |
| 40 | DKUIC040E | 32 | 10 | 255,63 | 449,29 | 449,29 |
| 50 | DKUIC050E | 40 | 10 | 319,69 | 511,32 | 511,32 |
| 63 | DKUIC063E | 50 | 10 | 394,83 | 712,48 | 712,48 |

Válvula de membrana
DIALOCK®.
Con enlaces H-H para encolar.

Código en FKM termina en "F"
en lugar de "E"
Código en PTFE termina en "P"
en lugar de "E"



DKUFC

| Rh | Ref. EPDM | DN | PN | € EPDM | € FKM | € PTFE |
|-----|-----------|----|----|--------|--------|--------|
| ½" | DKUFC012E | 15 | 10 | 168,15 | 301,84 | 301,84 |
| ¾" | DKUFC034E | 20 | 10 | 193,69 | 330,58 | 330,58 |
| 1" | DKUFC100E | 25 | 10 | 221,07 | 346,70 | 346,70 |
| 1¼" | DKUFC114E | 32 | 10 | 302,15 | 496,20 | 496,20 |
| 1½" | DKUFC112E | 40 | 10 | 369,39 | 558,93 | 558,93 |
| 2" | DKUFC200E | 50 | 10 | 442,18 | 761,17 | 761,17 |

Válvula de membrana
DIALOCK®.
Con enlaces H-H para roscar.

Código en FKM termina en "F"
en lugar de "E"
Código en PTFE termina en "P"
en lugar de "E"



DKOAC

| d | Ref. EPDM | DN | PN | € EPDM | € FKM | € PTFE |
|-----|-----------|----|----|--------|----------|----------|
| ½" | DKOAC012E | 15 | 10 | 240,90 | 366,81 | 366,81 |
| ¾" | DKOAC034E | 20 | 10 | 262,58 | 395,96 | 395,96 |
| 1" | DKOAC100E | 25 | 10 | 293,19 | 420,96 | 420,96 |
| 1¼" | DKOAC114E | 32 | 10 | 362,95 | 556,54 | 556,54 |
| 1½" | DKOAC112E | 40 | 10 | 431,81 | 623,51 | 623,51 |
| 2" | DKOAC200E | 50 | 10 | 543,27 | 860,90 | 860,90 |
| 2½" | DKOAC212E | 65 | 10 | 706,27 | 1.119,18 | 1.119,18 |

Válvula de membrana
DIALOCK®.
Con bridas ANSI 150 lbs.

Código en FKM termina en "F"
en lugar de "E"
Código en PTFE termina en "P"
en lugar de "E"



RVUIC

| d | Ref. EPDM | DN | PN | € EPDM | € FKM |
|----|-----------|----|----|--------|--------|
| 20 | RVUIC020E | 15 | 16 | 127,98 | 147,19 |
| 25 | RVUIC025E | 20 | 16 | 138,23 | 162,05 |
| 32 | RVUIC032E | 25 | 16 | 181,83 | 209,40 |
| 40 | RVUIC040E | 32 | 16 | 207,99 | 259,41 |
| 50 | RVUIC050E | 40 | 16 | 263,40 | 305,99 |
| 63 | RVUIC063E | 50 | 16 | 343,61 | 385,56 |

Filtro inclinado.
Juntas en EPDM o FKM.
H-H con enlaces para encolar.

Código en FKM termina en "F"
en lugar de "E"



CMDC

M-M encolar

CMUIC

H-H enlaces encolar

| d | Ref. EPDM | DN | € EPDM | € FKM | € PTFE |
|----|-----------|----|--------|--------|--------|
| 20 | CMDC020E | 15 | 195,55 | 272,59 | 272,59 |
| 20 | CMUIC020E | 15 | 225,60 | 289,53 | 289,53 |

Válvula de membrana
compacta

Código en FKM termina en "F"
en lugar de "E"
Código en PTFE termina en "P"
en lugar de "E"



SETFLOC

| d DIN | d ANSI | Ref. DIN | € DIN 2501 | € ANSI |
|-------|--------|------------|------------|--------|
| 20 | ½" | SETFLOC020 | 61,13 | 61,13 |
| 25 | ¾" | SETFLOC025 | 70,04 | 70,04 |
| 32 | 1" | SETFLOC032 | 83,36 | 83,36 |
| 40 | 1¼" | SETFLOC040 | 104,80 | 104,80 |
| 50 | 1½" | SETFLOC050 | 113,04 | 113,04 |
| 63 | 2" | SETFLOC063 | 143,58 | 143,58 |
| 75 | 2½" | SETFLOC075 | 199,72 | |
| 90 | 3" | SETFLOC090 | 293,63 | |
| 110 | 4" | SETFLOC110 | 368,53 | |

Set embrizado.
Compuesto por 1 brida, 1 anillo fijación y 1 tuerca.
Para Válvulas VKD / TKD / RVU.

d. 75-90-110,
es el mismo artículo
para DIN y ANSI



INDUSTRIA

Sistema C-PVC

Válvulas anti-retorno con muelle



SSEIC

| d | Ref. EPDM | DN | PN | Pack | U/ | € EPDM | € FKM |
|-----|-----------|-----|----|------|----|-----------|----------|
| 16 | SSEIC016E | 10 | 16 | 2 | 30 | 96,03 | 98,55 |
| 20 | SSEIC020E | 15 | 16 | 2 | 30 | 96,03 | 98,55 |
| 25 | SSEIC025E | 20 | 16 | 2 | 30 | 103,93 | 104,28 |
| 32 | SSEIC032E | 25 | 16 | 2 | 20 | 125,15 | 127,26 |
| 40 | SSEIC040E | 32 | 16 | 2 | 14 | 142,96 | 154,48 |
| 50 | SSEIC050E | 40 | 16 | 2 | 6 | 194,65 | 206,85 |
| 63 | SSEIC063E | 50 | 16 | 2 | 6 | 234,41 | 241,41 |
| 75 | SSEIC075E | 65 | 16 | - | 1 | 650,32 | 682,35 |
| 90 | SSEIC090E | 80 | 16 | - | 1 | 840,15 | 876,82 |
| 110 | SSEIC110E | 100 | 16 | - | 1 | 1.577,27 | 1.654,80 |

Válvula de retención
con muelle en INOX 316.

Código en FKM termina en "F"
en lugar de "E"

Juntas en EPDM o FKM. H-H encolar.



SSEAC

| d | Ref. EPDM | DN | PN | Pack | U/ | € EPDM | € FKM |
|--------|-----------|----|----|------|----|-----------|----------|
| 1/2" | SSEAC012E | 10 | 16 | 2 | 30 | 96,12 | 98,60 |
| 3/4" | SSEAC034E | 15 | 16 | 2 | 30 | 104,01 | 106,44 |
| 1" | SSEAC100E | 20 | 16 | 2 | 30 | 125,25 | 127,35 |
| 1 1/4" | SSEAC114E | 25 | 16 | 2 | 20 | 143,09 | 154,58 |
| 1 1/2" | SSEAC112E | 32 | 16 | 2 | 14 | 194,78 | 207,00 |
| 2" | SSEAC200E | 40 | 16 | 2 | 6 | 234,57 | 241,58 |
| 2 1/2" | SSEAC212E | 50 | 16 | 2 | 6 | 650,80 | 682,85 |
| 3" | SSEAC300E | 65 | 16 | - | 1 | 840,77 | 877,46 |
| 4" | SSEAC400E | 80 | 16 | - | 1 | 1.578,43 | 1.656,01 |

Válvula de retención
con muelle en INOX 316.
H-H encolar serie ASTM.

Código en FKM termina en "F"
en lugar de "E"

Juntas en EPDM o FKM. H-H encolar.



SSEIC

| d | Ref. EPDM | DN | PN | Pack | U/ | € EPDM | € FKM |
|----|------------|----|----|------|----|-----------|-----------|
| 16 | SSEIC016EH | 10 | 16 | 2 | 30 | Consultar | Consultar |
| 20 | SSEIC020EH | 15 | 16 | 2 | 30 | Consultar | Consultar |
| 25 | SSEIC025EH | 20 | 16 | 2 | 30 | Consultar | Consultar |
| 32 | SSEIC032EH | 25 | 16 | 2 | 20 | Consultar | Consultar |

Válvula de retención
con muelle en HASTELLOY

Código en FKM termina en "F"
en lugar de "E"

Juntas en EPDM o FKM. H-H encolar.



SSEAC

| d | Ref. EPDM | DN | PN | Pack | U/ | € EPDM | € FKM |
|------|------------|----|----|------|----|-----------|-----------|
| 1/2" | SSEAC012EH | 15 | 16 | 2 | 30 | Consultar | Consultar |
| 3/4" | SSEAC034EH | 20 | 16 | 2 | 30 | Consultar | Consultar |
| 1" | SSEAC100EH | 25 | 16 | 2 | 30 | Consultar | Consultar |

Válvula de retención
con muelle en HASTELLOY
H-H encolar serie ASTM.

Código en FKM termina en "F"
en lugar de "E"

Juntas en EPDM o FKM. H-H encolar serie ASTM.



SSEIC

| d | Ref. EPDM | DN | PN | Pack | U/ | € EPDM | € FKM |
|-----|-------------|-----|----|------|----|-----------|-----------|
| 40 | SSEIC040EOP | 32 | 16 | 2 | 2 | Consultar | Consultar |
| 50 | SSEIC050EOP | 40 | 16 | 2 | 2 | Consultar | Consultar |
| 63 | SSEIC063EOP | 50 | 16 | 2 | 2 | Consultar | Consultar |
| 75 | SSEIC075EOP | 65 | 16 | - | 1 | Consultar | Consultar |
| 90 | SSEIC090EOP | 80 | 16 | - | 1 | Consultar | Consultar |
| 110 | SSEIC110EOP | 100 | 16 | - | 1 | Consultar | Consultar |

Válvula de retención con muelle
en INOX recubierto PTFE.

Código en FKM termina en "F"
en lugar de "E"

Juntas en EPDM o FKM. H-H encolar.



SSEAC

| d | Ref. EPDM | DN | PN | Pack | U/ | € EPDM | € FKM |
|--------|-------------|-----|----|------|----|-----------|-----------|
| 1 1/4" | SSEAC114EOP | 32 | 16 | 2 | 2 | Consultar | Consultar |
| 1 1/2" | SSEAC112EOP | 40 | 16 | 2 | 2 | Consultar | Consultar |
| 2" | SSEAC200EOP | 50 | 16 | 2 | 2 | Consultar | Consultar |
| 2 1/2" | SSEAC212EOP | 65 | 16 | - | 1 | Consultar | Consultar |
| 3" | SSEAC300EOP | 80 | 16 | - | 1 | Consultar | Consultar |
| 4" | SSEAC400EOP | 100 | 16 | - | 1 | Consultar | Consultar |

Válvula de retención con muelle
en INOX recubierto PTFE.

Código en FKM termina en "F"
en lugar de "E"

Juntas en EPDM o FKM. H-H encolar serie ASTM.



INDUSTRIA

Sistema C-PVC

Válvulas de bola actuadas



VKDIC/CE

Encolar



ACTUACIÓN ELÉCTRICA

ACTUACIÓN ELÉCTRICA CON BLOQUE DE SEGURIDAD

| d | 24-240 V AC/DC | | 24-240 V AC/DC | | 24-240 V AC/DC | | 24-240 V AC/DC | |
|-----|----------------|----------|----------------|----------|----------------|----------|----------------|----------|
| | Ref. | € | Ref. | € | Ref. | € | Ref. | € |
| | | EPDM | | FKM | | EPDM | | FKM |
| 16 | VKCE016E2D | 683,51 | VKCE016F2D | 713,22 | VKCE016E2BD | 1.238,19 | VKCE016F2BD | 1.267,91 |
| 20 | VKCE020E2D | 683,51 | VKCE020F2D | 713,22 | VKCE020E2BD | 1.238,19 | VKCE020F2BD | 1.267,91 |
| 25 | VKCE025E2D | 694,82 | VKCE025F2D | 726,44 | VKCE025E2BD | 1.249,47 | VKCE025F2BD | 1.281,09 |
| 32 | VKCE032E2D | 716,14 | VKCE032F2D | 744,02 | VKCE032E2BD | 1.270,79 | VKCE032F2BD | 1.298,71 |
| 40 | VKCE040E2D | 744,59 | VKCE040F2D | 771,57 | VKCE040E2BD | 1.299,27 | VKCE040F2BD | 1.326,26 |
| 50 | VKCE050E2D | 776,65 | VKCE050F2D | 818,03 | VKCE050E2BD | 1.331,28 | VKCE050F2BD | 1.372,71 |
| 63 | VKCE063E2D | 828,33 | VKCE063F2D | 887,48 | VKCE063E2BD | 1.383,01 | VKCE063F2BD | 1.442,13 |
| 75 | VKCE075E2D | 1.472,11 | VKCE075F2D | 1.670,33 | VKCE075E2BD | 2.026,78 | VKCE075F2BD | 2.224,99 |
| 90 | VKCE090E2D | 1.682,87 | VKCE090F2D | 1.917,29 | VKCE090E2BD | 2.237,52 | VKCE090F2BD | 2.471,98 |
| 110 | VKCE110E2D | 2.243,60 | VKCE110F2D | 2.478,06 | VKCE110E2BD | 2.798,28 | VKCE110F2BD | 3.032,73 |

Válvula de bola motorizada

en C-PVC 2 vías DUAL BLOCK®.

Actuación eléctrica

Disponemos de otras conexiones bajo pedido: bridas, encolar macho y roscar (GAS,NPT)

Bajo pedido podemos suministrar otros actuadores: VALPES, BELIMO... Bajo pedido también disponibles en 12V AC/DC

VKDIC/CP

Encolar



ACTUACIÓN NEUMÁTICA ALUMINIO

ACTUACIÓN NEUMÁTICA ALUMINIO CON ELECTROVÁLVULA, FINALES DE CARRERA (ELECTROMECÁNICOS) Y REGULADORES DE ESCAPE

| d | DOBLE EFECTO | | SIMPLE EFECTO | | DOBLE EFECTO | | SIMPLE EFECTO | |
|-----|--------------|----------|---------------|----------|--------------|----------|---------------|----------|
| | Ref. | € | Ref. | € | Ref. | € | Ref. | € |
| | | EPDM | | FKM | | EPDM | | FKM |
| 16 | VKCP016EDED | 346,13 | VKCP016ESED | 376,86 | VKCP016EDEFD | 546,78 | VKCP016ESEFD | 588,11 |
| 20 | VKCP020EDED | 346,13 | VKCP020ESED | 376,86 | VKCP020EDEFD | 546,78 | VKCP020ESEFD | 588,11 |
| 25 | VKCP025EDED | 357,41 | VKCP025ESED | 388,13 | VKCP025EDEFD | 558,05 | VKCP025ESEFD | 599,36 |
| 32 | VKCP032EDED | 378,76 | VKCP032ESED | 409,43 | VKCP032EDEFD | 579,38 | VKCP032ESEFD | 620,68 |
| 40 | VKCP040EDED | 407,19 | VKCP040ESED | 437,90 | VKCP040EDEFD | 607,83 | VKCP040ESEFD | 649,14 |
| 50 | VKCP050EDED | 439,22 | VKCP050ESED | 529,57 | VKCP050EDEFD | 639,87 | VKCP050ESEFD | 740,81 |
| 63 | VKCP063EDED | 490,98 | VKCP063ESED | 660,21 | VKCP063EDEFD | 691,59 | VKCP063ESEFD | 871,43 |
| 75 | VKCP075EDED | 973,40 | VKCP075ESED | 1.093,14 | VKCP075EDEFD | 1.174,02 | VKCP075ESEFD | 1.304,37 |
| 90 | VKCP090EDED | 1.184,17 | VKCP090ESED | 1.303,91 | VKCP090EDEFD | 1.384,78 | VKCP090ESEFD | 1.515,13 |
| 110 | VKCP110EDED | 1.394,24 | VKCP110ESED | 1.818,03 | VKCP110EDEFD | 1.594,88 | VKCP110ESEFD | 2.029,23 |

| | | | | | | | | |
|-----|-------------|----------|-------------|----------|--------------|----------|--------------|----------|
| 16 | VKCP016FDED | 375,88 | VKCP016FSED | 406,59 | VKCP016FDEFD | 576,49 | VKCP016FSEFD | 617,79 |
| 20 | VKCP020FDED | 375,88 | VKCP020FSED | 406,59 | VKCP020FDEFD | 576,49 | VKCP020FSEFD | 617,79 |
| 25 | VKCP025FDED | 389,06 | VKCP025FSED | 419,76 | VKCP025FDEFD | 589,65 | VKCP025FSEFD | 630,98 |
| 32 | VKCP032FDED | 406,62 | VKCP032FSED | 437,34 | VKCP032FDEFD | 607,27 | VKCP032FSEFD | 648,57 |
| 40 | VKCP040FDED | 434,20 | VKCP040FSED | 464,89 | VKCP040FDEFD | 634,84 | VKCP040FSEFD | 676,12 |
| 50 | VKCP050FDED | 480,65 | VKCP050FSED | 571,01 | VKCP050FDEFD | 681,27 | VKCP050FSEFD | 782,26 |
| 63 | VKCP063FDED | 550,10 | VKCP063FSED | 719,33 | VKCP063FDEFD | 750,72 | VKCP063FSEFD | 930,55 |
| 75 | VKCP075FDED | 1.171,60 | VKCP075FSED | 1.291,34 | VKCP075FDEFD | 1.372,25 | VKCP075FSEFD | 1.502,59 |
| 90 | VKCP090FDED | 1.418,60 | VKCP090FSED | 1.538,34 | VKCP090FDEFD | 1.619,24 | VKCP090FSEFD | 1.749,56 |
| 110 | VKCP110FDED | 1.628,69 | VKCP110FSED | 2.052,46 | VKCP110FDEFD | 1.829,31 | VKCP110FSEFD | 2.263,66 |

Válvula de bola motorizada

en C-PVC 2 vías DUAL BLOCK®. Actuación eléctrica.

Disponemos de otras conexiones bajo pedido: bridas, encolar macho y roscar (GAS,NPT)

Las válvulas neumáticas se configuran NC (normalmente cerrada) de serie.

La configuración NA (normalmente abierta) se debe especificar en el pedido

VKDIC/CP

Encolar



ACTUACIÓN NEUMÁTICA POLIAMIDA

ACTUACIÓN NEUMÁTICA POLIAMIDA CON ELECTROVÁLVULA, FINALES DE CARRERA (ELECTROMECAÑICOS) Y REGULADORES DE ESCAPE

| d | DOBLE EFECTO | | SIMPLE EFECTO | | DOBLE EFECTO | | SIMPLE EFECTO | |
|-----|--------------|----------|---------------|----------|--------------|----------|---------------|----------|
| | Ref. | € EPDM | Ref | € FKM | Ref. | € EPDM | Ref. | € FKM |
| 16 | VKCP016EDEP | 364,86 | VKCP016ESEP | 388,00 | VKCP016EDEF | 627,30 | VKCP016ESEFP | 650,45 |
| 20 | VKCP020EDEP | 364,86 | VKCP020ESEP | 388,00 | VKCP020EDEF | 627,30 | VKCP020ESEFP | 650,45 |
| 25 | VKCP025EDEP | 376,16 | VKCP025ESEP | 399,31 | VKCP025EDEF | 638,60 | VKCP025ESEFP | 661,75 |
| 32 | VKCP032EDEP | 397,46 | VKCP032ESEP | 524,73 | VKCP032EDEF | 659,90 | VKCP032ESEFP | 787,16 |
| 40 | VKCP040EDEP | 425,94 | VKCP040ESEP | 553,16 | VKCP040EDEF | 688,38 | VKCP040ESEFP | 815,61 |
| 50 | VKCP050EDEP | 457,97 | VKCP050ESEP | 706,66 | VKCP050EDEF | 720,43 | VKCP050ESEFP | 969,08 |
| 63 | VKCP063EDEP | 713,77 | VKCP063ESEP | 780,28 | VKCP063EDEF | 976,21 | VKCP063ESEFP | 1.042,72 |
| 75 | VKCP075EDEP | 1.102,44 | VKCP075ESEP | 1.351,57 | VKCP075EDEF | 1.364,85 | VKCP075ESEFP | 1.614,01 |
| 90 | VKCP090EDEP | 1.313,20 | VKCP090ESEP | 1.562,33 | VKCP090EDEF | 1.575,62 | VKCP090ESEFP | 1.824,80 |
| 110 | VKCP110EDEP | 1.489,84 | VKCP110ESEP | 1.760,25 | VKCP110EDEF | 1.752,29 | VKCP110ESEFP | 2.022,71 |
| 16 | VKCP016FDEP | 394,62 | VKCP016FSEP | 417,77 | VKCP016FDEF | 657,04 | VKCP016FSEFD | 617,79 |
| 20 | VKCP020FDEP | 394,62 | VKCP020FSEP | 417,77 | VKCP020FDEF | 657,04 | VKCP020FSEFD | 617,79 |
| 25 | VKCP025FDEP | 407,81 | VKCP025FSEP | 430,93 | VKCP025FDEF | 670,22 | VKCP025FSEFD | 630,98 |
| 32 | VKCP032FDEP | 425,37 | VKCP032FSEP | 552,63 | VKCP032FDEF | 687,81 | VKCP032FSEFD | 648,57 |
| 40 | VKCP040FDEP | 452,92 | VKCP040FSEP | 580,18 | VKCP040FDEF | 715,37 | VKCP040FSEFD | 676,12 |
| 50 | VKCP050FDEP | 499,37 | VKCP050FSEP | 748,09 | VKCP050FDEF | 761,82 | VKCP050FSEFD | 782,26 |
| 63 | VKCP063FDEP | 772,89 | VKCP063FSEP | 839,40 | VKCP063FDEF | 1.035,34 | VKCP063FSEFD | 930,55 |
| 75 | VKCP075FDEP | 1.300,63 | VKCP075FSEP | 1.549,77 | VKCP075FDEF | 1.563,08 | VKCP075FSEFD | 1.502,59 |
| 90 | VKCP090FDEP | 1.547,61 | VKCP090FSEP | 1.796,76 | VKCP090FDEF | 1.810,05 | VKCP090FSEFD | 1.749,56 |
| 110 | VKCP110FDEP | 1.724,27 | VKCP110FSEP | 1.994,68 | VKCP110FDEF | 1.986,72 | VKCP110FSEFD | 2.263,66 |

Válvula de bola motorizada en C-PVC 2 vías DUAL BLOCK®. Actuación eléctrica.

Disponemos de otras conexiones bajo pedido: bridas, encolar macho y roscar (GAS, NPT)
 Las válvulas neumáticas se configuran NC (normalmente cerrada) de serie.
 La configuración NA (normalmente abierta) se debe especificar en el pedido



INDUSTRIA

Sistema C-PVC

Válvulas de 3 vías actuadas



LKDIC/CE

Encolar



ACTUACIÓN ELÉCTRICA

ACTUACIÓN ELÉCTRICA CON BLOQUE DE SEGURIDAD

| d | 24-240 V AC/DC | | 24-240 V AC/DC | | 24-240 V AC/DC | | 24-240 V AC/DC | |
|----|----------------|----------|----------------|----------|----------------|----------|----------------|----------|
| | Ref. | € | Ref. | € | Ref. | € | Ref. | € |
| | | EPDM | | FKM | | EPDM | | FKM |
| 16 | LKCE016E2D | 801,24 | LKCE016F2D | 816,79 | LKCE016E2BD | 1.355,92 | LKCE016F2BD | 1.371,45 |
| 20 | LKCE020E2D | 801,24 | LKCE020F2D | 816,79 | LKCE020E2BD | 1.355,92 | LKCE020F2BD | 1.371,45 |
| 25 | LKCE025E2D | 822,51 | LKCE025F2D | 843,24 | LKCE025E2BD | 1.377,19 | LKCE025F2BD | 1.397,92 |
| 32 | LKCE032E2D | 868,91 | LKCE032F2D | 894,66 | LKCE032E2BD | 1.423,56 | LKCE032F2BD | 1.449,29 |
| 40 | LKCE040E2D | 943,15 | LKCE040F2D | 980,35 | LKCE040E2BD | 1.497,81 | LKCE040F2BD | 1.535,01 |
| 50 | LKCE050E2D | 982,21 | LKCE050F2D | 1.044,68 | LKCE050E2BD | 1.536,89 | LKCE050F2BD | 1.599,33 |
| 63 | LKCE063E2D | 1.091,39 | LKCE063F2D | 1.170,08 | LKCE063E2BD | 1.646,02 | LKCE063F2BD | 1.724,74 |

Válvula de bola motorizada en C-PVC 3 vías DUAL BLOCK®. Actuación eléctrica

Estándar paso en L, paso en T opcional, al mismo precio. Disponemos de otras conexiones bajo pedido: bridas, encolar macho y roscar (GAS, NPT) Bajo pedido podemos suministrar otros actuadores: VALPES, BELIMO...

Bajo pedido también disponibles en 12V AC/DC

LKDIC/CP

Encolar



ACTUACIÓN NEUMÁTICA ALUMINIO

ACTUACIÓN NEUMÁTICA ALUMINIO CON ELECTROVÁLVULA, FINALES DE CARRERA (ELECTROMECÁNICOS) Y REGULADORES DE ESCAPE

| d | DOBLE EFECTO | | SIMPLE EFECTO | | DOBLE EFECTO | | SIMPLE EFECTO | |
|----|--------------|--------|---------------|----------|--------------|----------|---------------|----------|
| | Ref. | € | Ref. | € | Ref. | € | Ref. | € |
| | | EPDM | | FKM | | EPDM | | FKM |
| 16 | LKCP016EDED | 463,86 | LKCP016ESED | 494,59 | LKCP016EDEFD | 664,50 | LKCP016ESEFD | 705,79 |
| 20 | LKCP020EDED | 463,86 | LKCP020ESED | 494,59 | LKCP020EDEFD | 664,50 | LKCP020ESEFD | 705,79 |
| 25 | LKCP025EDED | 485,13 | LKCP025ESED | 515,85 | LKCP025EDEFD | 685,77 | LKCP025ESEFD | 727,08 |
| 32 | LKCP032EDED | 531,51 | LKCP032ESED | 562,26 | LKCP032EDEFD | 732,15 | LKCP032ESEFD | 773,46 |
| 40 | LKCP040EDED | 605,79 | LKCP040ESED | 696,13 | LKCP040EDEFD | 806,42 | LKCP040ESEFD | 907,33 |
| 50 | LKCP050EDED | 680,62 | LKCP050ESED | 814,09 | LKCP050EDEFD | 881,22 | LKCP050ESEFD | 1.025,29 |
| 63 | LKCP063EDED | 789,73 | LKCP063ESED | 923,19 | LKCP063EDEFD | 990,35 | LKCP063ESEFD | 1.134,44 |
| 16 | LKCP016FDED | 479,39 | LKCP016FSED | 510,09 | LKCP016FDEFD | 680,01 | LKCP016FSEFD | 721,34 |
| 20 | LKCP020FDED | 479,39 | LKCP020FSED | 510,09 | LKCP020FDEFD | 680,01 | LKCP020FSEFD | 721,34 |
| 25 | LKCP025FDED | 505,86 | LKCP025FSED | 536,58 | LKCP025FDEFD | 706,51 | LKCP025FSEFD | 747,81 |
| 32 | LKCP032FDED | 557,26 | LKCP032FSED | 587,95 | LKCP032FDEFD | 757,87 | LKCP032FSEFD | 799,21 |
| 40 | LKCP040FDED | 642,96 | LKCP040FSED | 733,31 | LKCP040FDEFD | 843,57 | LKCP040FSEFD | 944,54 |
| 50 | LKCP050FDED | 743,04 | LKCP050FSED | 876,53 | LKCP050FDEFD | 943,69 | LKCP050FSEFD | 1.087,78 |
| 63 | LKCP063FDED | 868,42 | LKCP063FSED | 1.001,96 | LKCP063FDEFD | 1.069,07 | LKCP063FSEFD | 1.213,16 |

Válvula de bola motorizada en C-PVC 3 vías DUAL BLOCK®. Actuación neumática

Estándar paso en L, paso en T opcional, al mismo precio. Disponemos de otras conexiones bajo pedido: bridas, encolar macho y roscar (GAS, NPT) Las válvulas neumáticas se configuran NC (normalmente cerrada) de serie. La configuración NA (normalmente abierta) se debe especificar en el pedido

LKDIC/CP

Encolar



ACTUACIÓN NEUMÁTICA POLIAMIDA

ACTUACIÓN NEUMÁTICA POLIAMIDA CON ELECTROVÁLVULA, FINALES DE CARRERA (ELECTROMECAÑICOS) Y REGULADORES DE ESCAPE

| d | DOBLE EFECTO | | SIMPLE EFECTO | | DOBLE EFECTO | | SIMPLE EFECTO | |
|----|--------------|----------|---------------|----------|--------------|----------|---------------|----------|
| | Ref. | € EPDM | Ref. | € FKM | Ref. | € EPDM | Ref. | € FKM |
| 16 | LKCP016EDEP | 522,03 | LKCP016ESEP | 545,16 | LKCP016EDEFP | 784,48 | LKCP016ESEFP | 807,60 |
| 20 | LKCP020EDEP | 522,03 | LKCP020ESEP | 545,16 | LKCP020EDEFP | 784,48 | LKCP020ESEFP | 807,60 |
| 25 | LKCP025EDEP | 588,47 | LKCP025ESEP | 611,61 | LKCP025EDEFP | 850,91 | LKCP025ESEFP | 874,06 |
| 32 | LKCP032EDEP | 634,89 | LKCP032ESEP | 762,13 | LKCP032EDEFP | 897,32 | LKCP032ESEFP | 1.024,57 |
| 40 | LKCP040EDEP | 724,04 | LKCP040ESEP | 972,71 | LKCP040EDEFP | 986,46 | LKCP040ESEFP | 1.235,16 |
| 50 | LKCP050EDEP | 856,08 | LKCP050ESEP | 1.009,33 | LKCP050EDEFP | 1.118,51 | LKCP050ESEFP | 1.271,77 |
| 63 | LKCP063EDEP | 1.041,36 | LKCP063ESEP | 1.107,87 | LKCP063EDEFP | 1.303,77 | LKCP063ESEFP | 1.370,31 |

| d | DOBLE EFECTO | | SIMPLE EFECTO | | DOBLE EFECTO | | SIMPLE EFECTO | |
|----|--------------|----------|---------------|----------|--------------|----------|---------------|----------|
| | Ref. | € EPDM | Ref. | € FKM | Ref. | € EPDM | Ref. | € FKM |
| 16 | LKCP016FDEP | 537,54 | LKCP016FSEP | 560,68 | LKCP016FDEFP | 799,98 | LKCP016FSEFP | 823,10 |
| 20 | LKCP020FDEP | 537,54 | LKCP020FSEP | 560,68 | LKCP020FDEFP | 799,98 | LKCP020FSEFP | 823,10 |
| 25 | LKCP025FDEP | 609,19 | LKCP025FSEP | 632,37 | LKCP025FDEFP | 871,67 | LKCP025FSEFP | 894,81 |
| 32 | LKCP032FDEP | 660,59 | LKCP032FSEP | 787,85 | LKCP032FDEFP | 923,03 | LKCP032FSEFP | 1.050,29 |
| 40 | LKCP040FDEP | 761,22 | LKCP040FSEP | 1.009,92 | LKCP040FDEFP | 1.023,64 | LKCP040FSEFP | 1.272,36 |
| 50 | LKCP050FDEP | 918,50 | LKCP050FSEP | 1.071,77 | LKCP050FDEFP | 1.180,98 | LKCP050FSEFP | 1.334,21 |
| 63 | LKCP063FDEP | 1.120,07 | LKCP063FSEP | 1.186,59 | LKCP063FDEFP | 1.382,52 | LKCP063FSEFP | 1.449,00 |

Válvula de bola motorizada en C-PVC 3 vías DUAL BLOCK®. Actuación neumática.

Estándar paso en L, paso en T opcional, al mismo precio. Disponemos de otras conexiones bajo pedido: bridas, encolar macho y roscar (GAS, NPT). Las válvulas neumáticas se configuran NC (normalmente cerrada) de serie. La configuración NA (normalmente abierta) se debe especificar en el pedido.

FKOC/CE

ACTUACIÓN ELÉCTRICA

ACTUACIÓN ELÉCTRICA CON BLOQUE DE SEGURIDAD

| d | 24-240 V AC/DC | | 24-240 V AC/DC | | 24-240 V AC/DC | | 24-240 V AC/DC | |
|-----------|----------------|----------|----------------|----------|----------------|----------|----------------|----------|
| | Ref. | € EPDM | Ref. | € FKM | Ref. | € EPDM | Ref. | € FKM |
| 50 | FKCE050E2D | 889,41 | FKCE050F2D | 1.053,62 | FKCE050E2BD | 1.444,11 | FKCE050F2BD | 1.608,29 |
| 63 | FKCE063E2D | 909,47 | FKCE063F2D | 1.083,23 | FKCE063E2BD | 1.464,15 | FKCE063F2BD | 1.637,91 |
| 75 | FKCE075E2D | 1.209,15 | FKCE075F2D | 1.402,32 | FKCE075E2BD | 1.763,82 | FKCE075F2BD | 1.957,03 |
| 90 | FKCE090E2D | 1.244,06 | FKCE090F2D | 1.445,81 | FKCE090E2BD | 1.798,72 | FKCE090F2BD | 2.000,47 |
| 110 | FKCE110E2D | 1.281,73 | FKCE110F2D | 1.490,82 | FKCE110E2BD | 1.836,39 | FKCE110F2BD | 2.045,51 |
| 125 | FKCE140E2D | 1.803,02 | FKCE140F2D | 2.087,58 | FKCE140E2BD | 2.357,67 | FKCE140F2BD | 2.642,24 |
| 140 | FKCE140E2D | 1.803,02 | FKCE140F2D | 2.087,58 | FKCE140E2BD | 2.357,67 | FKCE140F2BD | 2.642,24 |
| 160 | FKCE160E2D | 2.110,24 | FKCE160F2D | 2.393,44 | FKCE160E2BD | 2.759,35 | FKCE160F2BD | 3.042,50 |
| 200 - 225 | FKCE225E2D | 2.458,87 | FKCE225F2D | 2.827,61 | FKCE225E2BD | 3.107,95 | FKCE225F2BD | 3.476,71 |
| 250 | FKCE280E2D | 4.498,22 | FKCE280F2D | 6.191,48 | FKCE280E2BD | 5.147,32 | FKCE280F2BD | 6.840,57 |
| 280 | FKCE280E2D | 4.498,22 | FKCE280F2D | 6.191,48 | FKCE280E2BD | 5.147,32 | FKCE280F2BD | 6.840,57 |
| 315 | FKCE315E2D | 4.756,78 | FKCE315F2D | 6.603,95 | FKCE315E2BD | 5.405,85 | FKCE315F2BD | 7.253,05 |

Válvula de mariposa industrial motorizada cuerpo en PPGR y disco en C-PVC. Actuación eléctrica.

Bajo pedido podemos suministrar otros actuadores: VALPES, BELIMO...
 Bajo pedido también disponibles en 12V AC/DC



FKOC/CP

ACTUACIÓN NEUMÁTICA ALUMINIO

ACTUACIÓN NEUMÁTICA ALUMINIO CON ELECTROVÁLVULA, FINALES DE CARRERA (ELECTROMECAÑICOS) Y REGULADORES DE ESCAPE

| d | DOBLE EFECTO | | | SIMPLE EFECTO | | | DOBLE EFECTO | | DOBLE EFECTO | |
|-----------|--------------|----------|--|---------------|----------|--|--------------|----------|--------------|----------|
| | Ref. | € | | Ref. | € | | Ref. | € | Ref. | € |
| 50 | FKCP050EDED | 551,70 | | FKCP050ESED | 642,05 | | FKCP050EDEFD | 752,34 | FKCP050ESEFD | 853,25 |
| 63 | FKCP063EDED | 571,75 | | FKCP063ESED | 662,11 | | FKCP063EDEFD | 772,38 | FKCP063ESEFD | 873,32 |
| 75 | FKCP075EDED | 647,56 | | FKCP075ESED | 781,03 | | FKCP075EDEFD | 848,15 | FKCP075ESEFD | 992,25 |
| 90 | FKCP090EDED | 744,98 | | FKCP090ESED | 864,74 | | FKCP090EDEFD | 945,62 | FKCP090ESEFD | 1.075,97 |
| 110 | FKCP110EDED | 782,70 | | FKCP110ESED | 1.233,46 | | FKCP110EDEFD | 983,32 | FKCP110ESEFD | 1.444,68 |
| 125 | FKCP140EDED | 970,81 | | FKCP140ESED | 1.648,24 | | FKCP140EDEFD | 1.171,45 | FKCP140ESEFD | 1.859,44 |
| 140 | FKCP140EDED | 970,81 | | FKCP140ESED | 1.648,24 | | FKCP140EDEFD | 1.171,45 | FKCP140ESEFD | 1.859,44 |
| 160 | FKCP160EDED | 1.036,13 | | FKCP160ESED | 1.713,51 | | FKCP160EDEFD | 1.236,75 | FKCP160ESEFD | 1.924,74 |
| 200 - 225 | FKCP225EDED | 1.523,68 | | FKCP225ESED | 2.453,39 | | FKCP225EDEFD | 1.724,27 | FKCP225ESEFD | 2.664,56 |
| 250 | FKCP280EDED | 3.743,95 | | FKCP280ESED | 5.714,93 | | FKCP280EDEFD | 3.944,59 | FKCP280ESEFD | 5.926,16 |
| 280 | FKCP280EDED | 3.743,95 | | FKCP280ESED | 5.714,93 | | FKCP280EDEFD | 3.944,59 | FKCP280ESEFD | 5.926,16 |
| 315 | FKCP315EDED | 4.270,57 | | FKCP315ESED | 6.991,69 | | FKCP315EDEFD | 4.471,18 | FKCP315ESEFD | 7.202,89 |
| 50 | FKCP050FDED | 715,88 | | FKCP050FSED | 806,23 | | FKCP050FDEFD | 916,52 | FKCP050FSEFD | 1.017,46 |
| 63 | FKCP063FDED | 745,49 | | FKCP063FSED | 835,85 | | FKCP063FDEFD | 946,14 | FKCP063FSEFD | 1.047,08 |
| 75 | FKCP075FDED | 840,72 | | FKCP075FSED | 974,20 | | FKCP075FDEFD | 1.041,36 | FKCP075FSEFD | 1.185,43 |
| 90 | FKCP090FDED | 946,76 | | FKCP090FSED | 1.066,49 | | FKCP090FDEFD | 1.147,37 | FKCP090FSEFD | 1.277,72 |
| 110 | FKCP110FDED | 991,79 | | FKCP110FSED | 1.442,57 | | FKCP110FDEFD | 1.192,41 | FKCP110FSEFD | 1.653,77 |
| 125 | FKCP140FDED | 1.255,39 | | FKCP140FSED | 1.932,77 | | FKCP140FDEFD | 1.456,01 | FKCP140FSEFD | 2.144,00 |
| 140 | FKCP140FDED | 1.255,39 | | FKCP140FSED | 1.932,77 | | FKCP140FDEFD | 1.456,01 | FKCP140FSEFD | 2.144,00 |
| 160* | FKCP160FDED | 1.319,31 | | FKCP160FSED | 1.996,71 | | FKCP160FDEFD | 1.519,95 | FKCP160FSEFD | 2.207,94 |
| 200 - 225 | FKCP225FDED | 1.892,45 | | FKCP225FSED | 2.822,13 | | FKCP225FDEFD | 2.093,06 | FKCP225FSEFD | 3.033,33 |
| 250 | FKCP280FDED | 5.437,19 | | FKCP280FSED | 7.408,15 | | FKCP280FDEFD | 5.637,81 | FKCP280FSEFD | 7.619,40 |
| 280 | FKCP280FDED | 5.437,19 | | FKCP280FSED | 7.408,15 | | FKCP280FDEFD | 5.637,81 | FKCP280FSEFD | 7.619,40 |
| 315 | FKCP315FDED | 6.117,72 | | FKCP315FSED | 8.838,87 | | FKCP315FDEFD | 6.318,36 | FKCP315FSEFD | 9.050,10 |

Válvula de mariposa industrial motorizada cuerpo en PPGR y disco en C-PVC Actuación neumática.

Las válvulas neumáticas se configuran NC (normalmente cerrada) de serie. La configuración NA (normalmente abierta) se debe especificar en el pedido



FKOC/CP

ACTUACIÓN NEUMÁTICA POLIAMIDA

ACTUACIÓN NEUMÁTICA POLIAMIDA CON ELECTROVÁLVULA, FINALES DE CARRERA (ELECTROMECAÑICOS) Y REGULADORES DE ESCAPE

| d | DOBLE EFECTO | | SIMPLE EFECTO | | DOBLE EFECTO | | DOBLE EFECTO | |
|------|--------------|----------|---------------|----------|---------------|----------|--------------|----------|
| | Ref. | € | Ref. | € | Ref. | € | Ref. | € |
| 50 | FKCP050EDEP | 658,66 | FKCP050ESEP | 821,82 | FKCP050EDEFPP | 921,08 | FKCP050ESEFP | 1.084,26 |
| 63 | FKCP063EDEP | 678,70 | FKCP063ESEP | 841,87 | FKCP063EDEFPP | 941,14 | FKCP063ESEFP | 1.104,31 |
| 75 | FKCP075EDEP | 718,76 | FKCP075ESEP | 881,92 | FKCP075EDEFPP | 981,21 | FKCP075ESEFP | 1.144,36 |
| 90 | FKCP090EDEP | 849,94 | FKCP090ESEP | 916,47 | FKCP090EDEFPP | 1.112,40 | FKCP090ESEFP | 1.178,89 |
| 110 | FKCP110EDEP | 887,65 | FKCP110ESEP | 1.149,38 | FKCP110EDEFPP | 1.150,08 | FKCP110ESEFP | 1.411,82 |
| 125 | FKCP140EDEP | 1.034,48 | FKCP140ESEP | 1.596,38 | FKCP140EDEFPP | 1.296,92 | FKCP140ESEFP | 1.858,79 |
| 140 | FKCP140EDEP | 1.034,48 | FKCP140ESEP | 1.596,38 | FKCP140EDEFPP | 1.296,92 | FKCP140ESEFP | 1.858,79 |
| 160 | FKCP160EDEP | 1.283,38 | FKCP160ESEP | 1.661,68 | FKCP160EDEFPP | 1.545,82 | FKCP160ESEFP | 1.924,12 |
| 200 | FKCP225EDEP | 1.505,07 | FKCP225ESEP | 2.285,72 | FKCP225EDEFPP | 1.767,51 | FKCP225ESEFP | 2.548,15 |
| 225 | FKCP225EDEP | 1.505,07 | FKCP225ESEP | 2.285,72 | FKCP225EDEFPP | 1.767,51 | FKCP225ESEFP | 2.548,15 |
| 250* | FKCP280EDEP | 3.922,65 | FKCP280ESEP | 5.596,18 | FKCP280EDEFPP | 4.185,08 | FKCP280ESEFP | 5.858,62 |
| 280* | FKCP280EDEP | 3.922,65 | FKCP280ESEP | 5.596,18 | FKCP280EDEFPP | 4.185,08 | FKCP280ESEFP | 5.858,62 |
| 315* | FKCP315EDEP | 4.181,21 | FKCP315ESEP | 5.854,76 | FKCP315EDEFPP | 4.443,66 | FKCP315ESEFP | 6.117,15 |
| 50 | FKCP050FDEP | 822,85 | FKCP050FSEP | 986,00 | FKCP050FDEFPP | 1.085,29 | FKCP050FSEFP | 1.248,44 |
| 63 | FKCP063FDEP | 852,46 | FKCP063FSEP | 1.015,63 | FKCP063FDEFPP | 1.114,90 | FKCP063FSEFP | 1.278,05 |
| 75 | FKCP075FDEP | 911,94 | FKCP075FSEP | 1.075,09 | FKCP075FDEFPP | 1.174,35 | FKCP075FSEFP | 1.337,56 |
| 90 | FKCP090FDEP | 1.051,73 | FKCP090FSEP | 1.118,25 | FKCP090FDEFPP | 1.314,16 | FKCP090FSEFP | 1.380,66 |
| 110 | FKCP110FDEP | 1.096,74 | FKCP110FSEP | 1.358,50 | FKCP110FDEFPP | 1.359,19 | FKCP110FSEFP | 1.620,96 |
| 125 | FKCP140FDEP | 1.319,02 | FKCP140FSEP | 1.880,91 | FKCP140FDEFPP | 1.581,49 | FKCP140FSEFP | 2.143,36 |
| 140 | FKCP140FDEP | 1.319,02 | FKCP140FSEP | 1.880,91 | FKCP140FDEFPP | 1.581,49 | FKCP140FSEFP | 2.143,36 |
| 160* | FKCP160FDEP | 1.566,56 | FKCP160FSEP | 1.944,85 | FKCP160FDEFPP | 1.829,00 | FKCP160FSEFP | 2.207,27 |
| 200 | FKCP225FDEP | 1.873,83 | FKCP225FSEP | 2.654,50 | FKCP225FDEFPP | 2.136,25 | FKCP225FSEFP | 2.916,94 |
| 225 | FKCP225FDEP | 1.873,83 | FKCP225FSEP | 2.654,50 | FKCP225FDEFPP | 2.136,25 | FKCP225FSEFP | 2.916,94 |
| 250* | FKCP280FDEP | 5.615,87 | FKCP280FSEP | 7.289,41 | FKCP280FDEFPP | 5.878,29 | FKCP280FSEFP | 7.551,86 |
| 280* | FKCP280FDEP | 5.615,87 | FKCP280FSEP | 7.289,41 | FKCP280FDEFPP | 5.878,29 | FKCP280FSEFP | 7.551,86 |
| 315* | FKCP315FDEP | 6.028,36 | FKCP315FSEP | 7.701,91 | FKCP315FDEFPP | 6.290,81 | FKCP315FSEFP | 7.964,35 |

Válvula de mariposa industrial motorizada
 cuerpo en PPGR y disco en C-PVC
 Actuación neumática.

Las válvulas neumáticas se configuran NC (normalmente cerrada) de serie.
 La configuración NA (normalmente abierta) se debe especificar en el pedido
 * Actuadores de aluminio



Sistema C-PVC

Válvulas de membrana actuadas

**DK/CP NC****VM/CP NC**

| d | Modelo. | DN | Ref. EPDM | € EPDM | Ref. FKM | € FKM | Ref. PTFE | € PTFE |
|-----|------------|-----|------------|-----------|------------|----------|------------|-----------|
| 20 | DKDC/CP NC | 15 | DKDCNC020E | 396,55 | DKDCNC020F | 499,76 | DKDCNC020P | 514,67 |
| 25 | DKDC/CP NC | 20 | DKDCNC025E | 414,99 | DKDCNC025F | 519,31 | DKDCNC025P | 534,81 |
| 32 | DKDC/CP NC | 25 | DKDCNC032E | 508,44 | DKDCNC032F | 634,15 | DKDCNC032P | 669,55 |
| 40 | DKDC/CP NC | 32 | DKDCNC040E | 667,32 | DKDCNC040F | 850,76 | DKDCNC040P | 888,77 |
| 50 | DKDC/CP NC | 40 | DKDCNC050E | 756,31 | DKDCNC050F | 959,37 | DKDCNC050P | 959,37 |
| 63 | DKDC/CP NC | 50 | DKDCNC063E | 1.043,78 | DKDCNC063F | 1.370,39 | DKDCNC063P | 1.341,37 |
| 75 | DKDC/CP NC | 65 | DKDCNC075E | 1.252,48 | DKDCNC075F | 1.644,45 | DKDCNC075P | 1.609,68 |
| 90 | VMDC/CP NC | 80 | VMDCNC090E | 1.893,53 | VMDCNC090F | 2.521,83 | VMDCNC090P | 2.189,63 |
| 110 | VMDC/CP NC | 100 | VMDCNC110E | 2.298,50 | VMDCNC110F | 2.915,91 | VMDCNC110P | 2.589,30 |

Válvula neumática **NORMALMENTE CERRADA.**

M-M encolar

DK/CP NO**VM/CP NO**

| d | Modelo. | DN | Ref. EPDM | € EPDM | Ref. FKM | € FKM | Ref. PTFE | € PTFE |
|-----|------------|-----|------------|-----------|------------|----------|------------|-----------|
| 20 | DKDC/CP NO | 15 | DKDCNO020E | 357,41 | DKDCNO020F | 467,57 | DKDCNO020P | 501,10 |
| 25 | DKDC/CP NO | 20 | DKDCNO025E | 377,08 | DKDCNO025F | 488,48 | DKDCNO025P | 523,24 |
| 32 | DKDC/CP NO | 25 | DKDCNO032E | 446,02 | DKDCNO032F | 512,22 | DKDCNO032P | 560,04 |
| 40 | DKDC/CP NO | 32 | DKDCNO040E | 480,63 | DKDCNO040F | 705,99 | DKDCNO040P | 758,96 |
| 50 | DKDC/CP NO | 40 | DKDCNO050E | 560,22 | DKDCNO050F | 803,97 | DKDCNO050P | 803,97 |
| 63 | DKDC/CP NO | 50 | DKDCNO063E | 713,33 | DKDCNO063F | 1.106,25 | DKDCNO063P | 1.106,25 |
| 75 | DKDC/CP NO | 65 | DKDCNO075E | 855,98 | DKDCNO075F | 1.327,49 | DKDCNO075P | 1.327,49 |
| 90 | VMDC/CP NO | 80 | VMDCNO090E | 1.336,01 | VMDCNO090F | 2.113,20 | VMDCNO090P | 1.911,73 |
| 110 | VMDC/CP NO | 100 | VMDCNO110E | 2.029,18 | VMDCNO110F | 2.443,42 | VMDCNO110P | 2.133,01 |

Válvula neumática **NORMALMENTE ABIERTA.**

M-M encolar

DK/CP DE**VM/CP DE**

| d | Modelo. | DN | Ref. EPDM | € EPDM | Ref. FKM | € FKM | Ref. PTFE | € PTFE |
|-----|------------|-----|------------|-----------|------------|----------|------------|-----------|
| 20 | DKDC/CP DE | 15 | DKDCDA020E | 272,72 | DKDCDA020F | 375,90 | DKDCDA020P | 396,91 |
| 25 | DKDC/CP DE | 20 | DKDCDA025E | 291,11 | DKDCDA025F | 395,45 | DKDCDA025P | 416,94 |
| 32 | DKDC/CP DE | 25 | DKDCDA032E | 393,23 | DKDCDA032F | 465,69 | DKDCDA032P | 509,16 |
| 40 | DKDC/CP DE | 32 | DKDCDA040E | 436,98 | DKDCDA040F | 641,79 | DKDCDA040P | 689,92 |
| 50 | DKDC/CP DE | 40 | DKDCDA050E | 530,06 | DKDCDA050F | 760,68 | DKDCDA050P | 760,68 |
| 63 | DKDC/CP DE | 50 | DKDCDA063E | 674,92 | DKDCDA063F | 1.046,69 | DKDCDA063P | 1.046,69 |
| 75 | DKDC/CP DE | 65 | DKDCDA075E | 809,90 | DKDCDA075F | 1.256,02 | DKDCDA075P | 1.256,02 |
| 90 | VMDC/CP DE | 80 | VMDCDA090E | 1.621,07 | VMDCDA090F | 2.398,28 | VMDCDA090P | 2.196,78 |
| 110 | VMDC/CP DE | 100 | VMDCDA110E | 2.159,03 | VMDCDA110F | 2.773,05 | VMDCDA110P | 2.451,09 |

Válvula neumática **DOBLE EFECTO.**

M-M encolar



DK/CP NC

| d | Modelo. | DN | Ref. EPDM | € EPDM | Ref. FKM | € FKM | Ref. PTFE | € PTFE |
|----|-------------|----|-------------|-----------|-------------|----------|-------------|-----------|
| 20 | DKUIC/CP NC | 15 | DKUICNC020E | 411,28 | DKUICNC020F | 514,43 | DKUICNC020P | 535,91 |
| 25 | DKUIC/CP NC | 20 | DKUICNC025E | 430,95 | DKUICNC025F | 535,32 | DKUICNC025P | 569,69 |
| 32 | DKUIC/CP NC | 25 | DKUICNC032E | 530,12 | DKUICNC032F | 654,31 | DKUICNC032P | 697,34 |
| 40 | DKUIC/CP NC | 32 | DKUICNC040E | 700,53 | DKUICNC040F | 883,98 | DKUICNC040P | 928,03 |
| 50 | DKUIC/CP NC | 40 | DKUICNC050E | 793,77 | DKUICNC050F | 996,92 | DKUICNC050P | 996,92 |
| 63 | DKUIC/CP NC | 50 | DKUICNC063E | 1.103,21 | DKUICNC063F | 1.429,74 | DKUICNC063P | 1.429,74 |

Válvula neumática **NORMALMENTE CERRADA.**

Con enlaces H-H encolar



DK/CP NO

| d | Modelo. | DN | Ref. EPDM | € EPDM | Ref. FKM | € FKM | Ref. PTFE | € PTFE |
|----|-------------|----|-------------|-----------|-------------|----------|-------------|-----------|
| 20 | DKUIC/CP NO | 15 | DKUICNO020E | 373,15 | DKUICNO020F | 483,31 | DKUICNO020P | 524,68 |
| 25 | DKUIC/CP NO | 20 | DKUICNO025E | 394,13 | DKUICNO025F | 505,58 | DKUICNO025P | 562,26 |
| 32 | DKUIC/CP NO | 25 | DKUICNO032E | 475,40 | DKUICNO032F | 538,31 | DKUICNO032P | 597,38 |
| 40 | DKUIC/CP NO | 32 | DKUICNO040E | 523,39 | DKUICNO040F | 748,81 | DKUICNO040P | 808,86 |
| 50 | DKUIC/CP NO | 40 | DKUICNO050E | 610,58 | DKUICNO050F | 852,38 | DKUICNO050P | 852,38 |
| 63 | DKUIC/CP NO | 50 | DKUICNO063E | 787,90 | DKUICNO063F | 1.182,78 | DKUICNO063P | 1.182,78 |

Válvula neumática **NORMALMENTE ABIERTA.**

Con enlaces H-H encolar



DK/CP DE

| d | Modelo. | DN | Ref. EPDM | € EPDM | Ref. FKM | € FKM | Ref. PTFE | € PTFE |
|----|-------------|----|-------------|-----------|-------------|----------|-------------|-----------|
| 20 | DKUIC/CP DE | 15 | DKUICDA020E | 287,42 | DKUICDA020F | 390,61 | DKUICDA020P | 418,44 |
| 25 | DKUIC/CP DE | 20 | DKUICDA025E | 307,09 | DKUICDA025F | 411,46 | DKUICDA025P | 453,15 |
| 32 | DKUIC/CP DE | 25 | DKUICDA032E | 420,65 | DKUICDA032F | 575,29 | DKUICDA032P | 543,10 |
| 40 | DKUIC/CP DE | 32 | DKUICDA040E | 475,84 | DKUICDA040F | 680,76 | DKUICDA040P | 735,40 |
| 50 | DKUIC/CP DE | 40 | DKUICDA050E | 577,71 | DKUICDA050F | 806,49 | DKUICDA050P | 806,49 |
| 63 | DKUIC/CP DE | 50 | DKUICDA063E | 745,47 | DKUICDA063F | 1.119,11 | DKUICDA063P | 1.119,11 |

Válvula neumática **DOBLE EFECTO.**

Con enlaces H-H encolar



DK/CP NC

| Rh | Modelo. | DN | Ref. EPDM | € EPDM | Ref. FKM | € FKM | Ref. PTFE | € PTFE |
|--------|-------------|----|-------------|-----------|-------------|----------|-------------|-----------|
| 1/2" | DKUFC/CP NC | 15 | DKUFCNC012E | 452,43 | DKUFCNC012F | 509,28 | DKUFCNC012P | 565,88 |
| 3/4" | DKUFC/CP NC | 20 | DKUFCNC034E | 474,04 | DKUFCNC034F | 529,97 | DKUFCNC034P | 588,80 |
| 1" | DKUFC/CP NC | 25 | DKUFCNC100E | 583,11 | DKUFCNC100F | 719,76 | DKUFCNC100P | 767,09 |
| 1 1/4" | DKUFC/CP NC | 32 | DKUFCNC114E | 770,57 | DKUFCNC114F | 972,37 | DKUFCNC114P | 1.020,83 |
| 1 1/2" | DKUFC/CP NC | 40 | DKUFCNC112E | 873,13 | DKUFCNC112F | 1.096,59 | DKUFCNC112P | 1.096,59 |
| 2" | DKUFC/CP NC | 50 | DKUFCNC200E | 1.213,49 | DKUFCNC200F | 1.771,09 | DKUFCNC200P | 1.572,71 |

Válvula neumática **NORMALMENTE CERRADA.**

Con enlaces H-H roscar.



DK/CP NO

| Rh | Modelo. | DN | Ref. EPDM | € EPDM | Ref. FKM | € FKM | Ref. PTFE | € PTFE |
|--------|-------------|----|-------------|-----------|-------------|----------|-------------|-----------|
| 1/2" | DKUFC/CP NO | 15 | DKUFCNO012E | 417,08 | DKUFCNO012F | 477,82 | DKUFCNO012P | 538,23 |
| 3/4" | DKUFC/CP NO | 20 | DKUFCNO034E | 440,12 | DKUFCNO034F | 499,86 | DKUFCNO034P | 562,74 |
| 1" | DKUFC/CP NO | 25 | DKUFCNO100E | 523,09 | DKUFCNO100F | 592,15 | DKUFCNO100P | 657,14 |
| 1 1/4" | DKUFC/CP NO | 32 | DKUFCNO114E | 575,72 | DKUFCNO114F | 823,72 | DKUFCNO114P | 889,80 |
| 1 1/2" | DKUFC/CP NO | 40 | DKUFCNO112E | 671,66 | DKUFCNO112F | 937,64 | DKUFCNO112P | 937,64 |
| 2" | DKUFC/CP NO | 50 | DKUFCNO200E | 866,69 | DKUFCNO200F | 1.301,08 | DKUFCNO200P | 1.301,08 |

Válvula neumática **NORMALMENTE ABIERTA.**

Con enlaces H-H roscar.



DK/CP DE

| Rh | Modelo. | DN | Ref. EPDM | € EPDM | Ref. FKM | € FKM | Ref. PTFE | € PTFE |
|--------|-------------|----|-------------|-----------|-------------|----------|-------------|-----------|
| 1/2" | DKUFC/CP DE | 15 | DKUFCDA012E | 328,60 | DKUFCDA012F | 385,43 | DKUFCDA012P | 442,02 |
| 3/4" | DKUFC/CP DE | 20 | DKUFCDA034E | 350,20 | DKUFCDA034F | 406,11 | DKUFCDA034P | 464,99 |
| 1" | DKUFC/CP DE | 25 | DKUFCDA100E | 465,97 | DKUFCDA100F | 538,31 | DKUFCDA100P | 636,13 |
| 1 1/4" | DKUFC/CP DE | 32 | DKUFCDA114E | 523,39 | DKUFCDA114F | 748,81 | DKUFCDA114P | 808,91 |
| 1 1/2" | DKUFC/CP DE | 40 | DKUFCDA112E | 635,50 | DKUFCDA112F | 887,11 | DKUFCDA112P | 887,11 |
| 2" | DKUFC/CP DE | 50 | DKUFCDA200E | 820,00 | DKUFCDA200F | 1.231,00 | DKUFCDA200P | 1.231,00 |

Válvula neumática **DOBLE EFECTO.**

Con enlaces H-H roscar.



DK/CP NC



VM/CP NC

| d | Modelo. | DN | Ref. EPDM | € EPDM | Ref. FKM | € FKM | Ref. PTFE | € PTFE |
|-----|------------|-----|------------|-----------|------------|----------|------------|-----------|
| 20 | DKOC/CP NC | 15 | DKOCNC020E | 494,89 | DKOCNC020F | 578,99 | DKOCNC020P | 592,40 |
| 25 | DKOC/CP NC | 20 | DKOCNC025E | 497,98 | DKOCNC025F | 602,32 | DKOCNC025P | 616,35 |
| 32 | DKOC/CP NC | 25 | DKOCNC032E | 610,10 | DKOCNC032F | 735,81 | DKOCNC032P | 772,17 |
| 40 | DKOC/CP NC | 32 | DKOCNC040E | 800,72 | DKOCNC040F | 984,20 | DKOCNC040P | 1.023,34 |
| 50 | DKOC/CP NC | 40 | DKOCNC050E | 907,58 | DKOCNC050F | 1.110,65 | DKOCNC050P | 1.110,65 |
| 63 | DKOC/CP NC | 50 | DKOCNC063E | 1.252,56 | DKOCNC063F | 1.579,18 | DKOCNC063P | 1.550,08 |
| 75 | DKOC/CP NC | 65 | DKOCNC075E | 1.503,08 | DKOCNC075F | 1.894,99 | DKOCNC075P | 1.860,08 |
| 90 | VMOC/CP NC | 80 | VMOCNC090E | 2.177,57 | VMOCNC090F | 2.805,87 | VMOCNC090P | 2.473,70 |
| 110 | VMOC/CP NC | 100 | VMOCNC110E | 2.643,32 | VMOCNC110F | 3.260,00 | VMOCNC110P | 2.933,93 |

Válvula neumática **NORMALMENTE CERRADA.**

Con bridas DIN.

Disponibles con bridas ANSI 150 libras al mismo precio



DK/CP NO



VM/CP NO

| d | Modelo. | DN | Ref. EPDM | € EPDM | Ref. FKM | € FKM | Ref. PTFE | € PTFE |
|-----|------------|-----|------------|-----------|------------|----------|------------|-----------|
| 20 | DKOC/CP NO | 15 | DKOCNO020E | 442,11 | DKOCNO020F | 552,23 | DKOCNO020P | 586,64 |
| 25 | DKOC/CP NO | 20 | DKOCNO025E | 465,75 | DKOCNO025F | 577,14 | DKOCNO025P | 612,90 |
| 32 | DKOC/CP NO | 25 | DKOCNO032E | 479,70 | DKOCNO032F | 624,11 | DKOCNO032P | 672,90 |
| 40 | DKOC/CP NO | 32 | DKOCNO040E | 560,94 | DKOCNO040F | 852,72 | DKOCNO040P | 907,05 |
| 50 | DKOC/CP NO | 40 | DKOCNO050E | 726,59 | DKOCNO050F | 970,39 | DKOCNO050P | 970,39 |
| 63 | DKOC/CP NO | 50 | DKOCNO063E | 942,94 | DKOCNO063F | 1.335,89 | DKOCNO063P | 1.335,89 |
| 75 | DKOC/CP NO | 65 | DKOCNO075E | 1.131,51 | DKOCNO075F | 1.603,04 | DKOCNO075P | 1.603,04 |
| 90 | VMOC/CP NO | 80 | VMOCNO090E | 1.620,04 | VMOCNO090F | 2.397,22 | VMOCNO090P | 2.195,75 |
| 110 | VMOC/CP NO | 100 | VMOCNO110E | 2.295,56 | VMOCNO110F | 2.785,25 | VMOCNO110P | 2.390,45 |

Válvula neumática **NORMALMENTE ABIERTA.**

Con bridas DIN.

Disponibles con bridas ANSI 150 libras al mismo precio



DK/CP DE



VM/CP DE

| d | Modelo. | DN | Ref. EPDM | € EPDM | Ref. FKM | € FKM | Ref. PTFE | € PTFE |
|-----|------------|-----|------------|-----------|------------|----------|------------|-----------|
| 20 | DKOC/CP DE | 15 | DKOCDA020E | 352,00 | DKOCDA020F | 455,14 | DKOCDA020P | 474,62 |
| 25 | DKOC/CP DE | 20 | DKOCDA025E | 374,13 | DKOCDA025F | 478,47 | DKOCDA025P | 498,40 |
| 32 | DKOC/CP DE | 25 | DKOCDA032E | 501,43 | DKOCDA032F | 567,38 | DKOCDA032P | 611,72 |
| 40 | DKOC/CP DE | 32 | DKOCDA040E | 570,34 | DKOCDA040F | 775,21 | DKOCDA040P | 824,57 |
| 50 | DKOC/CP DE | 40 | DKOCDA050E | 887,11 | DKOCDA050F | 918,15 | DKOCDA050P | 918,15 |
| 63 | DKOC/CP DE | 50 | DKOCDA063E | 1.231,00 | DKOCDA063F | 1.263,96 | DKOCDA063P | 1.263,96 |
| 75 | DKOC/CP DE | 65 | DKOCDA075E | 687,49 | DKOCDA075F | 1.516,75 | DKOCDA075P | 1.516,75 |
| 90 | VMOC/CP DE | 80 | VMOCDA090E | 1.905,09 | VMOCDA090F | 2.682,36 | VMOCDA090P | 2.480,84 |
| 110 | VMOC/CP DE | 100 | VMOCDA110E | 2.408,74 | VMOCDA110F | 3.116,50 | VMOCDA110P | 2.700,81 |

Válvula neumática **DOBLE EFECTO.**

Con bridas DIN.

Disponibles con bridas ANSI 150 libras al mismo precio

CMDC/CP NC*M-M encolar***CMUIC/CP NC***H-H enlaces encolar*

| d | Ref. EPDM | DN | € EPDM | € FKM | € PTFE |
|----|--------------------|----|---------------|---------------|-------------------|
| 20 | CMDCNC020E | 15 | 249,88 | 271,51 | 271,51 |
| 20 | CMUICNC020E | 15 | 299,01 | 326,44 | 326,44 (A) |

Válvula de membrana.
compacta neumática
NORMALMENTE CERRADA.

Código en FKM termina en "F"
en lugar de "E"
Código en PTFE termina en "F"
en lugar de "E"
(A) Juntas en FKM

CMDC/CP NO*M-M encolar***CMUIC/CP NO***H-H enlaces encolar*

| d | Ref. EPDM | DN | € EPDM | € FKM | € PTFE |
|----|--------------------|----|---------------|---------------|-------------------|
| 20 | CMDCNO020E | 15 | 245,53 | 268,62 | 268,62 |
| 20 | CMUICNO020E | 15 | 294,66 | 323,52 | 323,52 (A) |

Válvula de membrana.
compacta neumática
NORMALMENTE ABIERTA.

Código en FKM termina en "F"
en lugar de "E"
Código en PTFE termina en "F"
en lugar de "E"
(A) Juntas en FKM

CMDC/CP DA*M-M encolar***CMUIC/CP DA***H-H enlaces encolar*

| d | Ref. EPDM | DN | € EPDM | € FKM | € PTFE |
|----|--------------------|----|---------------|---------------|-------------------|
| 20 | CMDCDA020E | 15 | 245,53 | 268,62 | 268,62 |
| 20 | CMUICDA020E | 15 | 294,66 | 323,52 | 323,52 (A) |

Válvula de membrana.
compacta neumática
DOBLE EFECTO.

Código en FKM termina en "F"
en lugar de "E"
Código en PTFE termina en "F"
en lugar de "E"
(A) Juntas en FKM

DKBDC/CP NC



| d | Ref. EPDM | DN | PN | € EPDM |
|----|-------------|----|----|-----------|
| 20 | DKBDCNC020E | 15 | 6 | 384,14 |
| 25 | DKBDCNC025E | 20 | 6 | 403,30 |
| 32 | DKBDCNC032E | 25 | 6 | 501,70 |
| 40 | DKBDCNC040E | 32 | 6 | 625,77 |
| 50 | DKBDCNC050E | 40 | 6 | 650,62 |
| 63 | DKBDCNC063E | 50 | 6 | 911,41 |
| 75 | DKBDCNC075E | 65 | 6 | 1.074,37 |

Válvula de membrana neumática
NORMALMENTE CERRADA.

Actuador a pistón

M-M encolar

DKBUIC/CP NC



| d | Ref. EPDM | DN | PN | € EPDM |
|----|--------------|----|----|-----------|
| 20 | DKBUICNC020E | 15 | 6 | 937,21 |
| 25 | DKBUICNC025E | 20 | 6 | 636,50 |
| 32 | DKBUICNC032E | 25 | 6 | 674,82 |
| 40 | DKBUICNC040E | 32 | 6 | 385,57 |
| 50 | DKBUICNC050E | 40 | 6 | 407,40 |
| 63 | DKBUICNC063E | 50 | 6 | 511,52 |

Válvula de membrana neumática
NORMALMENTE CERRADA.

Actuador a pistón

Con enlaces H-H encolar

DKBUFC/CP NC



| d | Ref. EPDM | DN | PN | € EPDM |
|------|--------------|----|----|-----------|
| ½" | DKBUFCNC012E | 15 | 6 | 385,57 |
| ¾" | DKBUFCNC034E | 20 | 6 | 407,40 |
| 1" | DKBUFCNC100E | 25 | 6 | 511,52 |
| 1 ¼" | DKBUFCNC114E | 32 | 6 | 636,50 |
| 1 ½" | DKBUFCNC112E | 40 | 6 | 674,82 |
| 2" | DKBUFCNC200E | 50 | 6 | 937,21 |

Válvula de membrana neumática
NORMALMENTE CERRADA.

Actuador a pistón

Con enlaces H-H para roscar

DKBOC/CP NC



| d | Ref. EPDM | DN | PN | € EPDM |
|----|-------------|----|----|-----------|
| 20 | DKBOCNC020E | 15 | 6 | 441,73 |
| 25 | DKBOCNC025E | 20 | 6 | 463,75 |
| 32 | DKBOCNC032E | 25 | 6 | 587,80 |
| 40 | DKBOCNC040E | 32 | 6 | 739,51 |
| 50 | DKBOCNC050E | 40 | 6 | 768,87 |
| 63 | DKBOCNC063E | 50 | 6 | 1.077,12 |
| 75 | DKBOCNC075E | 65 | 6 | 1.375,48 |

Válvula de membrana neumática
NORMALMENTE CERRADA.

Actuador a pistón

Con bridas DIN

DKBOAC/CP NC



| d | Ref. EPDM | DN | PN | € EPDM |
|------|--------------|----|----|-----------|
| ½" | DKBOACNC012E | 15 | 6 | 441,73 |
| ¾" | DKBOACNC034E | 20 | 6 | 463,75 |
| 1" | DKBOACNC100E | 25 | 6 | 587,80 |
| 1 ¼" | DKBOACNC114E | 32 | 6 | 739,51 |
| 1 ½" | DKBOACNC112E | 40 | 6 | 768,87 |
| 2" | DKBOACNC200E | 50 | 6 | 1.077,12 |
| 2 ½" | DKBOACNC212E | 65 | 6 | 1.375,48 |

Válvula de membrana neumática
NORMALMENTE CERRADA.

Actuador a pistón

Con bridas ANSI 150 lbs



MANGUITO

| d | Ref. | Para válvulas | € |
|-----|--------------------|--------------------|---------------|
| 16 | ENDIC016 | VKD-TKD-VXE-SXE-RV | 27,45 |
| 20 | ENDIC020 | VKD-TKD-VXE-SXE-RV | 27,45 |
| 25 | ENDIC025 | VKD-TKD-VXE-SXE-RV | 46,59 |
| 32 | ENDIC032 | VKD-TKD-VXE-SXE-RV | 49,34 |
| 40 | ENDIC040 | VKD-TKD-VXE-SXE-RV | 54,85 |
| 50 | ENDIC050 | VKD-TKD-VXE-SXE-RV | 60,31 |
| 63 | ENDIC063 | VKD-TKD-VXE-SXE-RV | 68,58 |
| 75 | ENDIC075 | VKD-VXE-SSE | 82,25 |
| 90 | ENDIC090 | VKD | 120,66 |
| 90 | ENDIC090VXE | VXE-SXE | 120,66 |
| 110 | ENDIC110 | VKD | 150,79 |
| 110 | ENDIC110VXE | VXE-SXE | 150,79 |

Conector final en C-PVC.
H encolar.



MANGUITO

| Rh | Ref. | Para válvulas | € |
|--------|--------------------|--------------------|---------------|
| 3/8" | ENDFC038 | VKD-TKD-VXE-SXE-RV | 27,45 |
| 1/2" | ENDFC012 | VKD-TKD-VXE-SXE-RV | 27,45 |
| 3/4" | ENDFC034 | VKD-TKD-VXE-SXE-RV | 46,59 |
| 1" | ENDFC100 | VKD-TKD-VXE-SXE-RV | 49,34 |
| 1 1/4" | ENDFC114 | VKD-TKD-VXE-SXE-RV | 54,85 |
| 1 1/2" | ENDFC112 | VKD-TKD-VXE-SXE-RV | 60,31 |
| 2" | ENDFC200 | VKD | 68,58 |
| 2 1/2" | ENDFC212 | VKD | 82,25 |
| 3" | ENDFC300 | VKD | 120,66 |
| 3" | ENDFC300VXE | VXE-SXE | 120,66 |
| 4" | ENDFC400 | VKD | 150,79 |
| 4" | ENDFC400VXE | VXE-SXE | 150,79 |

Conector final en C-PVC.
H rosca GAS.



MANGUITO

| d | Ref. | Para válvulas | € |
|--------|--------------------|--------------------|---------------|
| 1/2" | ENDAC012 | VKD-TKD-VXE-SXE-RV | 27,45 |
| 3/4" | ENDAC034 | VKD-TKD-VXE-SXE-RV | 46,59 |
| 1" | ENDAC100 | VKD-TKD-VXE-SXE-RV | 49,34 |
| 1 1/4" | ENDAC114 | VKD-TKD-VXE-SXE-RV | 54,85 |
| 1 1/2" | ENDAC112 | VKD-TKD-VXE-SXE-RV | 60,31 |
| 2" | ENDAC200 | VKD-TKD-VXE-SXE-RV | 68,58 |
| 2 1/2" | ENDAC212 | VKD | 82,25 |
| 3" | ENDAC300 | VKD | 120,66 |
| 3" | ENDAC300VXE | VXE-SXE | 120,66 |
| 4" | ENDAC400 | VKD | 150,79 |
| 4" | ENDAC400VXE | VXE-SXE | 150,79 |

Conector final en C-PVC.
H encolar serie ASTM.



MANGUITO

| d | Ref. | Para válvulas | € |
|-----|--------------------|--------------------|---------------|
| 16 | ENDDC016 | VKD-TKD-VXE-SXE-RV | 27,45 |
| 20 | ENDDC020 | VKD-TKD-VXE-SXE-RV | 27,45 |
| 25 | ENDDC025 | VKD-TKD-VXE-SXE-RV | 46,59 |
| 32 | ENDDC032 | VKD-TKD-VXE-SXE-RV | 49,34 |
| 40 | ENDDC040 | VKD-TKD-VXE-SXE-RV | 54,85 |
| 50 | ENDDC050 | VKD-TKD-VXE-SXE-RV | 60,31 |
| 63 | ENDDC063 | VKD-TKD-VXE-SXE-RV | 68,58 |
| 75 | ENDDC075 | VKD | 82,25 |
| 90 | ENDDC090 | VKD | 120,66 |
| 90 | ENDDC090VXE | VXE-SSE | 120,66 |
| 110 | ENDDC110 | VKD | 150,79 |
| 110 | ENDDC110VXE | VXE-SSE | 150,79 |

Conector final en C-PVC.
M encolar.



MANGUITO

| Rh | Ref. | Para válvulas | € |
|--------|--------------------|--------------------|---------------|
| 1/2" | ENDNC012 | VKD-TKD-VXE-SXE-RV | 27,45 |
| 3/4" | ENDNC034 | VKD-TKD-VXE-SXE-RV | 46,59 |
| 1" | ENDNC100 | VKD-TKD-VXE-SXE-RV | 49,34 |
| 1 1/4" | ENDNC114 | VKD-TKD-VXE-SXE-RV | 54,85 |
| 1 1/2" | ENDNC112 | VKD-TKD-VXE-SXE-RV | 60,31 |
| 2" | ENDNC200 | VKD | 68,58 |
| 2 1/2" | ENDNC212 | VKD | 82,25 |
| 3" | ENDNC300 | VKD | 120,66 |
| 3" | ENDNC300VXE | VXE-SXE | 120,66 |
| 4" | ENDNC400 | VKD | 150,79 |
| 4" | ENDNC400VXE | VXE-SXE | 150,79 |

Conector final en C-PVC.
H rosca NPT



0810

Accesorios mecánicos para la unión de tuberías

INDUSTRIA



Más información





Accesorios mecánicos





METAL GRIP

| diámetro exterior | PN (bar) | PN (bar) | CARCASA EN ACERO GALVANIZADO | | | | CARCASA EN ACERO INOXIDABLE | | | |
|-------------------|----------|----------|------------------------------|----------|----------|----------|-----------------------------|----------|----------|----------|
| | | | Ref. EPDM | € EPDM | Ref. NBR | € NBR | Ref. EPDM | € EPDM | Ref. NBR | € NBR |
| 30,0 | 67,0 | 16,0 | 50 | 183,66 | 51 | 183,66 | 58 | 218,75 | 57 | 218,75 |
| 33,7 | 62,0 | 16,0 | 86 | 184,95 | 123 | 184,95 | 126 | 220,91 | 127 | 220,91 |
| 38,0 | 58,0 | 16,0 | 110 | 185,85 | 122 | 185,85 | 40100 | 220,91 | 40101 | 220,91 |
| 42,4 | 53,0 | 16,0 | 11045 | 187,34 | 11047 | 187,34 | 40150 | 223,08 | 40151 | 223,08 |
| 44,5 | 48,0 | 16,0 | 129 | 188,42 | 130 | 188,42 | 40200 | 223,08 | 40201 | 223,08 |
| 48,3 | 44,0 | 16,0 | 11048 | 191,27 | 11050 | 191,27 | 40250 | 225,27 | 40251 | 225,27 |
| 54,0 | 39,0 | 16,0 | 8669 | 192,33 | 8671 | 192,33 | 8668 | 227,43 | 8670 | 227,43 |
| 57,0 | 37,0 | 16,0 | 11052 | 193,85 | 11051 | 193,85 | 11043 | 229,60 | 11053 | 229,60 |
| 60,3 | 37,0 | 16,0 | 11054 | 197,52 | 11056 | 197,52 | 11044 | 231,75 | 11055 | 231,75 |
| 63,5 | 37,0 | 16,0 | 209 | 204,89 | 210 | 204,89 | 211 | 240,43 | 212 | 240,43 |
| 73,0 | 56,0 | 16,0 | 186 | 229,60 | 187 | 229,60 | 104105 | 272,93 | 192 | 272,93 |
| 76,1 | 56,0 | 16,0 | 215 | 233,92 | 155 | 233,92 | 40450 | 277,26 | 40451 | 277,26 |
| 84,0 | 45,0 | 16,0 | 216 | 249,10 | 156 | 249,10 | 104060 | 290,24 | 102278 | 290,24 |
| 88,9 | 41,0 | 16,0 | 135 | 251,23 | 157 | 251,23 | 40550 | 294,55 | 40551 | 294,55 |
| 104,0 | 37,0 | 16,0 | 136 | 279,39 | 158 | 279,39 | 173 | 318,40 | 197 | 318,40 |
| 108,0 | 35,0 | 16,0 | 137 | 283,72 | 159 | 283,72 | 40650 | 322,73 | 40651 | 322,73 |
| 114,3 | 34,0 | 16,0 | 138 | 296,76 | 160 | 296,76 | 40700 | 337,90 | 40701 | 337,90 |
| 129,0 | 33,0 | 16,0 | 139 | 400,70 | 161 | 400,70 | 40600 | 470,01 | 40601 | 470,01 |
| 133,0 | 33,0 | 16,0 | 140 | 411,54 | 162 | 411,54 | 40602 | 478,68 | 40603 | 478,68 |
| 139,7 | 32,0 | 16,0 | 141 | 457,01 | 163 | 457,01 | 40614 | 526,33 | 40611 | 526,33 |
| 154,0 | 32,0 | 16,0 | 142 | 502,50 | | | 40622 | 571,81 | | |
| 159,0 | 31,0 | 16,0 | 143 | 508,99 | 165 | 508,99 | 40634 | 578,29 | 40631 | 578,29 |
| 168,3 | 29,0 | 16,0 | 144 | 541,47 | 166 | 541,47 | 40655 | 608,63 | 40652 | 608,63 |
| 180,0 | 29,0 | 16,0 | 1650 | 968,15 | 1651 | 968,15 | | | | |
| 193,7 | 29,0 | 16,0 | 1537 | 991,96 | 1542 | 991,96 | | | | |
| 200,0 | 28,0 | 15,0 | 1652 | 1.005,01 | 1653 | 1.005,01 | | | | |
| 206,0 | 28,0 | 15,0 | 1641 | 1.015,82 | 1654 | 1.015,82 | | | | |
| 219,1 | 26,0 | 16,0 | 145 | 1.080,78 | 167 | 1.080,78 | 41050 | 1.208,56 | 41051 | 1.208,56 |
| 244,5 | 27,0 | 14,0 | 1572 | 1.089,46 | 1573 | 1.089,46 | | | | |
| 267,0 | 24,0 | 12,0 | 1574 | 1.130,58 | 1575 | 1.130,58 | | | | |
| 273,0 | 21,0 | 12,0 | 1567 | 1.178,25 | 1568 | 1.178,25 | | | | |
| 323,9 | 18,0 | 10,0 | 1576 | 1.241,06 | 1577 | 1.241,06 | | | | |
| 355,6 | 17,0 | 8,0 | 1579 | 1.295,22 | 1578 | 1.295,22 | | | | |
| 406,4 | 14,0 | 8,0 | 1607 | 1.405,69 | 1608 | 1.405,69 | | | | |
| 457,2 | 8,0 | 6,0 | 1609 | 1.518,31 | 1610 | 1.518,31 | | | | |
| 508,0 | 6,0 | 5,0 | 1611 | 1.637,44 | 1612 | 1.637,44 | | | | |
| 558,8 | 6,0 | 4,5 | 1613 | 1.756,54 | 1614 | 1.756,54 | | | | |
| 609,6 | 5,0 | 4,0 | 1615 | 1.875,68 | 1616 | 1.875,68 | | | | |

Acoplamiento para tubos metálicos con anclaje axial.

Acoplamiento para muy alta presión de alta calidad.

Máximo rendimiento.



Junta: EPDM: -30°C hasta +100°C NBR: -20°C hasta +80°C

Fluido: EPDM: Todas las calidades de agua, aguas residuales, aire, sólidos y diversos productos químicos.

NBR: Agua, gas, aceite, combustible y otros hidrocarburos.



METAL GRIP FIRE FENCE

| diámetro exterior |  PN (bar) |  PN (bar) | CARCASA EN ACERO GALVANIZADO | | | | CARCASA EN ACERO INOXIDABLE | | | |
|-------------------|--|--|------------------------------|----------|----------|----------|-----------------------------|----------|----------|----------|
| | | | Ref. EPDM | € EPDM | Ref. NBR | € NBR | Ref. EPDM | € EPDM | Ref. NBR | € NBR |
| 30,0 | 67,0 | 16,0 | 19299 | 294,56 | 19349 | 294,56 | 105039 | 327,05 | 105026 | 327,05 |
| 33,7 | 62,0 | 16,0 | 19300 | 296,76 | 19350 | 296,76 | 105040 | 329,21 | 105027 | 329,21 |
| 38,0 | 58,0 | 16,0 | 19301 | 298,89 | 19351 | 298,89 | 105041 | 331,39 | 105028 | 331,39 |
| 42,4 | 53,0 | 16,0 | 19302 | 301,07 | 19352 | 301,07 | 105042 | 335,71 | 105029 | 335,71 |
| 44,5 | 48,0 | 16,0 | 19303 | 301,07 | 19353 | 301,07 | 40206 | 335,71 | 105030 | 335,71 |
| 48,3 | 44,0 | 16,0 | 19304 | 303,22 | 19354 | 303,22 | 105043 | 337,90 | 105031 | 337,90 |
| 54,0 | 39,0 | 16,0 | 19305 | 307,56 | 19355 | 307,56 | 19405 | 346,56 | 19455 | 346,56 |
| 57,0 | 37,0 | 16,0 | 19306 | 307,56 | 19356 | 307,56 | 19406 | 346,56 | 19456 | 346,56 |
| 60,3 | 37,0 | 16,0 | 19307 | 311,89 | 19357 | 311,89 | 19407 | 350,90 | 19457 | 350,90 |
| 63,5 | 37,0 | 16,0 | 19433 | 314,08 | 19432 | 314,08 | 19430 | 353,03 | 19431 | 353,03 |
| 76,1 | 56,0 | 16,0 | 19308 | 355,22 | 19358 | 355,22 | 105044 | 394,19 | 105032 | 394,19 |
| 84,0 | 45,0 | 16,0 | 19309 | 370,40 | 19359 | 370,40 | 19551 | 411,55 | 19552 | 411,55 |
| 88,9 | 41,0 | 16,0 | 19310 | 372,53 | 19360 | 372,53 | 105045 | 413,69 | 105033 | 413,69 |
| 104,0 | 37,0 | 16,0 | 19311 | 400,70 | 19361 | 400,70 | 19571 | 444,04 | 19572 | 444,04 |
| 108,0 | 35,0 | 16,0 | 19312 | 402,85 | 19362 | 402,85 | 105046 | 446,18 | 105034 | 446,18 |
| 114,3 | 34,0 | 16,0 | 19314 | 428,85 | 19364 | 428,85 | 105047 | 467,84 | 105035 | 467,84 |
| 129,0 | 33,0 | 16,0 | 19315 | 589,15 | 19365 | 589,15 | 19585 | 658,44 | 19568 | 658,44 |
| 133,0 | 33,0 | 16,0 | 19316 | 597,80 | 19366 | 597,80 | 19594 | 667,10 | 19593 | 667,10 |
| 139,7 | 32,0 | 16,0 | 19317 | 690,94 | 19367 | 690,94 | 105048 | 760,24 | 105036 | 760,24 |
| 154,0 | 32,0 | 16,0 | 19318 | 764,59 | | | 19601 | 833,89 | | |
| 159,0 | 31,0 | 16,0 | 19319 | 773,23 | 19369 | 773,23 | 19603 | 842,56 | 19604 | 842,56 |
| 168,3 | 29,0 | 16,0 | 19321 | 827,38 | 19371 | 827,38 | 105049 | 896,68 | 19635 | 896,68 |
| 219,1 | 26,0 | 16,0 | 19323 | 1.641,76 | 19373 | 1.641,76 | 105050 | 1.773,90 | 105038 | 1.773,90 |
| 244,5 | 27,0 | 14,0 | 19324 | 1.923,33 | 19378 | 1.923,33 | | | | |
| 267,0 | 24,0 | 12,0 | 19325 | 1.986,15 | 19380 | 1.986,15 | | | | |
| 273,0 | 21,0 | 12,0 | 19326 | 2.033,78 | 19379 | 2.033,78 | | | | |
| 323,9 | 18,0 | 10,0 | 19327 | 2.139,93 | 19381 | 2.139,93 | | | | |
| 355,6 | 17,0 | 8,0 | 19328 | 2.239,57 | 19383 | 2.239,57 | | | | |
| 406,4 | 14,0 | 8,0 | 19329 | 2.414,99 | 19384 | 2.414,99 | | | | |
| 457,2 | 8,0 | 6,0 | 19330 | 2.601,27 | 19385 | 2.601,27 | | | | |

Acoplamiento para tubos metálicos con anclaje axial y con protección al fuego.

Acoplamientos para muy alta presión de alta calidad.

Máximo rendimiento.

Junta: EPDM: -30°C hasta +100°C NBR: -20°C hasta +80°C

Fluido: EPDM: Todas las calidades de agua, aguas residuales, aire, sólidos y diversos productos químicos.

NBR: Agua, gas, aceite, combustible y otros hidrocarburos.



GRIP

CARCASA EN ACERO INOXIDABLE



| diámetro exterior | PN (bar) | PN (bar) | Ref. EPDM | € EPDM | Ref. NBR | € NBR | Ref. FKM | € FKM |
|-------------------|----------|----------|-----------|--------|----------|--------|----------|--------|
| 25,0 | 64,0 | 16,0 | G20041 | 80,16 | G20040 | 80,16 | G20043 | 174,99 |
| 26,9 | 58,0 | 16,0 | G20000 | 81,43 | G20001 | 81,43 | G20011 | 176,29 |
| 28,0 | 50,0 | 16,0 | G20025 | 82,30 | G20026 | 82,30 | G20027 | 177,18 |
| 30,0 | 42,0 | 16,0 | G20050 | 83,62 | G20051 | 83,62 | G20054 | 178,49 |
| 33,7 | 39,0 | 16,0 | G20100 | 86,18 | G20101 | 86,18 | G20110 | 178,49 |
| 35,0 | 37,0 | 16,0 | G20124 | 90,31 | G20125 | 90,31 | G20126 | 178,49 |
| 38,0 | 36,0 | 16,0 | G20150 | 99,63 | G20151 | 99,63 | G20164 | 178,49 |
| 40,0 | 35,0 | 16,0 | G20175 | 100,92 | G20176 | 100,92 | G20177 | 179,58 |
| 42,4 | 33,0 | 16,0 | G20200 | 102,46 | G20201 | 102,46 | G20206 | 180,63 |
| 44,5 | 30,0 | 16,0 | G20250 | 104,84 | G20251 | 104,84 | G20253 | 180,63 |
| 48,3 | 28,0 | 16,0 | G20300 | 107,45 | G20301 | 107,45 | G20306 | 183,02 |
| 54,0 | 24,0 | 16,0 | G20350 | 120,42 | G20351 | 120,42 | G20360 | 183,02 |
| 57,0 | 23,0 | 16,0 | G20400 | 123,45 | G20401 | 123,45 | G20406 | 187,34 |
| 60,3 | 23,0 | 16,0 | G20450 | 125,89 | G20451 | 125,85 | G20456 | 191,91 |
| 63,0 | 23,0 | 16,0 | G20425 | 137,98 | G20426 | 137,98 | G20427 | 211,82 |
| 66,6 | 22,0 | 16,0 | G20470 | 154,20 | G20471 | 154,20 | G20476 | 238,24 |
| 70,0 | 22,0 | 16,0 | G20485 | 156,58 | G20486 | 156,58 | G20494 | 240,43 |
| 73,0 | 21,0 | 16,0 | G20500 | 160,50 | G20501 | 160,50 | G20506 | 240,43 |
| 76,1 | 35,0 | 16,0 | G20550 | 164,00 | G20551 | 163,96 | G20558 | 244,74 |
| 79,5 | 32,0 | 16,0 | G20570 | 166,98 | G20583 | 166,98 | G20584 | 247,56 |
| 84,0 | 29,0 | 16,0 | G20600 | 171,75 | G20601 | 171,75 | G20606 | 249,10 |
| 88,9 | 26,0 | 16,0 | G20650 | 176,77 | G20651 | 176,74 | G20656 | 255,58 |
| 95,0 | 24,0 | 16,0 | G20667 | 180,21 | G20677 | 180,21 | G20678 | 259,92 |
| 98,0 | 24,0 | 16,0 | G20690 | 181,90 | G20691 | 181,90 | G20692 | 259,92 |
| 100,6 | 23,0 | 16,0 | G20700 | 183,44 | G20701 | 183,44 | G20706 | 262,06 |
| 101,6 | 23,0 | 16,0 | G20750 | 184,12 | G20751 | 184,12 | | |
| 104,0 | 23,0 | 16,0 | G20800 | 184,12 | G20801 | 184,12 | | |
| 104,8 | 23,0 | 16,0 | G20825 | 186,07 | G20826 | 186,07 | | |
| 108,0 | 22,0 | 16,0 | G20850 | 189,96 | G20851 | 189,96 | G20865 | 264,28 |
| 114,3 | 22,0 | 16,0 | G20900 | 195,63 | G20901 | 195,59 | G20906 | 268,59 |
| 118,0 | 22,0 | 16,0 | G20930 | 198,83 | G20931 | 198,83 | G20932 | 270,73 |
| 125,0 | 21,0 | 16,0 | G20940 | 277,25 | G20941 | 277,25 | G20942 | 290,24 |

Acoplamiento para tubos metálicos
con anclaje axial.

Acoplamiento para alta presión de alta calidad.

Continúa en la página siguiente...

CARCASA EN ACERO INOXIDABLE

| diámetro exterior |  PN (bar) |  PN (bar) | Ref. EPDM | € EPDM | Ref. NBR | € NBR | Ref. FKM | € FKM |
|-------------------|--|--|-----------|----------|----------|----------|----------|----------|
| 127,0 | 21,0 | 16,0 | G20950 | 279,39 | G20951 | 279,39 | G20957 | 298,89 |
| 129,0 | 21,0 | 16,0 | G21000 | 281,57 | G21001 | 281,57 | G21006 | 311,89 |
| 130,2 | 21,0 | 16,0 | G21050 | 281,57 | G21051 | 281,57 | G21052 | 318,40 |
| 133,0 | 21,0 | 16,0 | G21100 | 283,72 | G21101 | 283,72 | G21112 | 337,90 |
| 139,7 | 20,0 | 16,0 | G21150 | 290,30 | G21151 | 290,30 | G21165 | 379,05 |
| 141,3 | 20,0 | 16,0 | G21200 | 292,39 | G21201 | 292,39 | G21208 | 387,70 |
| 144,0 | 20,0 | 16,0 | G21225 | 294,56 | G21226 | 294,56 | G21227 | 405,04 |
| 154,0 | 18,0 | 16,0 | G21250 | 301,07 | G21251 | 301,07 | G21262 | 467,84 |
| 159,0 | 18,0 | 16,0 | G21300 | 305,40 | G21301 | 305,40 | G21309 | 500,32 |
| 165,0 | 16,0 | 16,0 | G21328 | 311,89 | G21326 | 311,89 | G21331 | 537,12 |
| 168,3 | 16,0 | 16,0 | G21350 | 314,13 | G21351 | 314,08 | G21369 | 558,81 |
| 219,1 | 16,0 | 10,0 | 21400 | 550,13 | 21401 | 550,13 | 21408 | 725,57 |
| 180,0 | 16,0 | 10,0 | 24950 | 771,04 | 24952 | 771,04 | 24955 | 818,71 |
| 193,7 | 16,0 | 10,0 | 25000 | 790,54 | 25002 | 790,54 | 25007 | 836,02 |
| 200,0 | 15,0 | 10,0 | 25010 | 799,20 | 25012 | 799,20 | 25015 | 844,67 |
| 204,0 | 14,0 | 10,0 | 25050 | 801,41 | 25052 | 801,41 | 25049 | 851,22 |
| 206,0 | 14,0 | 5,5 | 25058 | 801,41 | 25068 | 801,41 | 25072 | 851,22 |
| 244,5 | 9,0 | 5,5 | 25100 | 818,71 | 25102 | 818,71 | 25106 | 875,04 |
| 250,0 | 9,0 | 5,5 | 25110 | 823,05 | 25112 | 823,05 | 25115 | 888,03 |
| 254,0 | 9,0 | 5,5 | 25125 | 827,38 | 25127 | 827,38 | 25131 | 896,68 |
| 256,0 | 9,0 | 5,5 | 25140 | 827,38 | 25143 | 827,38 | 25145 | 896,68 |
| 267,0 | 8,0 | 5,0 | 25150 | 836,02 | 25152 | 836,02 | 25157 | 924,86 |
| 273,0 | 7,0 | 4,0 | 25200 | 838,21 | 25202 | 838,21 | 25207 | 937,84 |
| 306,0 | 6,0 | 3,0 | 25260 | 862,05 | 25263 | 862,05 | 25265 | 1.005,01 |
| 323,9 | 5,0 | 3,0 | 25300 | 881,50 | 25302 | 881,50 | 25309 | 1.048,29 |
| 355,6 | 10,0 | 2,5 | 25353 | 924,86 | 25352 | 924,86 | 25351 | 1.464,16 |
| 406,4 | 7,0 | 2,0 | 25413 | 989,83 | 25403 | 989,83 | 25402 | 1.565,96 |
| 457,2 | 5,0 | | 25434 | 1.059,14 | 25435 | 1.059,14 | 25436 | 1.678,59 |
| 508,0 | 4,0 | | 25453 | 1.124,11 | 25452 | 1.124,11 | 25462 | 1.778,25 |
| 558,8 | 3,0 | | 25483 | 1.191,26 | 25484 | 1.191,26 | 25485 | 1.886,51 |
| 609,6 | 2,0 | | 25517 | 1.256,24 | 25518 | 1.256,24 | 25519 | 1.994,83 |
| 711,2 | 1,0 | | 26001 | 1.392,67 | 26002 | 1.392,67 | 26003 | 2.211,41 |

Junta: EPDM: -20°C hasta +100°C NBR: -20°C hasta +80°C FKM: -20°C hasta +180°C

Fluido: EPDM: Todas las calidades de agua, aguas residuales, aire, sólidos y diversos productos químicos.



NBR: Agua, gas, aceite, combustible y otros hidrocarburos.

FKM: Ozono, oxígeno, ácidos, gas, aceite y carburantes.



GRIP

CARCASA EN ACERO GALVANIZADO

| diámetro exterior |  PN (bar) |  PN (bar) | Ref. EPDM | € EPDM | Ref. NBR | € NBR | Ref. FKM | € FKM |
|-------------------|--|--|-----------|----------|----------|----------|----------|----------|
| 180,0 | 16,0 | 10,0 | 24951 | 703,94 | 24953 | 703,94 | 24954 | 751,59 |
| 193,7 | 16,0 | 10,0 | 25001 | 723,41 | 25003 | 723,41 | 25006 | 768,91 |
| 200,0 | 15,0 | 10,0 | 25011 | 732,06 | 25013 | 732,06 | 25014 | 777,59 |
| 204,0 | 14,0 | 10,0 | 25051 | 734,22 | 25053 | 734,22 | 25048 | 786,22 |
| 206,0 | 14,0 | 5,5 | 25066 | 734,22 | 25067 | 734,22 | 25069 | 786,22 |
| 244,5 | 9,0 | 5,5 | 25101 | 751,59 | 25103 | 751,59 | 25105 | 807,88 |
| 250,0 | 9,0 | 5,5 | 25111 | 758,05 | 25113 | 758,05 | 25114 | 820,87 |
| 254,0 | 9,0 | 5,5 | 25126 | 760,24 | 25128 | 760,24 | 25132 | 829,56 |
| 256,0 | 9,0 | 5,5 | 25141 | 760,24 | 25142 | 760,24 | 25144 | 829,56 |
| 267,0 | 8,0 | 5,0 | 25151 | 768,91 | 25153 | 768,91 | 25156 | 859,86 |
| 273,0 | 7,0 | 4,0 | 25201 | 771,04 | 25203 | 771,04 | 25198 | 870,69 |
| 306,0 | 6,0 | 3,0 | 25261 | 794,88 | 25262 | 794,88 | 25264 | 937,84 |
| 323,9 | 5,0 | 3,0 | 25301 | 814,38 | 25303 | 814,38 | 25315 | 981,16 |
| 355,6 | 10,0 | 2,5 | 101099 | 859,86 | 101100 | 859,86 | 101101 | 1.373,20 |
| 406,4 | 7,0 | 2,0 | 101102 | 922,69 | 101103 | 922,69 | 101104 | 1.477,16 |
| 457,2 | 5,0 | | 101105 | 991,96 | 101106 | 991,96 | 101107 | 1.587,64 |
| 508,0 | 4,0 | | 101108 | 1.054,80 | 101109 | 1.054,80 | 101110 | 1.689,41 |
| 558,8 | 3,0 | | 101111 | 1.124,11 | 101112 | 1.124,11 | 101113 | 1.797,69 |
| 609,6 | 2,0 | | 101114 | 1.191,26 | 101115 | 1.191,26 | 101116 | 1.906,01 |
| 711,2 | 1,0 | | 26000 | 1.327,72 | 101117 | 1.327,72 | 101118 | 2.122,61 |

Acoplamiento para tubos metálicos con anclaje axial.

Acoplamientos para alta presión de alta calidad.

Junta: EPDM: -20°C hasta +100°C NBR: -20°C hasta +80°C FKM: -20°C hasta +180°C

Fluido: EPDM: Todas las calidades de agua, aguas residuales, aire, sólidos y diversos productos químicos.



NBR: Agua, gas, aceite, combustible y otros hidrocarburos.

FKM: Ozono, oxígeno, ácidos, gas, aceite y carburantes.



GRIP FIRE FENCE

CARCASA EN ACERO INOXIDABLE

| diámetro exterior |  PN (bar) |  PN (bar) | Ref. EPDM | € EPDM | Ref. NBR | € NBR | Ref. FKM | € FKM |
|-------------------|--|--|-----------|--------|----------|--------|----------|--------|
| 25,0 | 64,0 | 16,0 | G20044 | 187,41 | G20042 | 187,41 | G20045 | 253,14 |
| 26,9 | 58,0 | 16,0 | G20007 | 188,73 | G20008 | 188,73 | G20013 | 253,14 |
| 28,0 | 50,0 | 16,0 | G20028 | 188,73 | G20029 | 188,73 | G20030 | 255,03 |
| 30,0 | 42,0 | 16,0 | G20056 | 188,73 | G20057 | 188,73 | G20058 | 255,03 |
| 33,7 | 39,0 | 16,0 | G20108 | 188,73 | G20109 | 188,73 | G20114 | 255,03 |
| 35,0 | 37,0 | 16,0 | G20127 | 190,78 | G20128 | 190,78 | G20129 | 256,92 |
| 38,0 | 36,0 | 16,0 | G20157 | 190,78 | G20158 | 190,78 | G20165 | 258,83 |
| 40,0 | 35,0 | 16,0 | G20178 | 190,78 | G20179 | 190,78 | G20180 | 260,71 |
| 42,4 | 33,0 | 16,0 | G20209 | 190,78 | G20210 | 190,78 | G20214 | 262,61 |
| 44,5 | 30,0 | 16,0 | G20258 | 190,78 | G20259 | 190,78 | G20263 | 262,61 |
| 48,3 | 28,0 | 16,0 | G20310 | 192,67 | G20311 | 192,67 | G20318 | 264,47 |
| 54,0 | 24,0 | 16,0 | G20358 | 196,48 | G20359 | 196,48 | G20362 | 266,37 |
| 57,0 | 23,0 | 16,0 | G20408 | 196,48 | G20409 | 196,48 | G20412 | 270,15 |
| 60,3 | 23,0 | 16,0 | G20464 | 200,24 | G20465 | 200,24 | G20448 | 270,15 |
| 63,0 | 23,0 | 16,0 | G20428 | 205,92 | G20429 | 205,92 | G20430 | 277,69 |
| 66,6 | 22,0 | 16,0 | G20474 | 213,47 | G20475 | 213,47 | G20477 | 287,15 |
| 70,0 | 22,0 | 16,0 | G20492 | 221,02 | G20493 | 221,02 | G20495 | 300,37 |
| 73,0 | 21,0 | 16,0 | G20508 | 228,58 | G20509 | 228,58 | G20510 | 304,14 |
| 76,1 | 35,0 | 16,0 | G20567 | 236,13 | G20568 | 236,13 | G20581 | 307,92 |
| 79,5 | 32,0 | 16,0 | G20574 | 241,82 | G20575 | 241,82 | G20582 | 313,59 |
| 84,0 | 29,0 | 16,0 | G20607 | 247,47 | G20608 | 247,47 | G20613 | 319,25 |
| 88,9 | 26,0 | 16,0 | G20664 | 249,36 | G20665 | 249,36 | G20676 | 319,25 |
| 95,0 | 24,0 | 16,0 | G20679 | 256,92 | G20680 | 256,92 | G20681 | 324,93 |
| 98,0 | 24,0 | 16,0 | G20693 | 260,71 | G20694 | 260,71 | G20695 | 328,71 |
| 100,6 | 23,0 | 16,0 | G20704 | 262,61 | G20705 | 262,61 | G20707 | 330,61 |
| 101,6 | 23,0 | 16,0 | G20757 | 264,47 | G20758 | 264,47 | G20759 | 332,47 |
| 104,0 | 23,0 | 16,0 | G20806 | 270,15 | G20807 | 270,15 | G20812 | 338,15 |
| 104,8 | 23,0 | 16,0 | G20829 | 270,15 | G20830 | 270,15 | G20831 | 338,15 |
| 108,0 | 22,0 | 16,0 | G20863 | 272,03 | G20864 | 272,03 | G20866 | 340,04 |
| 114,3 | 22,0 | 16,0 | G20913 | 283,37 | G20914 | 283,37 | G20925 | 345,71 |

Acoplamiento para tubos metálicos
con anclaje axial y con protección al fuego.
Acoplamiento para alta presión de alta calidad.



Junta: EPDM: -20°C hasta +100°C NBR: -20°C hasta +80°C FKM: -20°C hasta +180°C
Fluido: EPDM: Todas las calidades de agua, aguas residuales, aire, sólidos y diversos productos químicos.
NBR: Agua, gas, aceite, combustible y otros hidrocarburos.
FKM: Ozono, oxígeno, ácidos, gas, aceite y carburantes.

Continúa en la página siguiente...



GRIP FIRE FENCE

CARCASA EN ACERO INOXIDABLE

| diámetro exterior |  PN (bar) |  PN (bar) | Ref. EPDM | € EPDM | Ref. NBR | € NBR | Ref. FKM | € FKM |
|-------------------|--|--|-----------|----------|----------|----------|----------|----------|
| 118,0 | 22,0 | 16,0 | G20933 | 290,96 | G20934 | 290,96 | G20935 | 349,49 |
| 125,0 | 21,0 | 16,0 | G20943 | 353,28 | G20944 | 353,28 | G20945 | 364,62 |
| 127,0 | 21,0 | 16,0 | G20954 | 368,36 | G20955 | 368,36 | G20958 | 387,29 |
| 129,0 | 21,0 | 16,0 | G21004 | 383,48 | G21005 | 383,48 | G21007 | 409,97 |
| 130,2 | 21,0 | 16,0 | G21054 | 391,06 | G21055 | 391,06 | G21056 | 426,96 |
| 133,0 | 21,0 | 16,0 | G21106 | 409,97 | G21107 | 409,97 | G21113 | 459,08 |
| 139,7 | 20,0 | 16,0 | G21156 | 457,16 | G21157 | 457,16 | G21169 | 534,62 |
| 141,3 | 20,0 | 16,0 | G21206 | 468,49 | G21207 | 468,49 | G21209 | 555,43 |
| 144,0 | 20,0 | 16,0 | G21228 | 474,19 | G21229 | 474,19 | G21230 | 572,40 |
| 154,0 | 18,0 | 16,0 | G21256 | 493,04 | G21257 | 493,04 | G21264 | 638,53 |
| 159,0 | 18,0 | 16,0 | G21306 | 498,75 | G21307 | 498,75 | G21312 | 666,86 |
| 165,0 | 16,0 | 16,0 | G21329 | 515,73 | G21330 | 515,73 | G21332 | 712,22 |
| 168,3 | 16,0 | 16,0 | G21358 | 525,18 | G21359 | 525,18 | G21377 | 736,74 |
| 219,1 | 16,0 | 10,0 | 21409 | 971,00 | 21410 | 971,00 | 21418 | 1.122,12 |
| 180,0 | 16,0 | 10,0 | 24957 | 1.348,85 | 24958 | 1.348,85 | 24960 | 1.388,50 |
| 193,7 | 16,0 | 10,0 | 24997 | 1.367,73 | 25008 | 1.367,73 | 24999 | 1.409,29 |
| 200,0 | 15,0 | 10,0 | 25018 | 1.377,19 | 25019 | 1.377,19 | 25021 | 1.418,73 |
| 204,0 | 14,0 | 10,0 | 25044 | 1.384,74 | 25045 | 1.384,74 | 25047 | 1.430,08 |
| 206,0 | 14,0 | 5,5 | 25076 | 1.384,74 | 25077 | 1.384,74 | 25079 | 1.430,08 |
| 244,5 | 9,0 | 5,5 | 25096 | 1.441,40 | 25097 | 1.441,40 | 25099 | 1.490,55 |
| 250,0 | 9,0 | 5,5 | 25116 | 1.450,87 | 25117 | 1.450,87 | 25119 | 1.507,50 |
| 254,0 | 9,0 | 5,5 | 25133 | 1.456,52 | 25134 | 1.456,52 | 25136 | 1.516,98 |
| 256,0 | 9,0 | 5,5 | 25146 | 1.456,52 | 25147 | 1.456,52 | 25149 | 1.516,98 |
| 267,0 | 8,0 | 5,0 | 25159 | 1.475,40 | 25158 | 1.475,40 | 25163 | 1.552,87 |
| 273,0 | 7,0 | 4,0 | 25212 | 1.479,19 | 25211 | 1.479,19 | 25196 | 1.564,18 |
| 306,0 | 6,0 | 3,0 | 25268 | 1.509,42 | 25269 | 1.509,42 | 25271 | 1.634,12 |
| 323,9 | 5,0 | 3,0 | 25312 | 1.552,87 | 25314 | 1.552,87 | 25297 | 1.698,32 |
| 355,6 | 10,0 | 2,5 | 25359 | 1.630,32 | 25511 | 1.630,32 | 25349 | 2.098,84 |
| 406,4 | 7,0 | 2,0 | 25415 | 1.745,56 | 25412 | 1.745,56 | 25397 | 2.248,06 |

Acoplamiento para tubos metálicos con anclaje axial.

Acoplamiento para alta presión de alta calidad.

Junta: EPDM: -20°C hasta +100°C NBR: -20°C hasta +80°C FKM: -20°C hasta +180°C

Fluido: EPDM: Todas las calidades de agua, aguas residuales, aire, sólidos y diversos productos químicos.

NBR: Agua, gas, aceite, combustible y otros hidrocarburos.

FKM: Ozono, oxígeno, ácidos, gas, aceite y carburantes.



GRIP FIRE FENCE

CARCASA EN ACERO GALVANIZADO

| diámetro exterior | PN (bar) | PN (bar) | Ref. EPDM | € EPDM | Ref. NBR | € NBR | Ref. FKM | € FKM |
|-------------------|----------|----------|-----------|----------|----------|----------|----------|----------|
| 180,0 | 16,0 | 10,0 | 24956 | 1.290,29 | 24961 | 1.290,29 | 24959 | 1.331,82 |
| 193,7 | 16,0 | 10,0 | 24995 | 1.309,15 | 24996 | 1.309,15 | 24998 | 1.350,76 |
| 200,0 | 15,0 | 10,0 | 25016 | 1.318,64 | 25017 | 1.318,64 | 25020 | 1.360,16 |
| 204,0 | 14,0 | 10,0 | 25042 | 1.326,20 | 25043 | 1.326,20 | 25046 | 1.371,50 |
| 206,0 | 14,0 | 5,5 | 25073 | 1.326,20 | 25074 | 1.326,20 | 25078 | 1.371,50 |
| 244,5 | 9,0 | 5,5 | 25094 | 1.382,85 | 25095 | 1.382,85 | 25098 | 1.431,96 |
| 250,0 | 9,0 | 5,5 | 25108 | 1.392,29 | 25109 | 1.392,29 | 25118 | 1.448,97 |
| 254,0 | 9,0 | 5,5 | 25123 | 1.399,86 | 25124 | 1.399,86 | 25135 | 1.460,31 |
| 256,0 | 9,0 | 5,5 | 25138 | 1.399,86 | 25139 | 1.399,86 | 25148 | 1.460,31 |
| 267,0 | 8,0 | 5,0 | 25160 | 1.416,85 | 25161 | 1.416,85 | 25162 | 1.494,33 |
| 273,0 | 7,0 | 4,0 | 25193 | 1.420,65 | 25194 | 1.420,65 | 25195 | 1.505,65 |
| 306,0 | 6,0 | 3,0 | 25266 | 1.450,87 | 25267 | 1.450,87 | 25270 | 1.575,56 |
| 323,9 | 5,0 | 3,0 | 25294 | 1.494,33 | 25295 | 1.494,33 | 25296 | 1.639,77 |
| 355,6 | 10,0 | 2,5 | 25346 | 1.571,73 | 25347 | 1.571,73 | 25348 | 2.021,36 |
| 406,4 | 7,0 | 2,0 | 25394 | 1.687,02 | 25395 | 1.687,02 | 25396 | 2.168,72 |

Acoplamiento para tubos metálicos con anclaje axial y con protección al fuego. Acoplamientos para alta presión de alta calidad.

Junta: EPDM: -20°C hasta +100°C NBR: -20°C hasta +80°C FKM: -20°C hasta +180°C
Fluido: EPDM: Todas las calidades de agua, aguas residuales, aire, sólidos y diversos productos químicos.
 NBR: Agua, gas, aceite, combustible y otros hidrocarburos.
 FKM: Ozono, oxígeno, ácidos, gas, aceite y carburantes.



COMBI-GRIP

| diámetro exterior | PN (bar) | CARCASA EN ACERO GALVANIZADO | | | | CARCASA EN ACERO INOXIDABLE | | | |
|-------------------|----------|------------------------------|----------|----------|--------|-----------------------------|----------|----------|----------|
| | | Ref. EPDM | € EPDM | Ref. NBR | € NBR | Ref. EPDM | € EPDM | Ref. NBR | € NBR |
| 40,0 / 38,0 | 16,0 | 9130 | 206,19 | 9132 | 206,19 | 14800 | 238,25 | 14801 | 238,25 |
| 40,0 / 42,4 | 16,0 | 9120 | 206,19 | 9123 | 206,19 | 104274 | 238,25 | 14802 | 238,25 |
| 50,0 / 48,3 | 16,0 | 6768 | 211,62 | 6769 | 211,62 | 100602 | 244,75 | 104782 | 244,75 |
| 63,0 / 60,3 | 16,0 | 9114 | 218,73 | 9113 | 218,73 | 9399 | 251,23 | 9400 | 251,23 |
| 75,0 / 76,1 | 16,0 | 94 | 257,74 | 98 | 257,74 | 100605 | 298,89 | 101302 | 298,89 |
| 90,0 / 88,9 | 16,0 | 91 | 279,39 | 422 | 279,39 | 40458 | 318,40 | 420 | 318,40 |
| 110,0 / 108,0 | 16,0 | 424 | 311,89 | 426 | 311,89 | 101504 | 353,03 | 104793 | 353,03 |
| 110,0 / 114,3 | 16,0 | 14954 | 394,18 | 14956 | 394,18 | 100606 | 444,04 | 101041 | 444,04 |
| 114,3 / 114,3 | 16,0 | 428 | 327,06 | 430 | 327,06 | 442 | 368,21 | 443 | 368,21 |
| 140,0 / 139,7 | 16,0 | 432 | 506,81 | 434 | 506,81 | 40500 | 571,81 | 40501 | 571,81 |
| 160,0 / 159,0 | 16,0 | 436 | 563,13 | 438 | 563,13 | 40502 | 628,13 | 40503 | 628,13 |
| 160,0 / 168,3 | 16,0 | | | | | 102727 | 628,14 | 102726 | 628,14 |
| 200,0 / 206,0 | 16,0 | 102704 | 732,06 | 102705 | 732,06 | 101839 | 801,41 | 102196 | 801,41 |
| 225,0 / 219,1 | 10,0 | 102707 | 773,23 | 102708 | 773,23 | 102706 | 844,67 | 102709 | 844,67 |
| 225,0 / 229,0 | 10,0 | 102881 | 773,23 | 102880 | 773,23 | 102035 | 844,67 | 102879 | 844,67 |
| 250,0 / 256,0 | 10,0 | 102715 | 818,71 | 102713 | 818,71 | 102225 | 888,03 | 102712 | 888,03 |
| 315,0 / 323,9 | 10,0 | 102714 | 935,69 | 102716 | 935,69 | 102569 | 1.005,01 | 102717 | 1.005,01 |
| 355,0 / 355,6 | 6,0 | 102721 | 1.009,32 | 102720 | | 102719 | 1.078,65 | 102718 | 1.078,65 |

Acoplamiento para transiciones

de tubos plásticos a metálicos con anclaje axial.

En tubos plásticos es necesario incorporar el anillo de refuerzo "stiffening ring".

Junta: EPDM: -20°C hasta +100°C NBR: -20°C hasta +80°C

Fluido: EPDM: Todas las calidades de agua, aguas residuales, aire, sólidos y diversos productos químicos.

NBR: Agua, gas, aceite, combustible y otros hidrocarburos.



FLEX 1

CARCASA EN ACERO GALVANIZADO

| diámetro exterior | PN (bar) | PN (bar) | Ref. EPDM | € EPDM | Ref. NBR | € NBR | Ref. FKM (1) | € FKM |
|-------------------|----------|----------|-----------|--------|----------|--------|--------------|--------|
| 48,3 | 25,0 | 16,0 | 30001 | 88,81 | 30003 | 88,81 | | |
| 54,0 | 25,0 | 16,0 | 30051 | 90,96 | 30053 | 90,96 | | |
| 57,0 | 25,0 | 16,0 | 30101 | 91,86 | 30103 | 91,86 | | |
| 60,3 | 25,0 | 16,0 | 30151 | 94,01 | 30153 | 94,01 | 30162 | 178,49 |
| 70,0 | 25,0 | 16,0 | 30194 | 106,56 | 30191 | 106,56 | 30196 | 207,30 |
| 73,0 | 25,0 | 16,0 | 30201 | 107,45 | 30203 | 107,45 | 30208 | 209,69 |
| 76,1 | 25,0 | 16,0 | 30251 | 108,27 | 30253 | 108,27 | 30258 | 212,06 |
| 80,0 | 25,0 | 16,0 | | | | | 102951 | 214,65 |
| 84,0 | 25,0 | 16,0 | 30301 | 110,67 | 30303 | 110,67 | 30314 | 216,39 |
| 88,9 | 25,0 | 16,0 | 30351 | 112,19 | 30353 | 112,19 | 30364 | 218,73 |
| 100,6 | 25,0 | 16,0 | 30401 | 115,44 | 30403 | 115,44 | 30411 | 223,09 |
| 101,6 | 25,0 | 16,0 | 30451 | 115,66 | 30453 | 115,66 | 30460 | 223,09 |
| 104,0 | 20,0 | 16,0 | 30501 | 116,10 | 30503 | 116,10 | 30511 | 225,26 |
| 104,8 | 20,0 | 16,0 | 30551 | 116,54 | 30553 | 116,54 | 30559 | 225,26 |
| 108,0 | 20,0 | 16,0 | 30601 | 117,38 | 30603 | 117,38 | 30613 | 227,43 |
| 114,3 | 20,0 | 16,0 | 30651 | 118,48 | 30653 | 118,48 | 30658 | 227,43 |
| 127,0 | 20,0 | 16,0 | 30676 | 154,66 | 30678 | 154,66 | 30679 | 272,93 |
| 129,0 | 20,0 | 16,0 | 30701 | 155,95 | 30703 | 155,95 | 30715 | 275,07 |
| 130,2 | 20,0 | 16,0 | 30751 | 156,58 | 30753 | 156,58 | 30754 | 277,25 |
| 133,0 | 16,0 | 16,0 | 30801 | 158,54 | 30803 | 158,54 | 30812 | 279,39 |
| 139,7 | 16,0 | 16,0 | 30851 | 160,91 | 30853 | 160,91 | 30867 | 290,24 |
| 141,3 | 16,0 | 16,0 | 30901 | 161,99 | 30903 | 161,99 | 30909 | 292,39 |
| 154,0 | 16,0 | 16,0 | 30951 | 166,36 | 30953 | 166,36 | 30963 | 311,89 |
| 159,0 | 16,0 | 16,0 | 31001 | 168,92 | 31003 | 168,92 | 31016 | 318,40 |
| 168,3 | 16,0 | 16,0 | 31051 | 173,07 | 31053 | 173,07 | 31075 | 331,39 |

Acoplamiento para tubos de cualquier material sin anclaje axial.

Acoplamiento de unión y compensador todo en uno.

(1) acoplamiento con anillo interior en acero inoxidable incorporado.

Junta: EPDM: -20°C hasta +100°C NBR: -20°C hasta +80°C FKM: -20°C hasta +180°C

Fluido: EPDM: Todas las calidades de agua, aguas residuales, aire, sólidos y diversos productos químicos.



NBR: Agua, gas, aceite, combustible y otros hidrocarburos.

FKM: Ozono, oxígeno, ácidos, gas, aceite y carburantes.



FLEX 1

CARCASA EN ACERO INOXIDABLE

| diámetro exterior |  PN (bar) |  PN (bar) | Ref. EPDM | € EPDM | Ref. NBR | € NBR | Ref. FKM(1) | € FKM |
|-------------------|--|--|-----------|--------|----------|--------|-------------|--------|
| 48,3 | 25,0 | 16,0 | 30000 | 122,80 | 30002 | 122,80 | | |
| 54,0 | 25,0 | 16,0 | 30050 | 125,64 | 30052 | 125,64 | | |
| 57,0 | 25,0 | 16,0 | 30100 | 126,69 | 30102 | 126,69 | | |
| 60,3 | 25,0 | 16,0 | 30150 | 128,01 | 30152 | 128,01 | 30166 | 212,06 |
| 70,0 | 25,0 | 16,0 | 30193 | 141,43 | 30195 | 141,43 | 30197 | 242,57 |
| 73,0 | 25,0 | 16,0 | 30200 | 142,10 | 30202 | 142,10 | 30216 | 244,74 |
| 76,1 | 25,0 | 16,0 | 30250 | 142,74 | 30252 | 142,74 | 30266 | 246,89 |
| 80,0 | 25,0 | 16,0 | 30318 | 144,47 | | | | |
| 84,0 | 24,0 | 16,0 | 30300 | 145,55 | 30302 | 145,55 | 30315 | 251,23 |
| 88,9 | 24,0 | 16,0 | 30350 | 146,86 | 30352 | 146,86 | 30366 | 253,42 |
| 100,6 | 23,0 | 16,0 | 30400 | 150,12 | 30402 | 150,12 | 30412 | 257,74 |
| 101,6 | 23,0 | 16,0 | 30450 | 150,30 | 30452 | 150,30 | 30461 | 257,74 |
| 104,0 | 22,0 | 16,0 | 30500 | 150,76 | 30502 | 150,76 | 30512 | 262,06 |
| 104,8 | 22,0 | 16,0 | 30550 | 150,95 | 30552 | 150,95 | 30560 | 262,06 |
| 108,0 | 22,0 | 16,0 | 30600 | 152,70 | 30602 | 152,70 | 30614 | 264,28 |
| 114,3 | 21,0 | 16,0 | 30650 | 153,78 | 30652 | 153,78 | 30666 | 264,28 |
| 127,0 | 19,0 | 16,0 | 30675 | 199,03 | 30677 | 199,03 | 30680 | 316,21 |
| 129,0 | 18,0 | 16,0 | 30700 | 200,32 | 30702 | 200,32 | 30716 | 318,40 |
| 130,2 | 18,0 | 16,0 | 30750 | 201,22 | 30752 | 201,22 | 30755 | 320,55 |
| 133,0 | 16,0 | 16,0 | 30800 | 202,50 | 30802 | 202,50 | 30813 | 322,73 |
| 139,7 | 16,0 | 16,0 | 30850 | 205,75 | 30852 | 205,75 | 30866 | 335,70 |
| 141,3 | 16,0 | 16,0 | 30900 | 206,19 | 30902 | 206,19 | 30908 | 337,90 |
| 154,0 | 16,0 | 16,0 | 30950 | 211,38 | 30952 | 211,38 | 30964 | 357,37 |
| 159,0 | 16,0 | 16,0 | 31000 | 213,76 | 31002 | 213,76 | 31017 | 363,88 |
| 168,3 | 16,0 | 16,0 | 31050 | 218,73 | 31052 | 218,73 | 31074 | 376,87 |

Acoplamiento para tubos de cualquier material sin anclaje axial.

Acoplamiento de unión y compensador todo en uno.

(1) acoplamiento con anillo interior en acero inoxidable incorporado.

Junta: EPDM: -20°C hasta +100°C NBR: -20°C hasta +80°C FKM: -20°C hasta +180°C

Fluido: EPDM: Todas las calidades de agua, aguas residuales, aire, sólidos y diversos productos químicos.

NBR: Agua, gas, aceite, combustible y otros hidrocarburos.

FKM: Ozono, oxígeno, ácidos, gas, aceite y carburantes.



FLEX 2 PN 2,5



PN Consultar

| desde Ø exterior | hasta Ø exterior | Ref. EPDM | W1 CARCASA GALVANIZADA. CIERRES GALVANIZADOS | | | W2 CARCASA EN ACERO INOX. CIERRES GALVANIZADOS | | | W5 CARCASA EN ACERO INOX. CIERRES EN ACERO INOX. | | |
|------------------|------------------|-----------|--|-------|-----------|--|--------|-----------|--|--------|-----------|
| | | | € EPDM | € NBR | € FKM (1) | € EPDM | € NBR | € FKM (1) | € EPDM | € NBR | € FKM (1) |
| 172,0 | 199,0 | | | | | 442,85 | 442,85 | 651,11 | 527,19 | 527,19 | 735,46 |
| 200,0 | 224,0 | | | | | 456,04 | 456,04 | 698,53 | 540,40 | 540,40 | 782,89 |
| 225,0 | 249,0 | | | | | 466,58 | 466,58 | 751,26 | 550,95 | 550,95 | 835,62 |
| 250,0 | 274,0 | | | | | 482,39 | 482,39 | 806,63 | 566,75 | 566,75 | 890,98 |

Continúa en la página siguiente...

| desde Ø exterior | hasta Ø exterior | Ref. EPDM | W1 CARCASA GALVANIZADA. CIERRES GALVANIZADOS | | | W2 CARCASA EN ACERO INOX. CIERRES GALVANIZADOS | | | W5 CARCASA EN ACERO INOX. CIERRES EN ACERO INOX. | | |
|------------------|------------------|-------------|---|----------|-----------|---|----------|-----------|---|----------|-----------|
| | | | € EPDM | € NBR | € FKM (1) | € EPDM | € NBR | € FKM (1) | € EPDM | € NBR | € FKM (1) |
| 275,0 | 299,0 | F2020275W1E | 801,35 | 801,35 | 1.133,48 | 490,29 | 490,29 | 861,96 | 574,63 | 574,63 | 946,32 |
| 300,0 | 324,0 | F2020300W1E | 814,53 | 814,53 | 1.191,46 | 508,75 | 508,75 | 912,05 | 593,08 | 593,08 | 996,39 |
| 325,0 | 349,0 | F2020325W1E | 827,69 | 827,69 | 1.254,72 | 519,29 | 519,29 | 967,40 | 603,64 | 603,64 | 1.051,77 |
| 350,0 | 374,0 | F2020350W1E | 840,89 | 840,89 | 1.307,46 | 532,47 | 532,47 | 1.020,14 | 616,84 | 616,84 | 1.104,50 |
| 375,0 | 399,0 | F2020375W1E | 854,09 | 854,09 | 1.370,71 | 543,02 | 543,02 | 1.072,82 | 627,39 | 627,39 | 1.157,19 |
| 400,0 | 424,0 | F2020400W1E | 872,51 | 872,51 | 1.433,96 | 553,54 | 553,54 | 1.125,57 | 637,90 | 637,90 | 1.209,92 |
| 425,0 | 449,0 | F2020425W1E | 885,69 | 885,69 | 1.484,08 | 569,37 | 569,37 | 1.180,93 | 653,71 | 653,71 | 1.265,27 |
| 450,0 | 474,0 | F2020450W1E | 898,89 | 898,89 | 1.539,42 | 585,21 | 585,21 | 1.236,28 | 669,54 | 669,54 | 1.320,64 |
| 475,0 | 499,0 | F2020475W1E | 914,71 | 914,71 | 1.594,75 | 603,64 | 603,64 | 1.286,38 | 688,00 | 688,00 | 1.370,71 |
| 500,0 | 524,0 | F2020500W1E | 925,24 | 925,24 | 1.647,51 | 619,44 | 619,44 | 1.341,70 | 703,79 | 703,79 | 1.426,06 |
| 525,0 | 549,0 | F2020525W1E | 946,32 | 946,32 | 1.708,13 | 635,29 | 635,29 | 1.394,44 | 719,65 | 719,65 | 1.478,79 |
| 550,0 | 574,0 | F2020550W1E | 972,67 | 972,67 | 1.776,67 | 648,45 | 648,45 | 1.449,80 | 732,80 | 732,80 | 1.534,15 |
| 575,0 | 599,0 | F2020575W1E | 993,78 | 993,78 | 1.834,65 | 666,91 | 666,91 | 1.502,54 | 751,26 | 751,26 | 1.586,89 |
| 600,0 | 624,0 | F2020600W1E | 1.051,77 | 1.051,77 | 1.892,66 | 785,53 | 785,53 | 1.631,69 | 869,89 | 869,89 | 1.716,04 |
| 625,0 | 649,0 | F2020625W1E | 1.072,82 | 1.072,82 | 1.963,81 | 793,42 | 793,42 | 1.689,66 | 877,78 | 877,78 | 1.774,02 |
| 650,0 | 674,0 | F2020650W1E | 1.093,97 | 1.093,97 | 2.021,82 | 811,89 | 811,89 | 1.742,40 | 896,27 | 896,27 | 1.826,76 |
| 675,0 | 699,0 | F2020675W1E | 1.115,03 | 1.115,03 | 2.079,81 | 832,95 | 832,95 | 1.797,76 | 917,32 | 917,32 | 1.882,10 |
| 700,0 | 724,0 | F2020700W1E | 1.141,39 | 1.141,39 | 2.143,07 | 851,45 | 851,45 | 1.850,50 | 935,79 | 935,79 | 1.934,86 |
| 725,0 | 749,0 | F2020725W1E | 1.162,46 | 1.162,46 | 2.198,43 | 877,78 | 877,78 | 1.905,83 | 962,14 | 962,14 | 1.990,20 |
| 750,0 | 799,0 | F2020750W1E | 1.180,93 | 1.180,93 | 2.230,05 | 1.038,58 | 1.038,58 | 1.990,20 | 1.122,96 | 1.122,96 | 2.074,55 |
| 800,0 | 849,0 | F2020800W1E | 1.228,40 | 1.228,40 | 2.288,07 | 1.075,50 | 1.075,50 | 2.098,23 | 1.159,85 | 1.159,85 | 2.182,59 |
| 850,0 | 899,0 | F2020850W1E | 1.267,93 | 1.267,93 | 2.346,03 | 1.112,36 | 1.112,36 | 2.206,33 | 1.196,75 | 1.196,75 | 2.290,68 |
| 900,0 | 949,0 | F2020900W1E | 1.315,37 | 1.315,37 | 2.464,66 | 1.154,57 | 1.154,57 | 2.319,68 | 1.238,94 | 1.238,94 | 2.404,04 |
| 950,0 | 999,0 | F2020950W1E | 1.357,55 | 1.357,55 | 2.588,55 | 1.191,46 | 1.191,46 | 2.427,78 | 1.275,81 | 1.275,81 | 2.512,13 |
| 1.000,0 | 1.049,0 | F2021000W1E | 1.397,10 | 1.397,10 | 2.701,91 | 1.233,66 | 1.233,66 | 2.535,82 | 1.318,01 | 1.318,01 | 2.620,17 |
| 1.050,0 | 1.099,0 | F2021050W1E | 1.447,17 | 1.447,17 | 2.809,96 | 1.283,72 | 1.283,72 | 2.643,92 | 1.368,10 | 1.368,10 | 2.728,27 |
| 1.100,0 | 1.149,0 | F2021100W1E | 1.486,70 | 1.486,70 | 2.904,86 | 1.339,10 | 1.339,10 | 2.754,61 | 1.423,45 | 1.423,45 | 2.838,96 |
| 1.150,0 | 1.199,0 | F2021150W1E | 1.531,53 | 1.531,53 | 3.007,68 | 1.391,82 | 1.391,82 | 2.865,32 | 1.476,14 | 1.476,14 | 2.949,65 |
| 1.200,0 | 1.249,0 | F2021200W1E | 1.576,35 | 1.576,35 | 3.113,11 | 1.444,52 | 1.444,52 | 2.973,39 | 1.528,89 | 1.528,89 | 3.057,74 |
| 1.250,0 | 1.299,0 | F2021250W1E | 1.623,78 | 1.623,78 | 3.221,19 | 1.497,28 | 1.497,28 | 3.084,10 | 1.581,62 | 1.581,62 | 3.168,48 |
| 1.300,0 | 1.349,0 | F2021300W1E | 1.668,59 | 1.668,59 | 3.326,62 | 1.547,35 | 1.547,35 | 3.192,20 | 1.631,69 | 1.631,69 | 3.276,55 |
| 1.350,0 | 1.399,0 | F2021350W1E | 1.716,04 | 1.716,04 | 3.432,07 | 1.600,04 | 1.600,04 | 3.300,31 | 1.684,39 | 1.684,39 | 3.384,65 |
| 1.400,0 | 1.449,0 | F2021400W1E | 1.760,85 | 1.760,85 | 3.540,15 | 1.650,11 | 1.650,11 | 3.410,97 | 1.734,46 | 1.734,46 | 3.495,33 |
| 1.450,0 | 1.499,0 | F2021450W1E | 1.808,30 | 1.808,30 | 3.645,58 | 1.702,84 | 1.702,84 | 3.521,67 | 1.787,20 | 1.787,20 | 3.606,06 |
| 1.500,0 | 1.549,0 | F2021500W1E | 1.853,09 | 1.853,09 | 3.751,01 | 2.237,95 | 2.237,95 | 4.135,89 | 2.327,57 | 2.327,57 | 4.225,52 |
| 1.550,0 | 1.600,0 | F2021550W1E | 1.900,57 | 1.900,57 | 3.859,11 | 2.301,22 | 2.301,22 | 4.259,81 | 2.390,84 | 2.390,84 | 4.349,44 |
| 1.600,0 | 1.649,0 | F2021600W1E | 1.947,98 | 1.947,98 | 3.964,56 | 2.367,10 | 2.367,10 | 4.383,67 | 2.456,73 | 2.456,73 | 4.473,29 |
| 1.650,0 | 1.699,0 | F2021650W1E | 1.992,81 | 1.992,81 | 4.069,97 | 2.433,04 | 2.433,04 | 4.510,21 | 2.522,68 | 2.522,68 | 4.599,83 |
| 1.700,0 | 1.749,0 | F2021700W1E | 2.040,27 | 2.040,27 | 4.175,44 | 2.498,93 | 2.498,93 | 4.634,09 | 2.588,55 | 2.588,55 | 4.723,71 |
| 1.750,0 | 1.799,0 | F2021750W1E | 2.085,09 | 2.085,09 | 4.280,87 | 2.562,22 | 2.562,22 | 4.760,62 | 2.651,86 | 2.651,86 | 4.850,25 |
| 1.800,0 | 1.849,0 | F2021800W1E | 2.132,50 | 2.132,50 | 4.386,30 | 2.628,10 | 2.628,10 | 4.884,51 | 2.717,73 | 2.717,73 | 4.974,14 |
| 1.850,0 | 1.899,0 | F2021850W1E | 2.177,32 | 2.177,32 | 4.494,38 | 2.693,98 | 2.693,98 | 5.008,41 | 2.783,62 | 2.783,62 | 5.098,03 |
| 1.900,0 | 1.949,0 | F2021900W1E | 2.224,79 | 2.224,79 | 4.599,83 | 2.757,28 | 2.757,28 | 5.134,93 | 2.846,90 | 2.846,90 | 5.224,56 |
| 1.950,0 | 1.999,0 | F2021950W1E | 2.269,60 | 2.269,60 | 4.705,27 | 2.823,16 | 2.823,16 | 5.258,82 | 2.912,79 | 2.912,79 | 5.348,46 |
| 2.000,0 | 2.032,0 | F2022000W1E | 2.317,04 | 2.317,04 | 4.810,71 | 2.889,05 | 2.889,05 | 5.382,69 | 2.978,65 | 2.978,65 | 5.472,32 |

Acoplamiento para tubos de cualquier material sin anclaje axial.

Acoplamiento de unión y compensador todo en uno.

Código W1 en NBR termina W1N
Código W1 en FKM termina W1F

Código W2 en EPDM termina W2E
Código W2 en NBR termina W2N
Código W2 en FKM termina W2F

Código W5 en EPDM termina W5E
Código W5 en NBR termina W5N
Código W5 en FKM termina W5F

(1) Los acoplamientos con la junta en FKM llevan incluido un anillo interior en acero inoxidable.

En caso de pedido indicar el diámetro exterior exacto.

Junta: EPDM: -20°C hasta +100°C NBR: -20°C hasta +80°C FKM: -20°C hasta +180°C

Fluido: EPDM: Todas las calidades de agua, aguas residuales, aire, sólidos y diversos productos químicos.

NBR: Agua, gas, aceite, combustible y otros hidrocarburos.

FKM: Ozono, oxígeno, ácidos, gas, aceite y carburantes.

Especificar 1 o 2 cierres

FLEX 2 PN 6  PN  Consultar

| desde Ø exterior | hasta Ø exterior | Ref. EPDM | W1 CARCASA GALVANIZADA. CIERRES GALVANIZADOS | | | W2 CARCASA EN ACERO INOX. CIERRES GALVANIZADOS | | | W5 CARCASA EN ACERO INOX. CIERRES EN ACERO INOX. | | |
|------------------|------------------|-------------|---|----------|-----------|---|----------|-----------|---|----------|-----------|
| | | | € EPDM | € NBR | € FKM (1) | € EPDM | € NBR | € FKM (1) | € EPDM | € NBR | € FKM (1) |
| 172,0 | 199,0 | | | | | 442,85 | 442,85 | 651,11 | 527,19 | 527,19 | 735,46 |
| 200,0 | 224,0 | | | | | 456,04 | 456,04 | 698,53 | 540,40 | 540,40 | 782,89 |
| 225,0 | 249,0 | | | | | 466,58 | 466,58 | 751,26 | 550,95 | 550,95 | 835,62 |
| 250,0 | 274,0 | | | | | 482,39 | 482,39 | 806,63 | 566,75 | 566,75 | 890,98 |
| 275,0 | 299,0 | F2060275W1E | 801,35 | 801,35 | 1.133,48 | 490,29 | 490,29 | 861,96 | 574,63 | 574,63 | 946,32 |
| 300,0 | 324,0 | F2060300W1E | 814,53 | 814,53 | 1.191,46 | 508,75 | 508,75 | 912,05 | 593,08 | 593,08 | 996,39 |
| 325,0 | 349,0 | F2060325W1E | 827,69 | 827,69 | 1.254,72 | 519,29 | 519,29 | 967,40 | 603,64 | 603,64 | 1.051,77 |
| 350,0 | 374,0 | F2060350W1E | 840,89 | 840,89 | 1.307,46 | 532,47 | 532,47 | 1.020,14 | 616,84 | 616,84 | 1.104,50 |
| 375,0 | 399,0 | F2060375W1E | 854,09 | 854,09 | 1.370,71 | 543,02 | 543,02 | 1.072,82 | 627,39 | 627,39 | 1.157,19 |
| 400,0 | 424,0 | F2060400W1E | 872,51 | 872,51 | 1.433,96 | 553,54 | 553,54 | 1.125,57 | 637,90 | 637,90 | 1.209,92 |
| 425,0 | 449,0 | F2060425W1E | 885,69 | 885,69 | 1.484,08 | 569,37 | 569,37 | 1.180,93 | 653,71 | 653,71 | 1.265,27 |
| 450,0 | 474,0 | F2060450W1E | 898,89 | 898,89 | 1.539,42 | 585,21 | 585,21 | 1.236,28 | 669,54 | 669,54 | 1.320,64 |
| 475,0 | 499,0 | F2060475W1E | 914,71 | 914,71 | 1.594,75 | 603,64 | 603,64 | 1.286,38 | 688,00 | 688,00 | 1.370,71 |
| 500,0 | 524,0 | F2060500W1E | 925,24 | 925,24 | 1.647,51 | 619,44 | 619,44 | 1.341,70 | 703,79 | 703,79 | 1.426,06 |
| 525,0 | 549,0 | F2060525W1E | 946,32 | 946,32 | 1.708,13 | 698,53 | 698,53 | 1.468,26 | 782,89 | 782,89 | 1.552,60 |
| 550,0 | 574,0 | F2060550W1E | 972,67 | 972,67 | 1.776,67 | 714,32 | 714,32 | 1.523,59 | 798,70 | 798,70 | 1.607,95 |
| 575,0 | 599,0 | F2060575W1E | 993,78 | 993,78 | 1.834,65 | 732,80 | 732,80 | 1.576,35 | 817,15 | 817,15 | 1.660,69 |
| 600,0 | 624,0 | F2060600W1E | 1.051,77 | 1.051,77 | 1.892,66 | 1.001,68 | 1.001,68 | 1.842,57 | 1.091,30 | 1.091,30 | 1.932,20 |
| 625,0 | 649,0 | F2060625W1E | 1.072,82 | 1.072,82 | 1.963,81 | 1.014,87 | 1.014,87 | 1.905,83 | 1.104,50 | 1.104,50 | 1.995,46 |
| 650,0 | 674,0 | F2060650W1E | 1.093,97 | 1.093,97 | 2.021,82 | 1.038,58 | 1.038,58 | 1.969,09 | 1.128,22 | 1.128,22 | 2.058,70 |
| 675,0 | 699,0 | F2060675W1E | 1.115,03 | 1.115,03 | 2.079,81 | 1.067,56 | 1.067,56 | 2.029,74 | 1.157,19 | 1.157,19 | 2.119,37 |
| 700,0 | 724,0 | F2060700W1E | 1.141,39 | 1.141,39 | 2.143,07 | 1.091,30 | 1.091,30 | 2.092,96 | 1.180,93 | 1.180,93 | 2.182,59 |
| 725,0 | 749,0 | F2060725W1E | 1.162,46 | 1.162,46 | 2.198,43 | 1.120,30 | 1.120,30 | 2.158,90 | 1.209,92 | 1.209,92 | 2.248,54 |
| 750,0 | 799,0 | F2060750W1E | 1.180,93 | 1.180,93 | 2.230,05 | 1.331,16 | 1.331,16 | 2.253,80 | 1.420,78 | 1.420,78 | 2.343,42 |
| 800,0 | 849,0 | F2060800W1E | 1.228,40 | 1.228,40 | 2.288,07 | 1.375,99 | 1.375,99 | 2.377,69 | 1.465,59 | 1.465,59 | 2.467,31 |

Acoplamiento para tubos de cualquier material sin anclaje axial.

Acoplamiento de unión y compensador todo en uno.

Código W1 en NBR termina W1N
Código W1 en FKM termina W1F

Código W2 en EPDM termina W2E
Código W2 en NBR termina W2N
Código W2 en FKM termina W2F

Código W5 en EPDM termina W5E
Código W5 en NBR termina W5N
Código W5 en FKM termina W5F

Continúa en la página siguiente...

| desde Ø exterior | hasta Ø exterior | Ref. EPDM | W1 CARCASA GALVANIZADA. CIERRES GALVANIZADOS | | | W2 CARCASA EN ACERO INOX. CIERRES GALVANIZADOS | | | W5 CARCASA EN ACERO INOX. CIERRES EN ACERO INOX. | | |
|------------------|------------------|-------------|---|----------|--------------|---|----------|--------------|---|----------|--------------|
| | | | € EPDM | € NBR | € FKM (1) | € EPDM | € NBR | € FKM (1) | € EPDM | € NBR | € FKM (1) |
| 850,0 | 899,0 | F2060850W1E | 1.267,93 | 1.267,93 | 2.346,03 | 1.426,06 | 1.426,06 | 2.504,21 | 1.515,69 | 1.515,69 | 2.593,84 |
| 900,0 | 949,0 | F2060900W1E | 1.315,37 | 1.315,37 | 2.464,66 | 1.476,14 | 1.476,14 | 2.628,10 | 1.565,77 | 1.565,77 | 2.717,73 |
| 950,0 | 999,0 | F2060950W1E | 1.357,55 | 1.357,55 | 2.588,55 | 1.526,27 | 1.526,27 | 2.754,61 | 1.615,89 | 1.615,89 | 2.844,24 |
| 1.000,0 | 1.049,0 | F2061000W1E | 1.397,10 | 1.397,10 | 2.701,91 | 1.576,35 | 1.576,35 | 2.881,17 | 1.665,98 | 1.665,98 | 2.970,79 |
| 1.050,0 | 1.099,0 | F2061050W1E | 1.447,17 | 1.447,17 | 2.809,96 | 1.642,24 | 1.642,24 | 3.005,07 | 1.731,87 | 1.731,87 | 3.094,69 |
| 1.100,0 | 1.149,0 | F2061100W1E | 1.486,70 | 1.486,70 | 2.904,86 | 1.713,39 | 1.713,39 | 3.131,57 | 1.803,03 | 1.803,03 | 3.221,19 |
| 1.150,0 | 1.199,0 | F2061150W1E | 1.531,53 | 1.531,53 | 3.007,68 | 1.781,94 | 1.781,94 | 3.258,09 | 1.871,56 | 1.871,56 | 3.347,71 |
| 1.200,0 | 1.249,0 | F2061200W1E | 1.576,35 | 1.576,35 | 3.113,11 | | | | 3.112,93 | 3.112,93 | 6.028,72 |
| 1.250,0 | 1.299,0 | F2061250W1E | 1.623,78 | 1.623,78 | 3.221,19 | | | | 3.193,58 | 3.193,58 | 6.210,94 |
| 1.300,0 | 1.349,0 | F2061300W1E | 1.668,59 | 1.668,59 | 3.326,62 | | | | 3.277,26 | 3.277,26 | 6.393,17 |
| 1.350,0 | 1.399,0 | F2061350W1E | 1.716,04 | 1.716,04 | 3.432,07 | | | | 3.363,88 | 3.363,88 | 6.578,40 |
| 1.400,0 | 1.449,0 | F2061400W1E | 1.760,85 | 1.760,85 | 3.540,15 | | | | 3.450,52 | 3.450,52 | 6.766,60 |
| 1.450,0 | 1.499,0 | F2061450W1E | 1.808,30 | 1.808,30 | 3.645,58 | | | | 3.543,13 | 3.543,13 | 6.957,79 |
| 1.500,0 | 1.549,0 | F2061500W1E | 1.853,09 | 1.853,09 | 3.751,01 | | | | 3.632,76 | 3.632,76 | 7.152,00 |
| 1.550,0 | 1.600,0 | F2061550W1E | 1.900,57 | 1.900,57 | 3.859,11 | | | | 3.728,37 | 3.728,37 | 7.346,20 |
| 1.600,0 | 1.649,0 | F2061600W1E | 1.947,98 | 1.947,98 | 3.964,56 | | | | 3.823,96 | 3.823,96 | 7.546,34 |
| 1.650,0 | 1.699,0 | F2061650W1E | 1.992,81 | 1.992,81 | 4.069,97 | | | | 3.925,54 | 3.925,54 | 7.746,50 |
| 1.700,0 | 1.749,0 | F2061700W1E | 2.040,27 | 2.040,27 | 4.175,44 | | | | 4.027,08 | 4.027,08 | 7.946,67 |
| 1.750,0 | 1.799,0 | F2061750W1E | 2.085,09 | 2.085,09 | 4.280,87 | | | | 4.134,66 | 4.134,66 | 8.155,78 |
| 1.800,0 | 1.849,0 | F2061800W1E | 2.132,50 | 2.132,50 | 4.386,30 | | | | 4.505,11 | 4.505,11 | 8.624,80 |
| 1.850,0 | 1.899,0 | F2061850W1E | 2.177,32 | 2.177,32 | 4.494,38 | | | | 4.624,59 | 4.624,59 | 8.842,93 |
| 1.900,0 | 1.949,0 | F2061900W1E | 3.197,47 | 3.197,47 | 5.575,17 | | | | 4.747,09 | 4.747,09 | 9.066,98 |
| 1.950,0 | 1.999,0 | F2061950W1E | 3.263,36 | 3.263,36 | 5.699,04 | | | | 4.875,56 | 4.875,56 | 9.297,01 |
| 2.000,0 | 2.032,0 | F2062000W1E | 3.329,30 | 3.329,30 | 5.822,91 | | | | 5.004,00 | 5.004,00 | 9.524,07 |

Código W1 en NBR termina W1N
Código W1 en FKM termina W1F

Código W2 en EPDM termina W2E
Código W2 en NBR termina W2N
Código W2 en FKM termina W2F

Código W5 en EPDM termina W5E
Código W5 en NBR termina W5N
Código W5 en FKM termina W5F

(1) Los acoplamientos con la junta en FKM llevan incluido un anillo interior en acero inoxidable.
En caso de pedido indicar el diámetro exterior exacto.

Junta: EPDM: -20°C hasta +100°C NBR: -20°C hasta +80°C FKM: -20°C hasta +180°C
Fluido: EPDM: Todas las calidades de agua, aguas residuales, aire, sólidos y diversos productos químicos.
NBR: Agua, gas, aceite, combustible y otros hidrocarburos.
FKM: Ozono, oxígeno, ácidos, gas, aceite y carburantes.

Especificar 1 o 2 cierres

FLEX 2 PN 10

 PN
 
 Consultar

| desde Ø exterior | hasta Ø exterior | Ref. EPDM | W1 CARCASA GALVANIZADA. CIERRES GALVANIZADOS | | | W2 CARCASA EN ACERO INOX. CIERRES GALVANIZADOS | | | W5 CARCASA EN ACERO INOX. CIERRES EN ACERO INOX. | | |
|------------------|------------------|-------------|---|----------|-----------|---|----------|-----------|---|----------|-----------|
| | | | € EPDM | € NBR | € FKM (1) | € EPDM | € NBR | € FKM (1) | € EPDM | € NBR | € FKM (1) |
| 172,0 | 199,0 | | | | | 442,85 | 442,85 | 651,11 | 527,19 | 527,19 | 735,46 |
| 200,0 | 224,0 | | | | | 456,04 | 456,04 | 698,53 | 540,40 | 540,40 | 782,89 |
| 225,0 | 249,0 | | | | | 466,58 | 466,58 | 751,26 | 550,95 | 550,95 | 835,62 |
| 250,0 | 274,0 | | | | | 482,39 | 482,39 | 806,63 | 566,75 | 566,75 | 890,98 |
| 275,0 | 299,0 | F2100275W1E | 801,35 | 801,35 | 1.133,48 | 543,02 | 543,02 | 922,60 | 627,39 | 627,39 | 1.006,94 |
| 300,0 | 324,0 | F2100300W1E | 814,53 | 814,53 | 1.191,46 | 556,21 | 556,21 | 977,94 | 640,55 | 640,55 | 1.062,30 |
| 325,0 | 349,0 | F2100325W1E | 827,69 | 827,69 | 1.254,72 | 569,37 | 569,37 | 1.030,67 | 653,71 | 653,71 | 1.115,03 |
| 350,0 | 374,0 | F2100350W1E | 840,89 | 840,89 | 1.307,46 | 748,62 | 748,62 | 1.215,20 | 838,25 | 838,25 | 1.304,81 |
| 375,0 | 399,0 | F2100375W1E | 854,09 | 854,09 | 1.370,71 | 761,80 | 761,80 | 1.278,46 | 851,45 | 851,45 | 1.368,10 |
| 400,0 | 424,0 | F2100400W1E | 872,51 | 872,51 | 1.433,96 | 780,25 | 780,25 | 1.341,70 | 869,89 | 869,89 | 1.431,34 |
| 425,0 | 449,0 | F2100425W1E | 885,69 | 885,69 | 1.484,08 | 803,95 | 803,95 | 1.405,00 | 893,58 | 893,58 | 1.494,60 |
| 450,0 | 474,0 | F2100450W1E | 898,89 | 898,89 | 1.539,42 | 825,09 | 825,09 | 1.465,59 | 914,71 | 914,71 | 1.555,22 |
| 475,0 | 499,0 | F2100475W1E | 914,71 | 914,71 | 1.594,75 | 848,77 | 848,77 | 1.528,89 | 938,40 | 938,40 | 1.618,51 |
| 500,0 | 524,0 | F2100500W1E | 925,24 | 925,24 | 1.647,51 | 869,89 | 869,89 | 1.592,16 | 959,52 | 959,52 | 1.681,78 |
| 525,0 | 549,0 | F2100525W1E | 946,32 | 946,32 | 1.708,13 | 896,27 | 896,27 | 1.655,39 | 985,87 | 985,87 | 1.745,00 |
| 550,0 | 574,0 | F2100550W1E | 972,67 | 972,67 | 1.776,67 | 914,71 | 914,71 | 1.718,67 | 1.004,32 | 1.004,32 | 1.808,30 |
| 575,0 | 599,0 | F2100575W1E | 993,78 | 993,78 | 1.834,65 | 938,40 | 938,40 | 1.781,94 | 1.028,02 | 1.028,02 | 1.871,56 |
| 600,0 | 624,0 | F2100600W1E | 1.051,77 | 1.051,77 | 1.892,66 | 1.001,68 | 1.001,68 | 1.842,57 | 1.091,30 | 1.091,30 | 1.932,20 |
| 625,0 | 649,0 | F2100625W1E | 1.072,82 | 1.072,82 | 1.963,81 | 1.014,87 | 1.014,87 | 1.905,83 | 1.104,50 | 1.104,50 | 1.995,46 |
| 650,0 | 674,0 | F2100650W1E | 1.093,97 | 1.093,97 | 2.021,82 | 1.038,58 | 1.038,58 | 1.969,09 | 1.128,22 | 1.128,22 | 2.058,70 |
| 675,0 | 699,0 | F2100675W1E | 1.115,03 | 1.115,03 | 2.079,81 | 1.067,56 | 1.067,56 | 2.029,74 | 1.157,19 | 1.157,19 | 2.119,37 |
| 700,0 | 724,0 | F2100700W1E | 1.141,39 | 1.141,39 | 2.143,07 | 1.091,30 | 1.091,30 | 2.092,96 | 1.180,93 | 1.180,93 | 2.182,59 |
| 725,0 | 749,0 | F2100725W1E | 1.162,46 | 1.162,46 | 2.198,43 | | | | 2.407,93 | 2.407,93 | 4.319,87 |
| 750,0 | 799,0 | F2100750W1E | 1.180,93 | 1.180,93 | 2.230,05 | | | | 2.443,76 | 2.443,76 | 4.457,30 |
| 800,0 | 849,0 | F2100800W1E | 1.228,40 | 1.228,40 | 2.288,07 | | | | 2.485,55 | 2.485,55 | 4.600,69 |

Acoplamiento para tubos de cualquier material sin anclaje axial.

Acoplamiento de unión y compensador todo en uno.

Código W1 en NBR termina W1N
Código W1 en FKM termina W1F

Código W2 en EPDM termina W2E
Código W2 en NBR termina W2N
Código W2 en FKM termina W2F

Código W5 en EPDM termina W5E
Código W5 en NBR termina W5N
Código W5 en FKM termina W5F

Continúa en la página siguiente...

| desde Ø exterior | hasta Ø exterior | Ref. EPDM | W1 CARCASA GALVANIZADA. CIERRES GALVANIZADOS | | | W2 CARCASA EN ACERO INOX. CIERRES GALVANIZADOS | | | W5 CARCASA EN ACERO INOX. CIERRES EN ACERO INOX. | | |
|------------------|------------------|-------------|---|----------|--------------|---|----------|--------------|---|----------|--------------|
| | | | € EPDM | € NBR | € FKM (1) | € EPDM | € NBR | € FKM (1) | € EPDM | € NBR | € FKM (1) |
| 850,0 | 899,0 | F2100850W1E | 1.267,93 | 1.267,93 | 2.346,03 | | | | 2.527,39 | 2.527,39 | 4.738,13 |
| 900,0 | 949,0 | F2100900W1E | 1.315,37 | 1.315,37 | 2.464,66 | | | | 2.736,50 | 2.736,50 | 5.048,81 |
| 950,0 | 999,0 | F2100950W1E | 1.357,55 | 1.357,55 | 2.588,55 | | | | 2.775,37 | 2.775,37 | 5.189,23 |
| 1.000,0 | 1.049,0 | F2101000W1E | 2.027,08 | 2.027,08 | 3.331,92 | | | | 2.811,23 | 2.811,23 | 5.326,64 |
| 1.050,0 | 1.099,0 | F2101050W1E | 2.098,23 | 2.098,23 | 3.461,08 | | | | 2.859,02 | 2.859,02 | 5.470,04 |
| 1.100,0 | 1.149,0 | F2101100W1E | 2.158,90 | 2.158,90 | 3.577,04 | | | | 2.984,48 | 2.984,48 | 5.703,06 |
| 1.150,0 | 1.199,0 | F2101150W1E | 2.222,13 | 2.222,13 | 3.698,31 | | | | 3.041,25 | 3.041,25 | 5.855,41 |
| 1.200,0 | 1.249,0 | F2101200W1E | 2.285,41 | 2.285,41 | 3.822,21 | | | | | | |
| 1.250,0 | 1.299,0 | F2101250W1E | 2.351,30 | 2.351,30 | 3.948,73 | | | | | | |
| 1.300,0 | 1.349,0 | F2101300W1E | 2.417,21 | 2.417,21 | 4.072,63 | | | | | | |
| 1.350,0 | 1.399,0 | F2101350W1E | 2.480,47 | 2.480,47 | 4.196,51 | | | | | | |
| 1.400,0 | 1.449,0 | F2101400W1E | 2.546,37 | 2.546,37 | 4.325,69 | | | | | | |
| 1.450,0 | 1.499,0 | F2101450W1E | 2.612,29 | 2.612,29 | 4.449,58 | | | | | | |
| 1.500,0 | 1.549,0 | F2101500W1E | 2.678,18 | 2.678,18 | 4.576,11 | | | | | | |
| 1.550,0 | 1.600,0 | F2101550W1E | 2.741,47 | 2.741,47 | 4.700,00 | | | | | | |
| 1.600,0 | 1.649,0 | F2101600W1E | 2.807,35 | 2.807,35 | 4.823,89 | | | | | | |
| 1.650,0 | 1.699,0 | F2101650W1E | 2.873,24 | 2.873,24 | 4.950,40 | | | | | | |
| 1.700,0 | 1.749,0 | F2101700W1E | 2.936,50 | 2.936,50 | 5.074,30 | | | | | | |
| 1.750,0 | 1.799,0 | F2101750W1E | 3.002,39 | 3.002,39 | 5.198,21 | | | | | | |
| 1.800,0 | 1.849,0 | F2101800W1E | 3.068,30 | 3.068,30 | 5.324,70 | | | | | | |
| 1.850,0 | 1.899,0 | F2101850W1E | 3.134,19 | 3.134,19 | 5.448,58 | | | | | | |
| 1.900,0 | 1.949,0 | F2101900W1E | 3.197,47 | 3.197,47 | 5.575,17 | | | | | | |
| 1.950,0 | 1.999,0 | F2101950W1E | 3.263,36 | 3.263,36 | 5.699,04 | | | | | | |
| 2.000,0 | 2.032,0 | F2102000W1E | 3.329,30 | 3.329,30 | 5.822,91 | | | | | | |

Código W1 en NBR termina W1N

Código W1 en FKM termina W1F

Código W5 en EPDM termina W5E

Código W5 en NBR termina W5N

Código W5 en FKM termina W5F

(1) Los acoplamientos con la junta en FKM llevan incluido un anillo interior en acero inoxidable.

En caso de pedido indicar el diámetro exterior exacto.

Junta: EPDM: -20°C hasta +100°C NBR: -20°C hasta +80°C FKM: -20°C hasta +180°C

Fluido: EPDM: Todas las calidades de agua, aguas residuales, aire, sólidos y diversos productos químicos.

NBR: Agua, gas, aceite, combustible y otros hidrocarburos.

FKM: Ozono, oxígeno, ácidos, gas, aceite y carburantes.

Especificar 1 o 2 cierres



FLEX 2 PN 16



Consultar

| desde Ø exterior | hasta Ø exterior | Ref. EPDM | W1 CARCASA GALVANIZADA. CIERRES GALVANIZADOS | | | W2 CARCASA EN ACERO INOX. CIERRES GALVANIZADOS | | | W5 CARCASA EN ACERO INOX. CIERRES EN ACERO INOX. | | |
|------------------|------------------|-------------|---|----------|-----------|---|--------|-----------|---|----------|-----------|
| | | | € EPDM | € NBR | € FKM (1) | € EPDM | € NBR | € FKM (1) | € EPDM | € NBR | € FKM (1) |
| 172,0 | 199,0 | | | | | 723,33 | 723,33 | 709,07 | 569,37 | 569,37 | 793,42 |
| 200,0 | 224,0 | | | | | 771,75 | 771,75 | 756,53 | 587,84 | 587,84 | 840,88 |
| 225,0 | 249,0 | | | | | 919,62 | 919,62 | 901,50 | 748,62 | 748,62 | 991,13 |
| 250,0 | 274,0 | | | | | 984,18 | 984,18 | 964,78 | 769,75 | 769,75 | 1.054,41 |
| 275,0 | 299,0 | F2160275W1E | 801,35 | 801,35 | 1.133,48 | 695,90 | 695,90 | 1.025,40 | 785,53 | 785,53 | 1.115,03 |
| 300,0 | 324,0 | F2160300W1E | 814,53 | 814,53 | 1.191,46 | 714,32 | 714,32 | 1.091,30 | 803,95 | 803,95 | 1.180,93 |
| 325,0 | 349,0 | F2160325W1E | 827,69 | 827,69 | 1.254,72 | 727,51 | 727,51 | 1.154,57 | 817,15 | 817,15 | 1.244,20 |
| 350,0 | 374,0 | F2160350W1E | 840,89 | 840,89 | 1.307,46 | 748,62 | 748,62 | 1.215,20 | 838,25 | 838,25 | 1.304,81 |
| 375,0 | 399,0 | F2160375W1E | 854,09 | 854,09 | 1.370,71 | 761,80 | 761,80 | 1.278,46 | 851,45 | 851,45 | 1.368,10 |
| 400,0 | 424,0 | F2160400W1E | 872,51 | 872,51 | 1.433,96 | 780,25 | 780,25 | 1.341,70 | 869,89 | 869,89 | 1.431,34 |
| 425,0 | 449,0 | F2160425W1E | 885,69 | 885,69 | 1.484,08 | | | | 2.082,26 | 2.082,26 | 3.393,77 |
| 450,0 | 474,0 | F2160450W1E | 898,89 | 898,89 | 1.539,42 | | | | 2.106,17 | 2.106,17 | 3.465,46 |
| 475,0 | 499,0 | F2160475W1E | 914,71 | 914,71 | 1.594,75 | | | | 2.124,10 | 2.124,10 | 3.531,17 |
| 500,0 | 524,0 | F2160500W1E | 925,24 | 925,24 | 1.647,51 | | | | 2.142,02 | 2.142,02 | 3.602,89 |
| 525,0 | 549,0 | F2160525W1E | 946,32 | 946,32 | 1.708,13 | | | | 2.159,95 | 2.159,95 | 3.671,61 |
| 550,0 | 574,0 | F2160550W1E | 972,67 | 972,67 | 1.776,67 | | | | 2.177,85 | 2.177,85 | 3.737,31 |
| 575,0 | 599,0 | F2160575W1E | 993,78 | 993,78 | 1.834,65 | | | | 2.195,80 | 2.195,80 | 3.809,02 |
| 600,0 | 624,0 | F2160600W1E | 1.051,77 | 1.051,77 | 1.892,66 | | | | 2.261,51 | 2.261,51 | 3.922,56 |
| 625,0 | 649,0 | F2160625W1E | 1.555,22 | 1.555,22 | 2.446,20 | | | | 2.279,42 | 2.279,42 | 3.994,28 |
| 650,0 | 674,0 | F2160650W1E | 1.589,51 | 1.589,51 | 2.517,40 | | | | 2.300,35 | 2.300,35 | 4.065,94 |
| 675,0 | 699,0 | F2160675W1E | 1.618,51 | 1.618,51 | 2.583,28 | | | | 2.324,24 | 2.324,24 | 4.134,66 |
| 700,0 | 724,0 | F2160700W1E | 1.650,11 | 1.650,11 | 2.651,86 | | | | 2.386,99 | 2.386,99 | 4.248,18 |
| 725,0 | 749,0 | F2160725W1E | 1.684,39 | 1.684,39 | 2.720,35 | | | | 2.407,93 | 2.407,93 | 4.319,87 |
| 750,0 | 799,0 | F2160750W1E | 1.710,79 | 1.710,79 | 2.786,28 | | | | 2.443,76 | 2.443,76 | 4.457,30 |
| 800,0 | 849,0 | F2160800W1E | 1.781,94 | 1.781,94 | 2.852,16 | | | | 2.485,55 | 2.485,55 | 4.600,69 |
| 850,0 | 899,0 | F2160850W1E | 1.839,95 | 1.839,95 | 2.918,05 | | | | | | |
| 900,0 | 949,0 | F2160900W1E | 1.905,83 | 1.905,83 | 3.057,74 | | | | | | |
| 950,0 | 999,0 | F2160950W1E | 1.969,09 | 1.969,09 | 3.197,47 | | | | | | |
| 1.000,0 | 1.049,0 | F2161000W1E | 2.027,08 | 2.027,08 | 3.331,92 | | | | | | |
| 1.050,0 | 1.099,0 | F2161050W1E | 2.098,23 | 2.098,23 | 3.461,08 | | | | | | |
| 1.100,0 | 1.149,0 | F2161100W1E | 2.158,90 | 2.158,90 | 3.577,04 | | | | | | |
| 1.150,0 | 1.199,0 | F2161150W1E | 2.222,13 | 2.222,13 | 3.698,31 | | | | | | |
| 1.200,0 | 1.249,0 | F2161200W1E | 2.285,41 | 2.285,41 | 3.822,21 | | | | | | |
| 1.250,0 | 1.299,0 | F2161250W1E | 2.351,30 | 2.351,30 | 3.948,73 | | | | | | |
| 1.300,0 | 1.349,0 | F2161300W1E | 2.417,21 | 2.417,21 | 4.072,63 | | | | | | |
| 1.350,0 | 1.399,0 | F2161350W1E | 2.480,47 | 2.480,47 | 4.196,51 | | | | | | |
| 1.400,0 | 1.449,0 | F2161400W1E | 2.546,37 | 2.546,37 | 4.325,69 | | | | | | |
| 1.450,0 | 1.499,0 | F2161450W1E | 2.612,29 | 2.612,29 | 4.449,58 | | | | | | |

Acoplamiento para tubos de cualquier material sin anclaje axial.

Acoplamiento de unión y compensador todo en uno.

Código W1 en NBR termina W1N
Código W1 en FKM termina W1F

Código W2 en EPDM termina W2E
Código W2 en NBR termina W2N
Código W2 en FKM termina W2F

Código W5 en EPDM termina W5E
Código W5 en NBR termina W5N
Código W5 en FKM termina W5F

(1) Los acoplamientos con la junta en FKM llevan incluido un anillo interior en acero inoxidable.

En caso de pedido indicar el diámetro exterior exacto.

Junta: EPDM: -20°C hasta +100°C NBR: -20°C hasta +80°C FKM: -20°C hasta +180°C

Fluido: EPDM: Todas las calidades de agua, aguas residuales, aire, sólidos y diversos productos químicos.

NBR: Agua, gas, aceite, combustible y otros hidrocarburos.

FKM: Ozono, oxígeno, ácidos, gas, aceite y carburantes.

Especificar 1 o 2 cierres

FLEX 2 PN 20  PN  Consultar

| desde Ø exterior | hasta Ø exterior | Ref. EPDM | W1 CARCASA GALVANIZADA. CIERRES GALVANIZADOS | | | W2 CARCASA EN ACERO INOX. CIERRES GALVANIZADOS | | | W5 CARCASA EN ACERO INOX. CIERRES EN ACERO INOX. | | |
|------------------|------------------|-------------|---|----------|-----------|---|--------|-----------|---|----------|-----------|
| | | | € EPDM | € NBR | € FKM (1) | € EPDM | € NBR | € FKM (1) | € EPDM | € NBR | € FKM (1) |
| 180,0 | 199,0 | | | | | 624,71 | 624,71 | 785,53 | 714,33 | 714,33 | 875,16 |
| 200,0 | 224,0 | | | | | 643,18 | 643,18 | 838,25 | 732,79 | 732,79 | 927,87 |
| 225,0 | 249,0 | | | | | 658,97 | 658,97 | 901,50 | 748,62 | 748,62 | 991,13 |
| 250,0 | 274,0 | | | | | 680,12 | 680,12 | 964,78 | 769,75 | 769,75 | 1.054,41 |
| 275,0 | 299,0 | F2200275W1E | 801,35 | 801,35 | 1.133,48 | 695,90 | 695,90 | 1.025,40 | 785,53 | 785,53 | 1.115,03 |
| 300,0 | 324,0 | F2200300W1E | 814,53 | 814,53 | 1.191,46 | 714,32 | 714,32 | 1.091,30 | 803,95 | 803,95 | 1.180,93 |
| 325,0 | 349,0 | F2200325W1E | 827,69 | 827,69 | 1.254,72 | | | | 2.010,55 | 2.010,55 | 3.115,94 |
| 350,0 | 374,0 | F2200350W1E | 840,89 | 840,89 | 1.307,46 | | | | 2.025,50 | 2.025,50 | 3.184,64 |
| 375,0 | 399,0 | F2200375W1E | 854,09 | 854,09 | 1.370,71 | | | | 2.049,41 | 2.049,41 | 3.259,33 |
| 400,0 | 424,0 | F2200400W1E | 872,51 | 872,51 | 1.433,96 | | | | 2.064,33 | 2.064,33 | 3.325,06 |
| 425,0 | 449,0 | F2200425W1E | 885,69 | 885,69 | 1.484,08 | | | | 2.082,26 | 2.082,26 | 3.393,77 |
| 450,0 | 474,0 | F2200450W1E | 898,89 | 898,89 | 1.539,42 | | | | 2.106,17 | 2.106,17 | 3.465,46 |
| 475,0 | 499,0 | F2200475W1E | 1.325,90 | 1.325,90 | 2.003,34 | | | | 2.124,10 | 2.124,10 | 3.531,17 |
| 500,0 | 524,0 | F2200500W1E | 1.341,70 | 1.341,70 | 2.064,02 | | | | 2.142,02 | 2.142,02 | 3.602,89 |
| 525,0 | 549,0 | F2200525W1E | 1.370,71 | 1.370,71 | 2.132,50 | | | | 2.159,95 | 2.159,95 | 3.671,61 |
| 550,0 | 574,0 | F2200550W1E | 1.410,26 | 1.410,26 | 2.211,59 | | | | 2.177,85 | 2.177,85 | 3.737,31 |
| 575,0 | 599,0 | F2200575W1E | 1.439,25 | 1.439,25 | 2.280,16 | | | | 2.195,80 | 2.195,80 | 3.809,02 |
| 600,0 | 624,0 | F2200600W1E | 1.523,59 | 1.523,59 | 2.364,51 | | | | 2.261,51 | 2.261,51 | 3.922,56 |
| 625,0 | 649,0 | F2200625W1E | 1.555,22 | 1.555,22 | 2.446,20 | | | | 2.279,42 | 2.279,42 | 3.994,28 |
| 650,0 | 674,0 | F2200650W1E | 1.589,51 | 1.589,51 | 2.517,40 | | | | | | |
| 675,0 | 699,0 | F2200675W1E | 1.618,51 | 1.618,51 | 2.583,28 | | | | | | |
| 700,0 | 724,0 | F2200700W1E | 1.650,11 | 1.650,11 | 2.651,86 | | | | | | |
| 725,0 | 749,0 | F2200725W1E | 1.684,39 | 1.684,39 | 2.720,35 | | | | | | |
| 750,0 | 799,0 | F2200750W1E | 1.710,79 | 1.710,79 | 2.786,28 | | | | | | |
| 800,0 | 849,0 | F2200800W1E | 1.781,94 | 1.781,94 | 2.852,16 | | | | | | |
| 850,0 | 899,0 | F2200850W1E | 1.839,95 | 1.839,95 | 2.918,05 | | | | | | |
| 900,0 | 949,0 | F2200900W1E | 1.905,83 | 1.905,83 | 3.057,74 | | | | | | |
| 950,0 | 999,0 | F2200950W1E | 1.969,09 | 1.969,09 | 3.197,47 | | | | | | |

Acoplamiento para tubos de cualquier material sin anclaje axial.

Acoplamiento de unión y compensador todo en uno.

Código W1 en NBR termina W1N
Código W1 en FKM termina W1F

Código W2 en EPDM termina W2E
Código W2 en NBR termina W2N
Código W2 en FKM termina W2F

Código W5 en EPDM termina W5E
Código W5 en NBR termina W5N
Código W5 en FKM termina W5F

(1) Los acoplamientos con la junta en FKM llevan incluido un anillo interior en acero inoxidable.

En caso de pedido indicar el diámetro exterior exacto.

Junta: EPDM: -20°C hasta +100°C NBR: -20°C hasta +80°C FKM: -20°C hasta +180°C

Fluido: EPDM: Todas las calidades de agua, aguas residuales, aire, sólidos y diversos productos químicos.

NBR: Agua, gas, aceite, combustible y otros hidrocarburos.

FKM: Ozono, oxígeno, ácidos, gas, aceite y carburantes.

Especificar 1 o 2 cierres

FLEX 2 PN 25  PN  Consultar

| desde Ø exterior | hasta Ø exterior | Ref. EPDM | W1 CARCASA GALVANIZADA. CIERRES GALVANIZADOS | | | W2 CARCASA EN ACERO INOX. CIERRES GALVANIZADOS | | | W5 CARCASA EN ACERO INOX. CIERRES EN ACERO INOX. | | |
|------------------|------------------|-------------|---|----------|-----------|---|--------|-----------|---|----------|-----------|
| | | | € EPDM | € NBR | € FKM (1) | € EPDM | € NBR | € FKM (1) | € EPDM | € NBR | € FKM (1) |
| 180,0 | 199,0 | | | | | 832,96 | 832,96 | 993,78 | 922,60 | 922,60 | 1.083,40 |
| 200,0 | 224,0 | | | | | 851,43 | 851,43 | 1.049,14 | 941,05 | 941,05 | 1.138,76 |
| 225,0 | 249,0 | | | | | 872,52 | 872,52 | 1.112,38 | 962,14 | 962,14 | 1.202,01 |
| 250,0 | 274,0 | | | | | 896,25 | 896,25 | 1.180,92 | 985,87 | 985,87 | 1.270,54 |
| 275,0 | 299,0 | F2250275W1E | 801,35 | 801,35 | 1.133,48 | | | | 1.974,70 | 1.974,70 | 2.984,48 |
| 300,0 | 324,0 | F2250300W1E | 814,53 | 814,53 | 1.191,46 | | | | 1.989,67 | 1.989,67 | 3.053,21 |
| 325,0 | 349,0 | F2250325W1E | 827,69 | 827,69 | 1.254,72 | | | | 2.010,55 | 2.010,55 | 3.115,94 |
| 350,0 | 374,0 | F2250350W1E | 1.217,83 | 1.217,83 | 1.687,06 | | | | 2.025,50 | 2.025,50 | 3.184,64 |
| 375,0 | 399,0 | F2250375W1E | 1.241,55 | 1.241,55 | 1.755,58 | | | | 2.049,41 | 2.049,41 | 3.259,33 |
| 400,0 | 424,0 | F2250400W1E | 1.262,66 | 1.262,66 | 1.824,08 | | | | 2.064,33 | 2.064,33 | 3.325,06 |
| 425,0 | 449,0 | F2250425W1E | 1.283,72 | 1.283,72 | 1.884,76 | | | | 2.082,26 | 2.082,26 | 3.393,77 |
| 450,0 | 474,0 | F2250450W1E | 1.302,21 | 1.302,21 | 1.942,72 | | | | 2.106,17 | 2.106,17 | 3.465,46 |
| 475,0 | 499,0 | F2250475W1E | 1.325,90 | 1.325,90 | 2.003,34 | | | | 2.124,10 | 2.124,10 | 3.531,17 |
| 500,0 | 524,0 | F2250500W1E | 1.341,70 | 1.341,70 | 2.064,02 | | | | 2.142,02 | 2.142,02 | 3.602,89 |
| 525,0 | 549,0 | F2250525W1E | 1.370,71 | 1.370,71 | 2.132,50 | | | | | | |
| 550,0 | 574,0 | F2250550W1E | 1.410,26 | 1.410,26 | 2.211,59 | | | | | | |
| 575,0 | 599,0 | F2250575W1E | 1.439,25 | 1.439,25 | 2.280,16 | | | | | | |
| 600,0 | 624,0 | F2250600W1E | 1.523,59 | 1.523,59 | 2.364,51 | | | | | | |
| 625,0 | 649,0 | F2250625W1E | 1.555,22 | 1.555,22 | 2.446,20 | | | | | | |
| 650,0 | 674,0 | F2250650W1E | 1.589,51 | 1.589,51 | 2.517,40 | | | | | | |
| 675,0 | 699,0 | F2250675W1E | 1.618,51 | 1.618,51 | 2.583,28 | | | | | | |
| 700,0 | 724,0 | F2250700W1E | 1.650,11 | 1.650,11 | 2.651,86 | | | | | | |
| 725,0 | 749,0 | F2250725W1E | 1.684,39 | 1.684,39 | 2.720,35 | | | | | | |

Acoplamiento para tubos de cualquier material sin anclaje axial.

Acoplamiento de unión y compensador todo en uno.

Código W1 en NBR termina W1N
Código W1 en FKM termina W1F

Código W2 en EPDM termina W2E
Código W2 en NBR termina W2N
Código W2 en FKM termina W2F

Código W5 en EPDM termina W5E
Código W5 en NBR termina W5N
Código W5 en FKM termina W5F

(1) Los acoplamientos con la junta en FKM llevan incluido un anillo interior en acero inoxidable.

En caso de pedido indicar el diámetro exterior exacto.

Junta: EPDM: -20°C hasta +100°C NBR: -20°C hasta +80°C FKM: -20°C hasta +180°C

Fluido: EPDM: Todas las calidades de agua, aguas residuales, aire, sólidos y diversos productos químicos.

NBR: Agua, gas, aceite, combustible y otros hidrocarburos.

FKM: Ozono, oxígeno, ácidos, gas, aceite y carburantes.

Especificar 1 o 2 cierres

FLEX 3 PN 2,5

 Consultar

| desde Ø exterior | hasta Ø exterior | W1 CARCASA GALVANIZADA. CIERRES GALVANIZADOS | | | W2 CARCASA EN ACERO INOX. CIERRES GALVANIZADOS | | W5 CARCASA EN ACERO INOX. CIERRES EN ACERO INOX. | |
|------------------|------------------|---|----------|----------|---|----------|---|----------|
| | | Ref. EPDM | € EPDM | € NBR | € EPDM | € NBR | € EPDM | € NBR |
| 219,1 | 249,0 | | | | | 2.129,90 | 1.876,82 | 2.330,22 |
| 250,0 | 299,0 | | | | | 2.211,58 | 1.942,73 | 2.411,94 |
| 300,0 | 349,0 | F3020300W1E | 1.476,14 | 1.992,81 | 1.386,50 | 1.913,72 | 1.586,89 | 2.114,09 |
| 350,0 | 399,0 | F3020350W1E | 1.531,53 | 2.066,63 | 1.468,26 | 2.027,08 | 1.668,59 | 2.227,41 |
| 400,0 | 449,0 | F3020400W1E | 1.586,89 | 2.140,43 | 1.549,98 | 2.140,43 | 1.750,32 | 2.340,78 |
| 450,0 | 499,0 | F3020450W1E | 1.639,58 | 2.211,59 | 1.631,69 | 2.251,15 | 1.832,02 | 2.451,47 |
| 500,0 | 549,0 | F3020500W1E | 1.694,93 | 2.285,41 | 1.713,39 | 2.364,51 | 1.913,72 | 2.564,82 |
| 550,0 | 599,0 | F3020550W1E | 1.747,66 | 2.359,23 | 1.795,14 | 2.475,20 | 1.995,46 | 2.675,54 |
| 600,0 | 649,0 | F3020600W1E | 1.803,03 | 2.433,04 | 1.876,82 | 2.591,18 | 2.077,17 | 2.791,54 |
| 650,0 | 699,0 | F3020650W1E | 1.861,04 | 2.512,13 | 1.961,17 | 2.704,52 | 2.161,54 | 2.904,86 |
| 700,0 | 749,0 | F3020700W1E | 1.908,46 | 2.575,36 | 2.042,90 | 2.817,88 | 2.243,25 | 3.018,23 |
| 750,0 | 799,0 | F3020750W1E | 1.966,46 | 2.651,86 | 2.121,96 | 2.928,59 | 2.322,32 | 3.128,90 |
| 800,0 | 849,0 | F3020800W1E | 2.021,82 | 2.730,90 | 2.203,73 | 3.044,54 | 2.404,04 | 3.244,94 |
| 850,0 | 899,0 | F3020850W1E | 2.085,09 | 2.815,25 | 2.285,41 | 3.155,31 | 2.485,73 | 3.355,62 |
| 900,0 | 949,0 | F3020900W1E | 2.150,97 | 2.902,24 | 2.364,51 | 3.263,36 | 2.564,82 | 3.463,71 |
| 950,0 | 999,0 | F3020950W1E | 2.214,28 | 2.991,86 | 2.448,85 | 3.379,36 | 2.649,17 | 3.579,66 |
| 1.000,0 | 1.049,0 | F3021000W1E | 2.280,16 | 3.078,84 | 2.525,28 | 3.482,14 | 2.725,61 | 3.682,51 |
| 1.050,0 | 1.099,0 | F3021050W1E | 2.348,67 | 3.171,12 | 2.609,65 | 3.600,77 | 2.809,96 | 3.801,09 |
| 1.100,0 | 1.149,0 | F3021100W1E | 2.411,93 | 3.255,47 | 2.691,38 | 3.714,12 | 2.891,72 | 3.914,45 |
| 1.150,0 | 1.199,0 | F3021150W1E | 2.464,66 | 3.329,30 | 2.773,09 | 3.824,85 | 2.973,39 | 4.025,16 |
| 1.200,0 | 1.249,0 | F3021200W1E | 2.541,09 | 3.432,07 | 2.823,16 | 3.895,99 | 3.023,49 | 4.096,37 |
| 1.250,0 | 1.299,0 | F3021250W1E | 2.620,17 | 3.537,49 | 2.878,51 | 3.972,45 | 3.078,84 | 4.172,79 |
| 1.300,0 | 1.349,0 | F3021300W1E | 2.696,66 | 3.640,32 | 2.928,59 | 4.043,62 | 3.128,90 | 4.243,96 |
| 1.350,0 | 1.399,0 | F3021350W1E | 2.775,69 | 3.745,74 | 2.983,96 | 4.120,07 | 3.184,30 | 4.320,41 |
| 1.400,0 | 1.449,0 | F3021400W1E | 2.852,16 | 3.851,19 | 3.041,97 | 4.196,51 | 3.242,27 | 4.396,85 |
| 1.450,0 | 1.499,0 | F3021450W1E | 2.925,97 | 3.951,40 | 3.110,48 | 4.291,43 | 3.310,83 | 4.491,74 |
| 1.500,0 | 1.549,0 | F3021500W1E | 3.005,07 | 4.056,81 | 3.181,67 | 4.391,58 | 3.381,98 | 4.591,90 |
| 1.550,0 | 1.599,0 | F3021550W1E | 3.078,84 | 4.156,99 | 3.442,60 | 4.752,73 | 3.642,98 | 4.953,07 |
| 1.600,0 | 1.649,0 | F3021600W1E | 3.147,38 | 4.249,23 | 3.519,07 | 4.855,51 | 3.719,40 | 5.055,82 |
| 1.650,0 | 1.699,0 | F3021650W1E | 3.218,53 | 4.344,11 | 3.592,88 | 4.958,33 | 3.793,21 | 5.158,65 |
| 1.700,0 | 1.749,0 | F3021700W1E | 3.281,82 | 4.431,13 | 3.666,66 | 5.058,49 | 3.867,02 | 5.258,82 |
| 1.750,0 | 1.799,0 | F3021750W1E | 3.363,56 | 4.541,83 | 3.851,19 | 5.314,18 | 4.051,56 | 5.514,52 |
| 1.800,0 | 1.849,0 | F3021800W1E | 3.450,52 | 4.657,79 | 3.938,19 | 5.432,81 | 4.138,51 | 5.633,13 |
| 1.850,0 | 1.899,0 | F3021850W1E | 3.534,87 | 4.773,82 | 4.014,62 | 5.540,89 | 4.214,99 | 5.741,20 |
| 1.900,0 | 1.949,0 | F3021900W1E | 3.621,86 | 4.889,77 | 4.096,37 | 5.651,57 | 4.296,70 | 5.851,91 |
| 1.950,0 | 1.999,0 | F3021950W1E | 3.711,47 | 5.008,41 | 4.178,07 | 5.767,57 | 4.378,39 | 5.967,92 |
| 2.000,0 | 2.032,0 | F3022000W1E | 3.801,09 | 5.132,33 | 4.280,87 | 5.907,28 | 4.481,19 | 6.107,63 |

Acoplamiento para tubos de cualquier material sin anclaje axial.

Acoplamiento de unión y compensador todo en uno.

Código W1 en NBR termina W1N

Código W2 en EPDM termina W2E
Código W2 en NBR termina W2N

Código W5 en EPDM termina W5E
Código W5 en NBR termina W5N

En caso de pedido indicar el diámetro exterior exacto.

Junta: EPDM: -20°C hasta +100°C NBR: -20°C hasta +80°C
Fluido: EPDM: Todas las calidades de agua, aguas residuales, aire, sólidos y diversos productos químicos.
 NBR: Agua, gas, aceite, combustible y otros hidrocarburos.
 Especificar 1 o 2 cierres



FLEX 3 PN 6

 Consultar

| desde Ø exterior | hasta Ø exterior | W1 CARCASA GALVANIZADA. CIERRES GALVANIZADOS | | | W2 CARCASA EN ACERO INOX. CIERRES GALVANIZADOS | | W5 CARCASA EN ACERO INOX. CIERRES EN ACERO INOX. | |
|------------------|------------------|---|----------|----------|---|----------|---|----------|
| | | Ref. EPDM | € EPDM | € NBR | € EPDM | € NBR | € EPDM | € NBR |
| 219,1 | 249,0 | | | | | 2.129,90 | 1.876,82 | 2.330,22 |
| 250,0 | 299,0 | | | | | 2.211,58 | 1.942,73 | 2.411,94 |
| 300,0 | 349,0 | F3060300W1E | 1.476,14 | 1.992,81 | 1.386,50 | 1.913,72 | 1.586,89 | 2.114,09 |
| 350,0 | 399,0 | F3060350W1E | 1.531,53 | 2.066,63 | 1.468,26 | 2.027,08 | 1.668,59 | 2.227,41 |
| 400,0 | 449,0 | F3060400W1E | 1.586,89 | 2.140,43 | 1.549,98 | 2.140,43 | 1.750,32 | 2.340,78 |
| 450,0 | 499,0 | F3060450W1E | 1.639,58 | 2.211,59 | 1.631,69 | 2.251,15 | 1.832,02 | 2.451,47 |
| 500,0 | 549,0 | F3060500W1E | 1.694,93 | 2.285,41 | 1.713,39 | 2.364,51 | 1.913,72 | 2.564,82 |
| 550,0 | 599,0 | F3060550W1E | 1.747,66 | 2.359,23 | 1.795,14 | 2.475,20 | 1.995,46 | 2.675,54 |
| 600,0 | 649,0 | F3060600W1E | 1.803,03 | 2.433,04 | 1.876,82 | 2.591,18 | 2.077,17 | 2.791,54 |
| 650,0 | 699,0 | F3060650W1E | 1.861,04 | 2.512,13 | 1.961,17 | 2.704,52 | 2.161,54 | 2.904,86 |
| 700,0 | 749,0 | F3060700W1E | 1.908,46 | 2.575,36 | 2.042,90 | 2.817,88 | 2.243,25 | 3.018,23 |
| 750,0 | 799,0 | F3060750W1E | 1.966,46 | 2.651,86 | 2.121,96 | 2.928,59 | 2.322,32 | 3.128,90 |
| 800,0 | 849,0 | F3060800W1E | 2.021,82 | 2.730,90 | 2.203,73 | 3.044,54 | 2.404,04 | 3.244,94 |
| 850,0 | 899,0 | F3060850W1E | 2.085,09 | 2.815,25 | 2.285,41 | 3.155,31 | 2.485,73 | 3.355,62 |
| 900,0 | 949,0 | F3060900W1E | 2.150,97 | 2.902,24 | 2.364,51 | 3.263,36 | 2.564,82 | 3.463,71 |
| 950,0 | 999,0 | F3060950W1E | 2.214,28 | 2.991,86 | 2.448,85 | 3.379,36 | 2.649,17 | 3.579,66 |
| 1.000,0 | 1.049,0 | F3061000W1E | 2.280,16 | 3.078,84 | | | 3.907,61 | 4.149,59 |
| 1.050,0 | 1.099,0 | F3061050W1E | 2.348,67 | 3.171,12 | | | 3.982,26 | 4.233,23 |
| 1.100,0 | 1.149,0 | F3061100W1E | 2.411,93 | 3.255,47 | | | 4.053,97 | 4.313,92 |
| 1.150,0 | 1.199,0 | F3061150W1E | 2.464,66 | 3.329,30 | | | 4.134,66 | 4.412,48 |
| 1.200,0 | 1.249,0 | F3061200W1E | 2.541,09 | 3.432,07 | | | 4.221,30 | 4.508,09 |
| 1.250,0 | 1.299,0 | F3061250W1E | 2.620,17 | 3.537,49 | | | 4.307,93 | 4.603,71 |
| 1.300,0 | 1.349,0 | F3061300W1E | 2.696,66 | 3.640,32 | | | 4.391,58 | 4.699,30 |
| 1.350,0 | 1.399,0 | F3061350W1E | 2.775,69 | 3.745,74 | | | 4.478,22 | 4.794,87 |
| 1.400,0 | 1.449,0 | F3061400W1E | 2.852,16 | 3.851,19 | | | 4.552,90 | 4.884,51 |
| 1.450,0 | 1.499,0 | F3061450W1E | 2.925,97 | 3.951,40 | | | 4.660,46 | 5.004,00 |
| 1.500,0 | 1.549,0 | F3061500W1E | 3.005,07 | 4.056,81 | | | 4.762,00 | 5.114,55 |
| 1.550,0 | 1.599,0 | F3061550W1E | 3.078,84 | 4.156,99 | | | 4.842,69 | 5.207,15 |
| 1.600,0 | 1.649,0 | F3061600W1E | 3.147,38 | 4.249,23 | | | 4.932,31 | 5.305,73 |
| 1.650,0 | 1.699,0 | F3061650W1E | 3.218,53 | 4.344,11 | | | 5.033,89 | 5.419,28 |
| 1.700,0 | 1.749,0 | F3061700W1E | 3.281,82 | 4.431,13 | | | 5.135,47 | 5.532,77 |
| 1.750,0 | 1.799,0 | F3061750W1E | 3.363,56 | 4.541,83 | | | 5.237,01 | 5.643,35 |
| 1.800,0 | 1.849,0 | F3061800W1E | 3.450,52 | 4.657,79 | | | 5.616,45 | 6.034,66 |
| 1.850,0 | 1.899,0 | F3061850W1E | 3.534,87 | 4.773,82 | | | 5.694,11 | 6.124,29 |
| 1.900,0 | 1.949,0 | F3061900W1E | 3.621,86 | 4.889,77 | | | 5.765,79 | 6.207,97 |
| 1.950,0 | 1.999,0 | F3061950W1E | 3.711,47 | 5.008,41 | | | 5.861,40 | 6.312,50 |
| 2.000,0 | 2.032,0 | F3062000W1E | 3.801,09 | 5.132,33 | | | 5.962,99 | 6.426,04 |

Acoplamiento para tubos de cualquier material sin anclaje axial.

Acoplamiento de unión y compensador todo en uno.

Código W1 en NBR termina W1N

Código W2 en EPDM termina W2E
Código W2 en NBR termina W2N

Código W5 en EPDM termina W5E
Código W5 en NBR termina W5N

En caso de pedido indicar el diámetro exterior exacto.

Junta: EPDM: -20°C hasta +100°C NBR: -20°C hasta +80°C

Fluido: EPDM: Todas las calidades de agua, aguas residuales, aire, sólidos y diversos productos químicos.

NBR: Agua, gas, aceite, combustible y otros hidrocarburos.

Especificar 1 o 2 cierres



FLEX 3 PN 10

 PN
  Consultar

| desde Ø exterior | hasta Ø exterior | W1 CARCASA GALVANIZADA. CIERRES GALVANIZADOS | | | W2 CARCASA EN ACERO INOX. CIERRES GALVANIZADOS | | W5 CARCASA EN ACERO INOX. CIERRES EN ACERO INOX. | |
|------------------|------------------|---|----------|----------|---|----------|---|-----------|
| | | Ref. EPDM | € EPDM | € NBR | € EPDM | € NBR | € EPDM | € NBR |
| 219,1 | 249,0 | | | | 1.676,51 | 2.129,90 | 1.876,82 | 2.330,22 |
| 250,0 | 299,0 | | | | 1.742,40 | 2.211,58 | 1.942,73 | 2.411,94 |
| 300,0 | 349,0 | F3100300W1E | 1.476,14 | 1.992,81 | 1.386,50 | 1.913,72 | 1.586,89 | 2.114,09 |
| 350,0 | 399,0 | F3100350W1E | 1.531,53 | 2.066,63 | 1.468,26 | 2.027,08 | 1.668,59 | 2.227,41 |
| 400,0 | 449,0 | F3100400W1E | 1.586,89 | 2.140,43 | 1.549,98 | 2.140,43 | 1.750,32 | 2.340,78 |
| 450,0 | 499,0 | F3100450W1E | 1.639,58 | 2.211,59 | 1.631,69 | 2.251,15 | 1.832,02 | 2.451,47 |
| 500,0 | 549,0 | F3100500W1E | 1.694,93 | 2.285,41 | | | 2.876,92 | 3.002,39 |
| 525,0 | 549,0 | | | | | | | |
| 550,0 | 599,0 | F3100550W1E | 1.747,66 | 2.359,23 | | | 3.008,38 | 3.145,80 |
| 575,0 | 599,0 | | | | | | | |
| 600,0 | 649,0 | F3100600W1E | 1.803,03 | 2.433,04 | | | 3.160,76 | 3.313,13 |
| 650,0 | 699,0 | F3100650W1E | 1.861,04 | 2.512,13 | | | 3.232,44 | 3.396,75 |
| 700,0 | 749,0 | F3100700W1E | 1.908,46 | 2.575,36 | | | 3.304,14 | 3.480,38 |
| 750,0 | 799,0 | F3100750W1E | 1.966,46 | 2.651,86 | | | 3.381,80 | 3.570,02 |
| 800,0 | 849,0 | F3100800W1E | 2.021,82 | 2.730,90 | | | 3.465,46 | 3.662,64 |
| 850,0 | 899,0 | F3100850W1E | 2.085,09 | 2.815,25 | | | 3.632,76 | 3.841,90 |
| 900,0 | 949,0 | F3100900W1E | 2.150,97 | 2.902,24 | | | 3.737,31 | 3.958,42 |
| 950,0 | 999,0 | F3100950W1E | 2.214,28 | 2.991,86 | | | 3.823,96 | 4.053,97 |
| 1.000,0 | 1.049,0 | F3101000W1E | 2.280,16 | 3.078,84 | | | 3.907,61 | 4.149,59 |
| 1.050,0 | 1.099,0 | F3101050W1E | 2.348,67 | 3.171,12 | | | 3.982,26 | 4.233,23 |
| 1.100,0 | 1.149,0 | F3101100W1E | 2.411,93 | 3.255,47 | | | 4.053,97 | 4.313,92 |
| 1.150,0 | 1.199,0 | F3101150W1E | 2.464,66 | 3.329,30 | | | 4.134,66 | 4.412,48 |
| 1.200,0 | 1.249,0 | F3101200W1E | 2.541,09 | 3.432,07 | | | 4.221,30 | 4.508,09 |
| 1.250,0 | 1.299,0 | F3101250W1E | 5.912,22 | 6.620,24 | | | 4.307,93 | 4.603,71 |
| 1.300,0 | 1.349,0 | F3101300W1E | 6.016,76 | 6.739,73 | | | 4.391,58 | 4.699,30 |
| 1.350,0 | 1.399,0 | F3101350W1E | 6.130,29 | 6.865,19 | | | 4.478,22 | 4.794,87 |
| 1.400,0 | 1.449,0 | F3101400W1E | 6.243,82 | 6.990,68 | | | 4.552,90 | 4.884,51 |
| 1.450,0 | 1.499,0 | F3101450W1E | 6.354,34 | 7.116,15 | | | Consultar | Consultar |
| 1.500,0 | 1.549,0 | F3101500W1E | 6.467,90 | 7.244,61 | | | | |
| 1.550,0 | 1.599,0 | F3101550W1E | 6.575,43 | 7.364,12 | | | | |
| 1.600,0 | 1.649,0 | F3101600W1E | 6.688,93 | 7.489,60 | | | | |
| 1.650,0 | 1.699,0 | F3101650W1E | 6.799,48 | 7.618,05 | | | | |
| 1.700,0 | 1.749,0 | F3101700W1E | 6.912,97 | 7.746,50 | | | | |
| 1.750,0 | 1.799,0 | F3101750W1E | 7.020,55 | 7.863,01 | | | | |
| 1.800,0 | 1.849,0 | F3101800W1E | 7.134,07 | 7.991,49 | | | | |
| 1.850,0 | 1.899,0 | F3101850W1E | 7.247,61 | 8.116,97 | | | | |
| 1.900,0 | 1.949,0 | F3101900W1E | 7.361,10 | 8.242,45 | | | | |
| 1.950,0 | 1.999,0 | F3101950W1E | 7.468,68 | 8.364,89 | | | | |
| 2.000,0 | 2.032,0 | F3102000W1E | 7.573,23 | 8.481,42 | | | | |

Acoplamiento para tubos de cualquier material sin anclaje axial.

Acoplamiento de unión y compensador todo en uno.

Código W1 en NBR termina W1N

Código W2 en EPDM termina W2E
Código W2 en NBR termina W2N

Código W5 en EPDM termina W5E
Código W5 en NBR termina W5N

En caso de pedido indicar el diámetro exterior exacto.

Junta: EPDM: -20°C hasta +100°C NBR: -20°C hasta +80°C
Fluido: EPDM: Todas las calidades de agua, aguas residuales, aire, sólidos y diversos productos químicos.

NBR: Agua, gas, aceite, combustible y otros hidrocarburos.

Especificar 1 o 2 cierres

FLEX 3 PN 16

 PN
 
 Consultar

| desde Ø exterior | hasta Ø exterior | W1 CARCASA GALVANIZADA. CIERRES GALVANIZADOS | | | W2 CARCASA EN ACERO INOX. CIERRES GALVANIZADOS | | W5 CARCASA EN ACERO INOX. CIERRES EN ACERO INOX. | |
|------------------|------------------|---|-----------|-----------|---|----------|---|-----------|
| | | Ref. EPDM | € EPDM | € NBR | € EPDM | € NBR | € EPDM | € NBR |
| 219,1 | 249,0 | | | | 1.676,51 | 2.129,90 | 1.876,82 | 2.330,22 |
| 250,0 | 299,0 | | | | 1.742,40 | 2.211,58 | 1.942,73 | 2.411,94 |
| 300,0 | 349,0 | F3160300W1E | 1.476,14 | 1.992,81 | 1.386,50 | 1.913,72 | 1.586,89 | 2.114,09 |
| 350,0 | 399,0 | F3160350W1E | 1.531,53 | 2.066,63 | | | 2.515,46 | 2.605,09 |
| 375,0 | 399,0 | | | | | | | |
| 400,0 | 449,0 | F3160400W1E | 1.586,89 | 2.140,43 | | | 2.631,98 | 2.736,50 |
| 425,0 | 449,0 | | | | | | | |
| 450,0 | 499,0 | F3160450W1E | 1.639,58 | 2.211,59 | | | 2.751,45 | 2.868,00 |
| 475,0 | 499,0 | | | | | | | |
| 500,0 | 549,0 | F3160500W1E | 1.694,93 | 2.285,41 | | | 2.876,92 | 3.002,39 |
| 525,0 | 549,0 | | | | | | | |
| 550,0 | 599,0 | F3160550W1E | 1.747,66 | 2.359,23 | | | 3.008,38 | 3.145,80 |
| 575,0 | 599,0 | | | | | | | |
| 600,0 | 649,0 | F3160600W1E | 1.803,03 | 2.433,04 | | | 3.160,76 | 3.313,13 |
| 650,0 | 699,0 | F3160650W1E | 1.861,04 | 2.512,13 | | | 3.232,44 | 3.396,75 |
| 700,0 | 749,0 | F3160700W1E | 1.908,46 | 2.575,36 | | | 3.304,14 | 3.480,38 |
| 750,0 | 799,0 | F3160750W1E | 4.797,85 | 5.374,48 | | | 3.381,80 | 3.570,02 |
| 800,0 | 849,0 | F3160800W1E | 4.905,43 | 5.493,98 | | | 3.465,46 | 3.662,64 |
| 850,0 | 899,0 | F3160850W1E | 5.018,94 | 5.619,43 | | | Consultar | Consultar |
| 900,0 | 949,0 | F3160900W1E | 5.123,51 | 5.738,92 | | | | |
| 950,0 | 999,0 | F3160950W1E | 5.237,01 | 5.864,38 | | | | |
| 1.000,0 | 1.049,0 | F3161000W1E | 5.350,55 | 5.989,87 | | | | |
| 1.050,0 | 1.099,0 | F3161050W1E | 5.464,10 | 6.121,31 | | | | |
| 1.100,0 | 1.149,0 | F3161100W1E | 5.568,62 | 6.237,84 | | | | |
| 1.150,0 | 1.199,0 | F3161150W1E | 5.682,17 | 6.366,29 | | | | |
| 1.200,0 | 1.249,0 | F3161200W1E | 5.798,68 | 6.491,76 | | | | |
| 1.250,0 | 1.299,0 | F3161250W1E | 5.912,22 | 6.620,24 | | | | |
| 1.300,0 | 1.349,0 | F3161300W1E | 6.016,76 | 6.739,73 | | | | |
| 1.350,0 | 1.399,0 | F3161350W1E | 6.130,29 | 6.865,19 | | | | |
| 1.400,0 | 1.449,0 | F3161400W1E | 6.243,82 | 6.990,68 | | | | |
| 1.450,0 | 1.499,0 | F3161450W1E | 6.354,34 | 7.116,15 | | | | |
| 1.500,0 | 1.549,0 | F3161500W1E | 6.467,90 | 7.244,61 | | | | |
| 1.550,0 | 1.599,0 | F3161550W1E | Consultar | Consultar | | | | |

Acoplamiento para tubos de cualquier material sin anclaje axial.

Acoplamiento de unión y compensador todo en uno.

Código W1 en NBR termina W1N

Código W2 en EPDM termina W2E

Código W5 en EPDM termina W5E

Código W2 en NBR termina W2N

Código W5 en NBR termina W5N

En caso de pedido indicar el diámetro exterior exacto.

Junta: EPDM: -20°C hasta +100°C NBR: -20°C hasta +80°C

Fluido: EPDM: Todas las calidades de agua, aguas residuales, aire, sólidos y diversos productos químicos.

NBR: Agua, gas, aceite, combustible y otros hidrocarburos.

Especificar 1 o 2 cierres

FLEX 3 PN 20

 Consultar

W1 CARCASA GALVANIZADA. CIERRES GALVANIZADOS

W5 CARCASA EN ACERO INOX. CIERRES EN ACERO INOX.

| desde Ø exterior | hasta Ø exterior | Ref. EPDM | € EPDM | Ref. NBR | € NBR | Ref. NBR | € NBR | Ref. NBR | € NBR |
|------------------|------------------|-------------|-----------|-------------|-----------|-------------|----------|-------------|-----------|
| 300,0 | 324,0 | | 0,00 | | 0,00 | F3200300W5E | 2.096,98 | F3200300W5N | 2.485,55 |
| 323,9 | 349,0 | F3200323W1E | 1.476,14 | F3200323W1N | 1.992,81 | | | | |
| 325,0 | 349,0 | | | | | F3200325W5E | 2.455,71 | F3200325W5N | 2.545,33 |
| 350,0 | 399,0 | F3200350W1E | 1.531,53 | F3200350W1N | 2.066,63 | F3200350W5E | 2.515,48 | F3200350W5N | 2.605,09 |
| 375,0 | 399,0 | | | | | F3200375W5E | 2.572,21 | F3200375W5N | 2.670,81 |
| 400,0 | 449,0 | F3200400W1E | 1.586,89 | F3200400W1N | 2.140,43 | F3200400W5E | 2.631,98 | F3200400W5N | 2.736,50 |
| 425,0 | 449,0 | | | | | F3200425W5E | 2.688,71 | F3200425W5N | 2.799,24 |
| 450,0 | 499,0 | F3200450W1E | 1.639,58 | F3200450W1N | 2.211,60 | F3200450W5E | 2.751,41 | F3200450W5N | 2.868,00 |
| 475,0 | 499,0 | | | | | F3200475W5E | 2.814,21 | F3200475W5N | 2.936,68 |
| 500,0 | 549,0 | F3200500W1E | 1.694,93 | F3200500W1N | 2.285,41 | F3200500W5E | 2.876,91 | F3200500W5N | 3.002,39 |
| 525,0 | 549,0 | | | | | F3200525W5E | 2.942,61 | F3200525W5N | 3.074,10 |
| 550,0 | 599,0 | F3200550W1E | 4.382,63 | F3200550W1N | 4.908,43 | F3200550W5E | 3.008,38 | F3200550W5N | 3.145,80 |
| 575,0 | 599,0 | | | | | F3200575W5E | 3.077,08 | F3200575W5N | 3.217,51 |
| 600,0 | 649,0 | F3200600W1E | 4.466,25 | F3200600W1N | 5.001,02 | F3200600W5E | 3.160,78 | F3200600W5N | 3.313,13 |
| 650,0 | 699,0 | F3200650W1E | 4.579,77 | F3200650W1N | 5.129,47 | F3200650W5E | Consulta | F3200650W5N | Consultar |
| 700,0 | 749,0 | F3200700W1E | 4.687,35 | F3200700W1N | 5.245,97 | | | | |
| 750,0 | 799,0 | F3200750W1E | 4.797,85 | F3200750W1N | 5.374,48 | | | | |
| 800,0 | 849,0 | F3200800W1E | 4.905,43 | F3200800W1N | 5.493,94 | | | | |
| 850,0 | 899,0 | F3200850W1E | 5.018,94 | F3200850W1N | 5.619,43 | | | | |
| 900,0 | 949,0 | F3200900W1E | 5.123,51 | F3200900W1N | 5.738,92 | | | | |
| 950,0 | 999,0 | F3200950W1E | 5.237,01 | F3200950W1N | 5.864,38 | | | | |
| 1.000,0 | 1.049,0 | F3201000W1E | 5.350,55 | F3201000W1N | 5.989,87 | | | | |
| 1.050,0 | 1.099,0 | F3201050W1E | 5.464,10 | F3201050W1N | 6.121,32 | | | | |
| 1.100,0 | 1.149,0 | F3201100W1E | 5.568,62 | F3201100W1N | 6.237,84 | | | | |
| 1.150,0 | 1.149,0 | F3201150W1E | Consultar | F3201150W1N | Consultar | | | | |

Acoplamiento para tubos

de cualquier material sin anclaje axial.

Acoplamiento de unión y compensador todo en uno.

En caso de pedido indicar el diámetro exterior exacto.

Junta: EPDM: -20°C hasta +100°C NBR: -20°C hasta +80°C

Fluido: EPDM: Todas las calidades de agua, aguas residuales, aire, sólidos y diversos productos químicos.

NBR: Agua, gas, aceite, combustible y otros hidrocarburos.

Especificar 1 o 2 cierres

FLEX 3 PN 25  PN  Consultar

W1 CARCASA GALVANIZADA. CIERRES GALVANIZADOS
W5 CARCASA EN ACERO INOX. CIERRES EN ACERO INOX.

| desde Ø exterior | hasta Ø exterior | Ref. EPDM | € EPDM | Ref. NBR | € NBR | Ref. NBR | € NBR | Ref. NBR | € NBR |
|------------------|------------------|-------------|-----------|-------------|-----------|-------------|-----------|-------------|-----------|
| 300,0 | 324,0 | | | | | F3250300W5E | 2.395,97 | F3250300W5N | 2.485,55 |
| 323,9 | 349,0 | F3250323W1E | 1.476,14 | F3250323W1N | 1.992,81 | F3250323W5E | 2.455,71 | F3250323W5N | 2.545,33 |
| 350,0 | 399,0 | F3250350W1E | 1.531,53 | F3250350W1N | 2.066,63 | F3250350W5E | 2.515,46 | F3250350W5N | 2.605,09 |
| 375,0 | 399,0 | | | | | F3250375W5E | 2.572,21 | F3250375W5N | 2.670,81 |
| 400,0 | 449,0 | F3250400W1E | 1.586,89 | F3250400W1N | 2.140,43 | F3250400W5E | 2.631,98 | F3250400W5N | 2.736,50 |
| 425,0 | 449,0 | | | | | F3250425W5E | 2.688,72 | F3250425W5N | 2.799,24 |
| 450,0 | 499,0 | F3250450W1E | 1.639,58 | F3250450W1N | 2.211,59 | F3250450W5E | 2.751,45 | F3250450W5N | 2.868,00 |
| 475,0 | 499,0 | | | | | F3250475W5E | 2.814,21 | F3250475W5N | 2.936,68 |
| 500,0 | 549,0 | | | | | F3250500W5E | Consultar | F3250500W5N | Consultar |
| 550,0 | 599,0 | F3250550W1E | 4.466,25 | F3250550W1N | 4.908,43 | | | | |
| 600,0 | 649,0 | F3250600W1E | 4.579,77 | F3250600W1N | 5.001,02 | | | | |
| 650,0 | 699,0 | F3250650W1E | 4.687,35 | F3250650W1N | 5.129,47 | | | | |
| 700,0 | 749,0 | F3250700W1E | 4.797,85 | F3250700W1N | 5.245,97 | | | | |
| 750,0 | 799,0 | F3250750W1E | 4.905,43 | F3250750W1N | 5.374,48 | | | | |
| 800,0 | 849,0 | F3250800W1E | 5.018,94 | F3250800W1N | 5.493,98 | | | | |
| 850,0 | 899,0 | F3250850W1E | 5.123,52 | F3250850W1N | 5.619,43 | | | | |
| 900,0 | 949,0 | F3250900W1E | 5.123,51 | F3250900W1N | 5.738,92 | | | | |
| 950,0 | 999,0 | F3250950W1E | Consultar | F3250950W1N | Consultar | | | | |



Acoplamiento para tubos de cualquier material sin anclaje axial.
 Acoplamiento de unión y compensador todo en uno.

En caso de pedido indicar el diámetro exterior exacto.
Junta: EPDM: -20°C hasta +100°C NBR: -20°C hasta +80°C
Fluido: EPDM: Todas las calidades de agua, aguas residuales, aire, sólidos y diversos productos químicos.
 NBR: Agua, gas, aceite, combustible y otros hidrocarburos.
 Especificar 1 o 2 cierres



OPEN FLEX 1

CARCASA EN ACERO GALVANIZADO

| diámetro exterior |  PN (bar) |  PN (bar) | Ref. EPDM | € EPDM | Ref. NBR | € NBR | Ref. FKM ⁽¹⁾ | € FKM |
|-------------------|--|--|-----------|--------|----------|--------|-------------------------|--------|
| 48,3 | 25,0 | 16,0 | 35001 | 129,97 | 35003 | 129,97 | 35009 | 212,06 |
| 54,0 | 25,0 | 16,0 | 35051 | 133,86 | 35053 | 133,86 | 35057 | 216,39 |
| 57,0 | 25,0 | 16,0 | 35101 | 136,04 | 35103 | 136,04 | 35106 | 220,91 |
| 60,3 | 25,0 | 16,0 | 35151 | 138,17 | 35153 | 138,17 | 35166 | 223,09 |
| 73,0 | 25,0 | 16,0 | 35201 | 150,30 | 35203 | 150,30 | 35213 | 251,23 |
| 76,1 | 25,0 | 16,0 | 35251 | 151,62 | 35253 | 151,62 | 35267 | 255,58 |
| 84,0 | 25,0 | 16,0 | 35301 | 155,08 | 35303 | 155,08 | 35309 | 262,06 |
| 88,9 | 25,0 | 16,0 | 35351 | 157,48 | 35353 | 157,48 | 35368 | 264,28 |
| 100,6 | 25,0 | 16,0 | 35401 | 161,82 | 35403 | 161,82 | 35411 | 270,73 |
| 101,6 | 25,0 | 16,0 | 35451 | 162,22 | 35453 | 162,22 | 35459 | 270,73 |
| 104,0 | 20,0 | 16,0 | 35501 | 162,65 | 35503 | 162,65 | 35514 | 272,93 |
| 104,8 | 20,0 | 16,0 | 35551 | 163,11 | 35553 | 163,11 | 35559 | 272,93 |
| 108,0 | 20,0 | 16,0 | 35601 | 164,84 | 35603 | 164,84 | 35614 | 275,07 |
| 114,3 | 20,0 | 16,0 | 35651 | 166,36 | 35653 | 166,36 | 35645 | 277,25 |
| 118,0 | 20,0 | 16,0 | 35671 | 167,43 | 35673 | 167,43 | 35636 | 294,56 |
| 127,0 | 20,0 | 16,0 | 35676 | 201,00 | 35678 | 201,00 | 35685 | 318,40 |
| 129,0 | 20,0 | 16,0 | 35701 | 202,07 | 35703 | 202,07 | 35709 | 320,55 |
| 130,2 | 20,0 | 16,0 | 35751 | 203,37 | 35753 | 203,37 | 35759 | 322,73 |
| 133,0 | 16,0 | 16,0 | 35801 | 205,99 | 35803 | 205,99 | 35814 | 324,87 |
| 139,7 | 16,0 | 16,0 | 35851 | 209,43 | 35853 | 209,43 | 35858 | 340,05 |
| 141,3 | 16,0 | 16,0 | 35901 | 209,88 | 35903 | 209,88 | 35912 | 342,22 |
| 154,0 | 16,0 | 16,0 | 35951 | 215,94 | 35953 | 215,94 | 35958 | 361,70 |
| 159,0 | 16,0 | 16,0 | 36001 | 218,73 | 36003 | 218,73 | 36016 | 370,40 |
| 168,3 | 16,0 | 16,0 | 36051 | 225,26 | 36053 | 225,26 | 36067 | 383,37 |



Acoplamiento abierto para tubos de cualquier material sin anclaje axial. Abierto con bisagra.

(1) acoplamiento con anillo interior en acero inoxidable incorporado.
Junta: EPDM: -20°C hasta +100°C NBR: -20°C hasta +80°C FKM: -20°C hasta +180°C
Fluido: EPDM: Todas las calidades de agua, aguas residuales, aire, sólidos y diversos productos químicos.
 NBR: Agua, gas, aceite, combustible y otros hidrocarburos.
 FKM: Ozono, oxígeno, ácidos, gas, aceite y carburantes.



OPEN FLEX 1

CARCARA EN ACERO INOXIDABLE

| diámetro exterior |  PN (bar) |  PN (bar) | Ref. EPDM | € EPDM | Ref. NBR | € NBR | Ref. FKM ⁽¹⁾ | € FKM |
|-------------------|--|--|-----------|--------|----------|--------|-------------------------|--------|
| 48,3 | 25,0 | 16,0 | 35000 | 164,40 | 35002 | 164,40 | 35007 | 244,74 |
| 54,0 | 25,0 | 16,0 | 35050 | 168,29 | 35052 | 168,29 | 35056 | 251,23 |
| 57,0 | 25,0 | 16,0 | 35100 | 169,59 | 35102 | 169,59 | 35108 | 253,42 |
| 60,3 | 25,0 | 16,0 | 35150 | 171,96 | 35152 | 171,96 | 35168 | 255,58 |
| 73,0 | 25,0 | 16,0 | 35200 | 184,95 | 35202 | 184,95 | 35209 | 288,06 |
| 76,1 | 25,0 | 16,0 | 35250 | 186,28 | 35252 | 186,28 | 35268 | 290,24 |
| 84,0 | 25,0 | 16,0 | 35300 | 189,72 | 35302 | 189,72 | 35308 | 294,56 |
| 88,9 | 25,0 | 16,0 | 35350 | 192,11 | 35352 | 192,11 | 35369 | 298,89 |
| 100,6 | 25,0 | 16,0 | 35400 | 196,24 | 35402 | 196,24 | 35410 | 303,22 |
| 101,6 | 25,0 | 16,0 | 35450 | 196,66 | 35452 | 196,66 | 35458 | 305,40 |
| 104,0 | 20,0 | 16,0 | 35500 | 197,34 | 35502 | 197,34 | 35515 | 305,40 |
| 104,8 | 20,0 | 16,0 | 35550 | 197,74 | 35552 | 197,74 | 35558 | 307,56 |
| 108,0 | 20,0 | 16,0 | 35600 | 199,03 | 35602 | 199,03 | 35609 | 309,73 |
| 114,3 | 20,0 | 16,0 | 35650 | 201,00 | 35652 | 201,00 | 35644 | 327,06 |
| 118,0 | 20,0 | 16,0 | 35670 | 202,07 | 35672 | 202,07 | 35635 | 311,89 |
| 127,0 | 20,0 | 16,0 | 35675 | 244,74 | 35677 | 244,74 | 35684 | 363,88 |
| 129,0 | 20,0 | 16,0 | 35700 | 246,89 | 35702 | 246,89 | 35708 | 366,03 |
| 130,2 | 20,0 | 16,0 | 35750 | 246,89 | 35752 | 246,89 | 35758 | 368,20 |
| 133,0 | 16,0 | 16,0 | 35800 | 249,10 | 35802 | 249,10 | 35813 | 370,40 |
| 139,7 | 16,0 | 16,0 | 35850 | 253,42 | 35852 | 253,42 | 35854 | 383,37 |
| 141,3 | 16,0 | 16,0 | 35900 | 253,42 | 35902 | 253,42 | 35911 | 383,37 |
| 154,0 | 16,0 | 16,0 | 35950 | 262,06 | 35952 | 262,06 | 35954 | 405,04 |
| 159,0 | 16,0 | 16,0 | 36000 | 266,42 | 36002 | 266,42 | 36015 | 415,87 |
| 168,3 | 16,0 | 16,0 | 36050 | 270,73 | 36052 | 270,73 | 36066 | 428,85 |

(1) acoplamiento con anillo interior en acero inoxidable incorporado.

Junta: EPDM: -20°C hasta +100°C NBR: -20°C hasta +80°C FKM: -20°C hasta +180°C

Fluido: EPDM: Todas las calidades de agua, aguas residuales, aire, sólidos y diversos productos químicos.

NBR: Agua, gas, aceite, combustible y otros hidrocarburos.

FKM: Ozono, oxígeno, ácidos, gas, aceite y carburantes.



OPEN FLEX 2 PN 2,5

| desde Ø exterior | hasta Ø exterior | Ref. EPDM | W1 CARCASA GALVANIZADA. CIERRES GALVANIZADOS | | | W2 CARCASA EN ACERO INOX. CIERRES GALVANIZADOS | | | W5 CARCASA EN ACERO INOX. CIERRES EN ACERO INOX. | | |
|------------------|------------------|--------------|---|----------|-----------|---|----------|-----------|---|----------|-----------|
| | | | € EPDM | € NBR | € FKM (1) | € EPDM | € NBR | € FKM (1) | € EPDM | € NBR | € FKM (1) |
| 172,0 | 199,0 | | | | | 611,56 | 611,56 | 819,80 | 695,91 | 695,91 | 904,15 |
| 200,0 | 224,0 | | | | | 632,65 | 632,65 | 875,16 | 717,00 | 717,00 | 959,51 |
| 225,0 | 249,0 | | | | | 645,82 | 645,82 | 930,51 | 730,17 | 730,17 | 1.014,87 |
| 250,0 | 274,0 | | | | | 664,26 | 664,26 | 988,53 | 748,62 | 748,62 | 1.072,82 |
| 275,0 | 299,0 | OF2020275W1E | 1.275,81 | 1.275,81 | 1.607,95 | 680,12 | 680,12 | 1.049,13 | 764,47 | 764,47 | 1.133,48 |
| 300,0 | 324,0 | OF2020300W1E | 1.296,89 | 1.296,89 | 1.676,52 | 701,20 | 701,20 | 1.104,50 | 785,53 | 785,53 | 1.188,83 |
| 325,0 | 349,0 | OF2020325W1E | 1.320,64 | 1.320,64 | 1.745,00 | 714,32 | 714,32 | 1.162,46 | 798,70 | 798,70 | 1.246,81 |
| 350,0 | 374,0 | OF2020350W1E | 1.341,70 | 1.341,70 | 1.808,30 | 735,44 | 735,44 | 1.225,75 | 819,83 | 819,83 | 1.310,08 |
| 375,0 | 399,0 | OF2020375W1E | 1.365,45 | 1.365,45 | 1.882,10 | 748,62 | 748,62 | 1.278,46 | 832,95 | 832,95 | 1.362,81 |
| 400,0 | 424,0 | OF2020400W1E | 1.386,50 | 1.386,50 | 1.950,66 | 761,80 | 761,80 | 1.336,43 | 846,15 | 846,15 | 1.420,78 |
| 425,0 | 449,0 | OF2020425W1E | 1.412,91 | 1.412,91 | 2.011,28 | 790,81 | 790,81 | 1.399,73 | 875,15 | 875,15 | 1.484,08 |
| 450,0 | 474,0 | OF2020450W1E | 1.433,96 | 1.433,96 | 2.074,55 | 806,64 | 806,64 | 1.455,07 | 890,98 | 890,98 | 1.539,42 |
| 475,0 | 499,0 | OF2020475W1E | 1.455,07 | 1.455,07 | 2.135,16 | 830,36 | 830,36 | 1.515,69 | 914,71 | 914,71 | 1.600,04 |
| 500,0 | 524,0 | OF2020500W1E | 1.476,14 | 1.476,14 | 2.198,43 | 851,45 | 851,45 | 1.573,69 | 935,79 | 935,79 | 1.658,05 |
| 525,0 | 549,0 | OF2020525W1E | 1.507,81 | 1.507,81 | 2.266,95 | 880,43 | 880,43 | 1.639,58 | 964,78 | 964,78 | 1.723,95 |
| 550,0 | 574,0 | OF2020550W1E | 1.549,98 | 1.549,98 | 2.353,96 | 896,27 | 896,27 | 1.697,58 | 980,61 | 980,61 | 1.781,94 |
| 575,0 | 599,0 | OF2020575W1E | 1.581,62 | 1.581,62 | 2.425,11 | 919,97 | 919,97 | 1.752,97 | 1.004,32 | 1.004,32 | 1.837,30 |
| 600,0 | 624,0 | OF2020600W1E | 1.676,52 | 1.676,52 | 2.517,40 | 1.064,97 | 1.064,97 | 1.911,09 | 1.149,31 | 1.149,31 | 1.995,46 |
| 625,0 | 649,0 | OF2020625W1E | 1.708,13 | 1.708,13 | 2.599,11 | 1.093,97 | 1.093,97 | 1.990,20 | 1.178,30 | 1.178,30 | 2.074,55 |
| 650,0 | 674,0 | OF2020650W1E | 1.745,00 | 1.745,00 | 2.675,54 | 1.120,30 | 1.120,30 | 2.053,44 | 1.204,66 | 1.204,66 | 2.137,79 |
| 675,0 | 699,0 | OF2020675W1E | 1.779,28 | 1.779,28 | 2.741,47 | 1.154,57 | 1.154,57 | 2.116,71 | 1.238,94 | 1.238,94 | 2.201,06 |
| 700,0 | 724,0 | OF2020700W1E | 1.816,23 | 1.816,23 | 2.817,88 | 1.175,64 | 1.175,64 | 2.174,70 | 1.260,01 | 1.260,01 | 2.259,07 |
| 725,0 | 749,0 | OF2020725W1E | 1.850,50 | 1.850,50 | 2.889,05 | 1.207,26 | 1.207,26 | 2.237,95 | 1.291,64 | 1.291,64 | 2.322,32 |
| 750,0 | 799,0 | OF2020750W1E | 1.879,46 | 1.879,46 | 2.931,24 | 1.433,96 | 1.433,96 | 2.382,98 | 1.518,33 | 1.518,33 | 2.467,31 |
| 800,0 | 849,0 | OF2020800W1E | 1.955,91 | 1.955,91 | 3.018,23 | 1.484,08 | 1.484,08 | 2.509,48 | 1.568,42 | 1.568,42 | 2.593,84 |

Acoplamiento abierto para tubos de cualquier material sin anclaje axial.

Abierto con bisagra.

Código W1 en NBR termina W1N
Código W1 en FKM termina W1F

Código W2 en EPDM termina W2E
Código W2 en NBR termina W2N
Código W2 en FKM termina W2F

Código W5 en EPDM termina W5E
Código W5 en NBR termina W5N
Código W5 en FKM termina W5F

Continúa en la página siguiente...

| desde Ø exterior | hasta Ø exterior | Ref. EPDM | W1 CARCASA GALVANIZADA. CIERRES GALVANIZADOS | | | W2 CARCASA EN ACERO INOX. CIERRES GALVANIZADOS | | | W5 CARCASA EN ACERO INOX. CIERRES EN ACERO INOX. | | |
|------------------|------------------|--------------|---|----------|--------------|---|----------|--------------|---|----------|--------------|
| | | | € EPDM | € NBR | € FKM (1) | € EPDM | € NBR | € FKM (1) | € EPDM | € NBR | € FKM (1) |
| 850,0 | 899,0 | OF2020850W1E | 2.024,46 | 2.024,46 | 3.102,57 | 1.536,81 | 1.536,81 | 2.630,72 | 1.621,16 | 1.621,16 | 2.715,08 |
| 900,0 | 949,0 | OF2020900W1E | 2.092,96 | 2.092,96 | 3.244,94 | 1.592,16 | 1.592,16 | 2.754,61 | 1.676,52 | 1.676,52 | 2.838,96 |
| 950,0 | 999,0 | OF2020950W1E | 2.164,16 | 2.164,16 | 3.395,19 | 1.642,24 | 1.642,24 | 2.878,51 | 1.726,59 | 1.726,59 | 2.962,86 |
| 1.000,0 | 1.049,0 | OF2021000W1E | 2.232,69 | 2.232,69 | 3.534,87 | 1.700,21 | 1.700,21 | 3.002,39 | 1.784,57 | 1.784,57 | 3.086,75 |
| 1.050,0 | 1.099,0 | OF2021050W1E | 2.311,78 | 2.311,78 | 3.674,59 | 1.771,42 | 1.771,42 | 3.131,57 | 1.855,77 | 1.855,77 | 3.215,93 |
| 1.100,0 | 1.149,0 | OF2021100W1E | 2.372,38 | 2.372,38 | 3.790,55 | 1.847,83 | 1.847,83 | 3.266,00 | 1.932,20 | 1.932,20 | 3.350,37 |
| 1.150,0 | 1.199,0 | OF2021150W1E | 2.443,58 | 2.443,58 | 3.919,72 | 1.921,66 | 1.921,66 | 3.395,19 | 2.006,01 | 2.006,01 | 3.479,55 |
| 1.200,0 | 1.249,0 | OF2021200W1E | 2.514,76 | 2.514,76 | 4.051,56 | 1.995,46 | 1.995,46 | 3.524,35 | 2.079,81 | 2.079,81 | 3.608,70 |
| 1.250,0 | 1.299,0 | OF2021250W1E | 2.585,92 | 2.585,92 | 4.180,72 | 2.069,27 | 2.069,27 | 3.656,11 | 2.153,61 | 2.153,61 | 3.740,47 |
| 1.300,0 | 1.349,0 | OF2021300W1E | 2.654,45 | 2.654,45 | 4.312,49 | 2.143,07 | 2.143,07 | 3.787,95 | 2.227,41 | 2.227,41 | 3.872,30 |
| 1.350,0 | 1.399,0 | OF2021350W1E | 2.725,61 | 2.725,61 | 4.441,66 | 2.214,28 | 2.214,28 | 3.917,12 | 2.298,62 | 2.298,62 | 4.001,46 |
| 1.400,0 | 1.449,0 | OF2021400W1E | 2.796,81 | 2.796,81 | 4.576,11 | 2.288,07 | 2.288,07 | 4.048,89 | 2.372,38 | 2.372,38 | 4.133,26 |
| 1.450,0 | 1.499,0 | OF2021450W1E | 2.868,00 | 2.868,00 | 4.705,27 | 2.361,84 | 2.361,84 | 4.180,72 | 2.446,20 | 2.446,20 | 4.265,08 |
| 1.500,0 | 1.549,0 | OF2021500W1E | 2.936,50 | 2.936,50 | 4.834,45 | 3.049,87 | 3.049,87 | 4.947,78 | 3.139,48 | 3.139,48 | 5.037,41 |
| 1.550,0 | 1.600,0 | OF2021550W1E | 3.007,68 | 3.007,68 | 4.966,20 | 3.142,09 | 3.142,09 | 5.098,03 | 3.231,73 | 3.231,73 | 5.187,66 |
| 1.600,0 | 1.649,0 | OF2021600W1E | 3.078,84 | 3.078,84 | 5.095,38 | 3.234,40 | 3.234,40 | 5.250,93 | 3.324,00 | 3.324,00 | 5.340,54 |
| 1.650,0 | 1.699,0 | OF2021650W1E | 3.150,05 | 3.150,05 | 5.227,19 | 3.326,62 | 3.326,62 | 5.403,79 | 3.416,26 | 3.416,26 | 5.493,41 |
| 1.700,0 | 1.749,0 | OF2021700W1E | 3.221,19 | 3.221,19 | 5.356,37 | 3.418,91 | 3.418,91 | 5.554,04 | 3.508,55 | 3.508,55 | 5.643,67 |
| 1.750,0 | 1.799,0 | OF2021750W1E | 3.289,73 | 3.289,73 | 5.488,15 | 3.511,15 | 3.511,15 | 5.706,95 | 3.600,77 | 3.600,77 | 5.796,59 |
| 1.800,0 | 1.849,0 | OF2021800W1E | 3.360,91 | 3.360,91 | 5.617,32 | 3.603,42 | 3.603,42 | 5.859,83 | 3.693,05 | 3.693,05 | 5.949,46 |
| 1.850,0 | 1.899,0 | OF2021850W1E | 3.432,07 | 3.432,07 | 5.749,14 | 3.695,69 | 3.695,69 | 6.010,08 | 3.785,28 | 3.785,28 | 6.099,71 |
| 1.900,0 | 1.949,0 | OF2021900W1E | 3.503,26 | 3.503,26 | 5.878,29 | 3.787,95 | 3.787,95 | 6.162,99 | 3.877,58 | 3.877,58 | 6.252,59 |
| 1.950,0 | 1.999,0 | OF2021950W1E | 3.571,77 | 3.571,77 | 6.007,48 | 3.880,17 | 3.880,17 | 6.315,85 | 3.969,82 | 3.969,82 | 6.405,46 |
| 2.000,0 | 2.032,0 | OF2022000W1E | 3.642,98 | 3.642,98 | 6.139,26 | 3.972,45 | 3.972,45 | 6.466,11 | 4.062,09 | 4.062,09 | 6.555,73 |

Código W1 en NBR termina W1N
Código W1 en FKM termina W1F

Código W2 en EPDM termina W2E
Código W2 en NBR termina W2N
Código W2 en FKM termina W2F

Código W5 en EPDM termina W5E
Código W5 en NBR termina W5N
Código W5 en FKM termina W5F

(1) acoplamiento con anillo interior en acero inoxidable incorporado.

Junta: EPDM: -20°C hasta +100°C NBR: -20°C hasta +80°C FKM: -20°C hasta +180°C

Fluido: EPDM: Todas las calidades de agua, aguas residuales, aire, sólidos y diversos productos químicos.

NBR: Agua, gas, aceite, combustible y otros hidrocarburos.

FKM: Ozono, oxígeno, ácidos, gas, aceite y carburantes.

Especificar 1 o 2 cierres



OPEN FLEX 2 PN 6

| desde Ø exterior | hasta Ø exterior | Ref. EPDM | W1 CARCASA GALVANIZADA. CIERRES GALVANIZADOS | | | W2 CARCASA EN ACERO INOX. CIERRES GALVANIZADOS | | | W5 CARCASA EN ACERO INOX. CIERRES EN ACERO INOX. | | |
|------------------|------------------|--------------|---|----------|-----------|---|----------|-----------|---|----------|-----------|
| | | | € EPDM | € NBR | € FKM (1) | € EPDM | € NBR | € FKM (1) | € EPDM | € NBR | € FKM (1) |
| 172,0 | 199,0 | | | | | 611,56 | 611,56 | 819,80 | 695,91 | 695,91 | 904,15 |
| 200,0 | 224,0 | | | | | 632,65 | 632,65 | 875,16 | 717,00 | 717,00 | 959,51 |
| 225,0 | 249,0 | | | | | 645,82 | 645,82 | 930,51 | 730,17 | 730,17 | 1.014,87 |
| 250,0 | 274,0 | | | | | 664,26 | 664,26 | 988,53 | 748,62 | 748,62 | 1.072,82 |
| 275,0 | 299,0 | OF2060275W1E | 1.275,81 | 1.275,81 | 1.607,95 | 680,12 | 680,12 | 1.049,13 | 764,47 | 764,47 | 1.133,48 |
| 300,0 | 324,0 | OF2060300W1E | 1.296,89 | 1.296,89 | 1.676,52 | 701,20 | 701,20 | 1.104,50 | 785,53 | 785,53 | 1.188,83 |
| 325,0 | 349,0 | OF2060325W1E | 1.320,64 | 1.320,64 | 1.745,00 | 714,32 | 714,32 | 1.162,46 | 798,70 | 798,70 | 1.246,81 |
| 350,0 | 374,0 | OF2060350W1E | 1.341,70 | 1.341,70 | 1.808,30 | 735,44 | 735,44 | 1.225,75 | 819,83 | 819,83 | 1.310,08 |
| 375,0 | 399,0 | OF2060375W1E | 1.365,45 | 1.365,45 | 1.882,10 | 748,62 | 748,62 | 1.278,46 | 832,95 | 832,95 | 1.362,81 |
| 400,0 | 424,0 | OF2060400W1E | 1.386,50 | 1.386,50 | 1.950,66 | 761,80 | 761,80 | 1.336,43 | 846,15 | 846,15 | 1.420,78 |
| 425,0 | 449,0 | OF2060425W1E | 1.412,91 | 1.412,91 | 2.011,28 | 790,81 | 790,81 | 1.399,73 | 875,15 | 875,15 | 1.484,08 |
| 450,0 | 474,0 | OF2060450W1E | 1.433,96 | 1.433,96 | 2.074,55 | 806,64 | 806,64 | 1.455,07 | 890,98 | 890,98 | 1.539,42 |
| 475,0 | 499,0 | OF2060475W1E | 1.455,07 | 1.455,07 | 2.135,16 | 830,36 | 830,36 | 1.515,69 | 914,71 | 914,71 | 1.600,04 |
| 500,0 | 524,0 | OF2060500W1E | 1.476,14 | 1.476,14 | 2.198,43 | 851,45 | 851,45 | 1.573,69 | 935,79 | 935,79 | 1.658,05 |
| 525,0 | 549,0 | OF2060525W1E | 1.507,81 | 1.507,81 | 2.266,95 | 946,32 | 946,32 | 1.718,67 | 1.030,67 | 1.030,67 | 1.803,03 |
| 550,0 | 574,0 | OF2060550W1E | 1.549,98 | 1.549,98 | 2.353,96 | 970,08 | 970,08 | 1.779,28 | 1.054,41 | 1.054,41 | 1.863,64 |
| 575,0 | 599,0 | OF2060575W1E | 1.581,62 | 1.581,62 | 2.425,11 | 993,78 | 993,78 | 1.837,30 | 1.078,15 | 1.078,15 | 1.921,66 |
| 600,0 | 624,0 | OF2060600W1E | 1.676,52 | 1.676,52 | 2.517,40 | 1.331,16 | 1.331,16 | 2.172,07 | 1.420,78 | 1.420,78 | 2.261,65 |
| 625,0 | 649,0 | OF2060625W1E | 1.708,13 | 1.708,13 | 2.599,11 | 1.368,10 | 1.368,10 | 2.259,07 | 1.457,71 | 1.457,71 | 2.348,67 |
| 650,0 | 674,0 | OF2060650W1E | 1.745,00 | 1.745,00 | 2.675,54 | 1.399,73 | 1.399,73 | 2.330,23 | 1.489,34 | 1.489,34 | 2.419,85 |
| 675,0 | 699,0 | OF2060675W1E | 1.779,28 | 1.779,28 | 2.741,47 | 1.441,91 | 1.441,91 | 2.406,67 | 1.531,53 | 1.531,53 | 2.496,27 |
| 700,0 | 724,0 | OF2060700W1E | 1.816,23 | 1.816,23 | 2.817,88 | 1.470,86 | 1.470,86 | 2.472,59 | 1.560,51 | 1.560,51 | 2.562,22 |
| 725,0 | 749,0 | OF2060725W1E | 1.850,50 | 1.850,50 | 2.889,05 | 1.513,07 | 1.513,07 | 2.549,00 | 1.602,70 | 1.602,70 | 2.638,65 |
| 750,0 | 799,0 | OF2060750W1E | 1.879,46 | 1.879,46 | 2.931,24 | 1.789,83 | 1.789,83 | 2.712,46 | 1.879,46 | 1.879,46 | 2.802,09 |
| 800,0 | 849,0 | OF2060800W1E | 1.955,91 | 1.955,91 | 3.018,23 | 1.853,09 | 1.853,09 | 2.857,43 | 1.942,72 | 1.942,72 | 2.947,05 |

Acoplamiento abierto para tubos de cualquier material sin anclaje axial.

Abierto con bisagra.

Código W1 en NBR termina W1N
Código W1 en FKM termina W1F

Código W2 en EPDM termina W2E
Código W2 en NBR termina W2N
Código W2 en FKM termina W2F

Código W5 en EPDM termina W5E
Código W5 en NBR termina W5N
Código W5 en FKM termina W5F

Continúa en la página siguiente...

| desde Ø exterior | hasta Ø exterior | Ref. EPDM | W1 CARCASA GALVANIZADA. CIERRES GALVANIZADOS | | | W2 CARCASA EN ACERO INOX. CIERRES GALVANIZADOS | | | W5 CARCASA EN ACERO INOX. CIERRES EN ACERO INOX. | | |
|------------------|------------------|--------------|---|----------|--------------|---|----------|--------------|---|----------|--------------|
| | | | € EPDM | € NBR | € FKM (1) | € EPDM | € NBR | € FKM (1) | € EPDM | € NBR | € FKM (1) |
| 850,0 | 899,0 | OF2060850W1E | 2.024,46 | 2.024,46 | 3.102,57 | 1.918,99 | 1.918,99 | 2.997,15 | 2.008,62 | 2.008,62 | 3.086,75 |
| 900,0 | 949,0 | OF2060900W1E | 2.092,96 | 2.092,96 | 3.244,94 | 1.990,20 | 1.990,20 | 3.142,09 | 2.079,81 | 2.079,81 | 3.231,73 |
| 950,0 | 999,0 | OF2060950W1E | 2.164,16 | 2.164,16 | 3.395,19 | 2.056,08 | 2.056,08 | 3.284,47 | 2.145,70 | 2.145,70 | 3.374,10 |
| 1.000,0 | 1.049,0 | OF2061000W1E | 2.232,69 | 2.232,69 | 3.534,87 | 2.121,96 | 2.121,96 | 3.426,81 | 2.211,59 | 2.211,59 | 3.516,41 |
| 1.050,0 | 1.099,0 | OF2061050W1E | 2.311,78 | 2.311,78 | 3.674,59 | 2.211,59 | 2.211,59 | 3.577,04 | 2.301,22 | 2.301,22 | 3.666,66 |
| 1.100,0 | 1.149,0 | OF2061100W1E | 2.372,38 | 2.372,38 | 3.790,55 | 2.311,78 | 2.311,78 | 3.727,32 | 2.401,38 | 2.401,38 | 3.816,94 |
| 1.150,0 | 1.199,0 | OF2061150W1E | 2.443,58 | 2.443,58 | 3.919,72 | 2.404,04 | 2.404,04 | 3.880,17 | 2.493,67 | 2.493,67 | 3.969,82 |
| 1.200,0 | 1.249,0 | OF2061200W1E | 2.514,76 | 2.514,76 | 4.051,56 | | | | 3.456,52 | 3.456,52 | 6.303,54 |
| 1.250,0 | 1.299,0 | OF2061250W1E | 2.585,92 | 2.585,92 | 4.180,72 | | | | 3.540,15 | 3.540,15 | 6.488,80 |
| 1.300,0 | 1.349,0 | OF2061300W1E | 2.654,45 | 2.654,45 | 4.312,49 | | | | 3.623,78 | 3.623,78 | 6.674,02 |
| 1.350,0 | 1.399,0 | OF2061350W1E | 2.725,61 | 2.725,61 | 4.441,66 | | | | 3.710,42 | 3.710,42 | 6.862,22 |
| 1.400,0 | 1.449,0 | OF2061400W1E | 2.796,81 | 2.796,81 | 4.576,11 | | | | 3.800,05 | 3.800,05 | 7.050,44 |
| 1.450,0 | 1.499,0 | OF2061450W1E | 2.868,00 | 2.868,00 | 4.705,27 | | | | 3.892,66 | 3.892,66 | 7.241,64 |
| 1.500,0 | 1.549,0 | OF2061500W1E | 2.936,50 | 2.936,50 | 4.834,45 | | | | 3.985,30 | 3.985,30 | 7.438,80 |
| 1.550,0 | 1.600,0 | OF2061550W1E | 3.007,68 | 3.007,68 | 4.966,20 | | | | 4.080,87 | 4.080,87 | 7.629,98 |
| 1.600,0 | 1.649,0 | OF2061600W1E | 3.078,84 | 3.078,84 | 5.095,38 | | | | 4.179,47 | 4.179,47 | 7.830,16 |
| 1.650,0 | 1.699,0 | OF2061650W1E | 3.150,05 | 3.150,05 | 5.227,19 | | | | 4.281,06 | 4.281,06 | 8.033,30 |
| 1.700,0 | 1.749,0 | OF2061700W1E | 3.221,19 | 3.221,19 | 5.356,37 | | | | 4.636,55 | 4.636,55 | 8.490,38 |
| 1.750,0 | 1.799,0 | OF2061750W1E | 3.289,73 | 3.289,73 | 5.488,15 | | | | 4.753,05 | 4.753,05 | 8.705,48 |
| 1.800,0 | 1.849,0 | OF2061800W1E | 3.360,91 | 3.360,91 | 5.617,32 | | | | 4.869,58 | 4.869,58 | 8.923,58 |
| 1.850,0 | 1.899,0 | OF2061850W1E | 3.432,07 | 3.432,07 | 5.749,14 | | | | 4.995,03 | 4.995,03 | 9.144,61 |
| 1.900,0 | 1.949,0 | OF2061900W1E | 4.475,94 | 4.475,94 | 6.853,58 | | | | 5.117,52 | 5.117,52 | 9.371,71 |
| 1.950,0 | 1.999,0 | OF2061950W1E | 4.565,58 | 4.565,58 | 7.001,22 | | | | 5.245,97 | 5.245,97 | 9.601,69 |
| 2.000,0 | 2.032,0 | OF2062000W1E | 4.655,18 | 4.655,18 | 7.151,47 | | | | 5.377,44 | 5.377,44 | 9.831,77 |

Código W1 en NBR termina W1N
Código W1 en FKM termina W1F

Código W2 en EPDM termina W2E
Código W2 en NBR termina W2N
Código W2 en FKM termina W2F

Código W5 en EPDM termina W5E
Código W5 en NBR termina W5N
Código W5 en FKM termina W5F

(1) acoplamiento con anillo interior en acero inoxidable incorporado.

Junta: EPDM: -20°C hasta +100°C NBR: -20°C hasta +80°C FKM: -20°C hasta +180°C

Fluido: EPDM: Todas las calidades de agua, aguas residuales, aire, sólidos y diversos productos químicos.

NBR: Agua, gas, aceite, combustible y otros hidrocarburos.

FKM: Ozono, oxígeno, ácidos, gas, aceite y carburantes.

Especificar 1 o 2 cierres



OPEN FLEX 2 PN 10

| desde Ø exterior | hasta Ø exterior | Ref. EPDM | W1 CARCASA GALVANIZADA. CIERRES GALVANIZADOS | | | W2 CARCASA EN ACERO INOX. CIERRES GALVANIZADOS | | | W5 CARCASA EN ACERO INOX. CIERRES EN ACERO INOX. | | |
|------------------|------------------|--------------|---|----------|-----------|---|----------|-----------|---|----------|-----------|
| | | | € EPDM | € NBR | € FKM (1) | € EPDM | € NBR | € FKM (1) | € EPDM | € NBR | € FKM (1) |
| 172,0 | 199,0 | | | | | 611,56 | 611,56 | 819,80 | 695,91 | 695,91 | 904,15 |
| 200,0 | 224,0 | | | | | 632,65 | 632,65 | 875,16 | 717,00 | 717,00 | 959,51 |
| 225,0 | 249,0 | | | | | 645,82 | 645,82 | 930,51 | 730,17 | 730,17 | 1.014,87 |
| 250,0 | 274,0 | | | | | 664,26 | 664,26 | 988,53 | 748,62 | 748,62 | 1.072,82 |
| 275,0 | 299,0 | OF2100275W1E | 1.275,81 | 1.275,81 | 1.607,95 | 732,80 | 732,80 | 1.112,36 | 817,15 | 817,15 | 1.196,75 |
| 300,0 | 324,0 | OF2100300W1E | 1.296,89 | 1.296,89 | 1.676,52 | 756,53 | 756,53 | 1.178,30 | 840,89 | 840,89 | 1.262,66 |
| 325,0 | 349,0 | OF2100325W1E | 1.320,64 | 1.320,64 | 1.745,00 | 772,35 | 772,35 | 1.233,66 | 856,69 | 856,69 | 1.318,01 |
| 350,0 | 374,0 | OF2100350W1E | 1.341,70 | 1.341,70 | 1.808,30 | 993,78 | 993,78 | 1.460,34 | 1.083,40 | 1.083,40 | 1.549,98 |
| 375,0 | 399,0 | OF2100375W1E | 1.365,45 | 1.365,45 | 1.882,10 | 1.012,23 | 1.012,23 | 1.528,89 | 1.101,83 | 1.101,83 | 1.618,51 |
| 400,0 | 424,0 | OF2100400W1E | 1.386,50 | 1.386,50 | 1.950,66 | 1.030,67 | 1.030,67 | 1.594,75 | 1.120,30 | 1.120,30 | 1.684,39 |
| 425,0 | 449,0 | OF2100425W1E | 1.412,91 | 1.412,91 | 2.011,28 | 1.064,97 | 1.064,97 | 1.663,32 | 1.154,57 | 1.154,57 | 1.752,97 |
| 450,0 | 474,0 | OF2100450W1E | 1.433,96 | 1.433,96 | 2.074,55 | 1.088,70 | 1.088,70 | 1.729,21 | 1.178,30 | 1.178,30 | 1.818,83 |
| 475,0 | 499,0 | OF2100475W1E | 1.455,07 | 1.455,07 | 2.135,16 | 1.122,96 | 1.122,96 | 1.803,03 | 1.212,56 | 1.212,56 | 1.892,66 |
| 500,0 | 524,0 | OF2100500W1E | 1.476,14 | 1.476,14 | 2.198,43 | 1.151,94 | 1.151,94 | 1.874,19 | 1.241,55 | 1.241,55 | 1.963,81 |
| 525,0 | 549,0 | OF2100525W1E | 1.507,81 | 1.507,81 | 2.266,95 | 1.186,19 | 1.186,19 | 1.947,98 | 1.275,81 | 1.275,81 | 2.037,63 |
| 550,0 | 574,0 | OF2100550W1E | 1.549,98 | 1.549,98 | 2.353,96 | 1.215,20 | 1.215,20 | 2.019,19 | 1.304,81 | 1.304,81 | 2.108,82 |
| 575,0 | 599,0 | OF2100575W1E | 1.581,62 | 1.581,62 | 2.425,11 | 1.244,20 | 1.244,20 | 2.085,09 | 1.333,85 | 1.333,85 | 2.174,70 |
| 600,0 | 624,0 | OF2100600W1E | 1.676,52 | 1.676,52 | 2.517,40 | 1.331,16 | 1.331,16 | 2.172,07 | 1.420,78 | 1.420,78 | 2.261,65 |
| 625,0 | 649,0 | OF2100625W1E | 1.708,13 | 1.708,13 | 2.599,11 | 1.368,10 | 1.368,10 | 2.259,07 | 1.457,71 | 1.457,71 | 2.348,67 |
| 650,0 | 674,0 | OF2100650W1E | 1.745,00 | 1.745,00 | 2.675,54 | 1.399,73 | 1.399,73 | 2.330,23 | 1.489,34 | 1.489,34 | 2.419,85 |
| 675,0 | 699,0 | OF2100675W1E | 1.779,28 | 1.779,28 | 2.741,47 | 1.441,91 | 1.441,91 | 2.406,67 | 1.531,53 | 1.531,53 | 2.496,27 |
| 700,0 | 724,0 | OF2100700W1E | 1.816,23 | 1.816,23 | 2.817,88 | 1.470,86 | 1.470,86 | 2.472,59 | 1.560,51 | 1.560,51 | 2.562,22 |
| 725,0 | 749,0 | OF2100725W1E | 1.850,50 | 1.850,50 | 2.889,05 | | | | 2.891,89 | 2.891,89 | 4.738,13 |
| 750,0 | 799,0 | OF2100750W1E | 1.879,46 | 1.879,46 | 2.931,24 | | | | 2.939,65 | 2.939,65 | 4.884,51 |
| 800,0 | 849,0 | OF2100800W1E | 1.955,91 | 1.955,91 | 3.018,23 | | | | 2.984,48 | 2.984,48 | 5.030,88 |

Acoplamiento abierto para tubos de cualquier material sin anclaje axial.

Abierto con bisagra.

Código W1 en NBR termina W1N
Código W1 en FKM termina W1F

Código W2 en EPDM termina W2E
Código W2 en NBR termina W2N
Código W2 en FKM termina W2F

Código W5 en EPDM termina W5E
Código W5 en NBR termina W5N
Código W5 en FKM termina W5F

Continúa en la página siguiente...

| desde Ø exterior | hasta Ø exterior | Ref. EPDM | W1 CARCASA GALVANIZADA. CIERRES GALVANIZADOS | | | W2 CARCASA EN ACERO INOX. CIERRES GALVANIZADOS | | | W5 CARCASA EN ACERO INOX. CIERRES EN ACERO INOX. | | | | |
|------------------|------------------|--------------|---|----------|-----------|---|-------|-----------|---|-------|-----------|----------|----------|
| | | | € EPDM | € NBR | € FKM (1) | € EPDM | € NBR | € FKM (1) | € EPDM | € NBR | € FKM (1) | | |
| 850,0 | 899,0 | OF2100850W1E | 2.024,46 | 2.024,46 | 3.102,57 | | | | | | 3.020,33 | 3.020,33 | 5.168,35 |
| 900,0 | 949,0 | OF2100900W1E | 2.092,96 | 2.092,96 | 3.244,94 | | | | | | 3.083,08 | 3.083,08 | 5.329,65 |
| 950,0 | 999,0 | OF2100950W1E | 2.164,16 | 2.164,16 | 3.395,19 | | | | | | 3.124,92 | 3.124,92 | 5.473,06 |
| 1.000,0 | 1.049,0 | OF2101000W1E | 2.862,70 | 2.862,70 | 4.164,87 | | | | | | 3.166,71 | 3.166,71 | 5.616,45 |
| 1.050,0 | 1.099,0 | OF2101050W1E | 2.962,86 | 2.962,86 | 4.325,69 | | | | | | 3.208,53 | 3.208,53 | 5.756,85 |
| 1.100,0 | 1.149,0 | OF2101100W1E | 3.044,54 | 3.044,54 | 4.460,12 | | | | | | 3.295,19 | 3.295,19 | 5.945,05 |
| 1.150,0 | 1.199,0 | OF2101150W1E | 3.134,19 | 3.134,19 | 4.610,38 | | | | | | 3.381,80 | 3.381,80 | 6.133,26 |
| 1.200,0 | 1.249,0 | OF2101200W1E | 3.223,81 | 3.223,81 | 4.760,62 | | | | | | | | |
| 1.250,0 | 1.299,0 | OF2101250W1E | 3.313,42 | 3.313,42 | 4.908,25 | | | | | | | | |
| 1.300,0 | 1.349,0 | OF2101300W1E | 3.403,05 | 3.403,05 | 5.058,49 | | | | | | | | |
| 1.350,0 | 1.399,0 | OF2101350W1E | 3.492,69 | 3.492,69 | 5.208,74 | | | | | | | | |
| 1.400,0 | 1.449,0 | OF2101400W1E | 3.582,30 | 3.582,30 | 5.359,00 | | | | | | | | |
| 1.450,0 | 1.499,0 | OF2101450W1E | 3.671,94 | 3.671,94 | 5.509,25 | | | | | | | | |
| 1.500,0 | 1.549,0 | OF2101500W1E | 3.761,57 | 3.761,57 | 5.659,52 | | | | | | | | |
| 1.550,0 | 1.600,0 | OF2101550W1E | 3.851,19 | 3.851,19 | 5.807,09 | | | | | | | | |
| 1.600,0 | 1.649,0 | OF2101600W1E | 3.940,82 | 3.940,82 | 5.957,34 | | | | | | | | |
| 1.650,0 | 1.699,0 | OF2101650W1E | 4.030,42 | 4.030,42 | 6.104,99 | | | | | | | | |
| 1.700,0 | 1.749,0 | OF2101700W1E | 4.120,07 | 4.120,07 | 6.255,21 | | | | | | | | |
| 1.750,0 | 1.799,0 | OF2101750W1E | 4.209,70 | 4.209,70 | 6.405,46 | | | | | | | | |
| 1.800,0 | 1.849,0 | OF2101800W1E | 4.296,70 | 4.296,70 | 6.553,09 | | | | | | | | |
| 1.850,0 | 1.899,0 | OF2101850W1E | 4.386,30 | 4.386,30 | 6.703,34 | | | | | | | | |
| 1.900,0 | 1.949,0 | OF2101900W1E | 4.475,94 | 4.475,94 | 6.853,58 | | | | | | | | |
| 1.950,0 | 1.999,0 | OF2101950W1E | 4.565,58 | 4.565,58 | 7.001,22 | | | | | | | | |
| 2.000,0 | 2.032,0 | OF2102000W1E | 4.655,18 | 4.655,18 | 7.151,47 | | | | | | | | |

Código W1 en NBR termina W1N
Código W1 en FKM termina W1F

Código W5 en EPDM termina W5E
Código W5 en NBR termina W5N
Código W5 en FKM termina W5F

(1) acoplamiento con anillo interior en acero inoxidable incorporado.

Junta: EPDM: -20°C hasta +100°C NBR: -20°C hasta +80°C FKM: -20°C hasta +180°C

Fluido: EPDM: Todas las calidades de agua, aguas residuales, aire, sólidos y diversos productos químicos.

NBR: Agua, gas, aceite, combustible y otros hidrocarburos.

FKM: Ozono, oxígeno, ácidos, gas, aceite y carburantes.

Especificar 1 o 2 cierres



OPEN FLEX 2 PN 16

| desde Ø exterior | hasta Ø exterior | Ref. EPDM | W1 CARCASA GALVANIZADA. CIERRES GALVANIZADOS | | | W2 CARCASA EN ACERO INOX. CIERRES GALVANIZADOS | | | W5 CARCASA EN ACERO INOX. CIERRES EN ACERO INOX. | | |
|------------------|------------------|--------------|---|----------|--------------|---|----------|--------------|---|----------|--------------|
| | | | € EPDM | € NBR | € FKM (1) | € EPDM | € NBR | € FKM (1) | € EPDM | € NBR | € FKM (1) |
| 180,0 | 199,0 | | | | | 658,97 | 658,97 | 883,05 | 743,35 | 743,35 | 967,40 |
| 200,0 | 224,0 | | | | | 682,71 | 682,71 | 935,78 | 767,07 | 767,07 | 1.020,13 |
| 225,0 | 249,0 | | | | | 872,52 | 872,52 | 1.112,38 | 962,14 | 962,14 | 1.202,01 |
| 250,0 | 274,0 | | | | | 896,25 | 896,25 | 1.180,92 | 985,87 | 985,87 | 1.270,54 |
| 275,0 | 299,0 | OF2160275W1E | 1.275,81 | 1.275,81 | 1.607,95 | 914,71 | 914,71 | 1.246,81 | 1.004,32 | 1.004,32 | 1.336,43 |
| 300,0 | 324,0 | OF2160300W1E | 1.296,89 | 1.296,89 | 1.676,52 | 943,72 | 943,72 | 1.323,28 | 1.033,35 | 1.033,35 | 1.412,91 |
| 325,0 | 349,0 | OF2160325W1E | 1.320,64 | 1.320,64 | 1.745,00 | 964,78 | 964,78 | 1.389,17 | 1.054,41 | 1.054,41 | 1.478,79 |
| 350,0 | 374,0 | OF2160350W1E | 1.341,70 | 1.341,70 | 1.808,30 | 993,78 | 993,78 | 1.460,34 | 1.083,40 | 1.083,40 | 1.549,98 |
| 375,0 | 399,0 | OF2160375W1E | 1.365,45 | 1.365,45 | 1.882,10 | 1.012,23 | 1.012,23 | 1.528,89 | 1.101,83 | 1.101,83 | 1.618,51 |
| 400,0 | 424,0 | OF2160400W1E | 1.386,50 | 1.386,50 | 1.950,66 | 1.030,67 | 1.030,67 | 1.594,75 | 1.120,30 | 1.120,30 | 1.684,39 |
| 425,0 | 449,0 | OF2160425W1E | 1.412,91 | 1.412,91 | 2.011,28 | | | | 2.640,93 | 2.640,93 | 3.886,71 |
| 450,0 | 474,0 | OF2160450W1E | 1.433,96 | 1.433,96 | 2.074,55 | | | | 2.661,84 | 2.661,84 | 3.955,42 |
| 475,0 | 499,0 | OF2160475W1E | 1.455,07 | 1.455,07 | 2.135,16 | | | | 2.676,79 | 2.676,79 | 4.021,14 |
| 500,0 | 524,0 | OF2160500W1E | 1.476,14 | 1.476,14 | 2.198,43 | | | | 2.697,67 | 2.697,67 | 4.092,84 |
| 525,0 | 549,0 | OF2160525W1E | 1.507,81 | 1.507,81 | 2.266,95 | | | | 2.715,62 | 2.715,62 | 4.161,54 |
| 550,0 | 574,0 | OF2160550W1E | 1.549,98 | 1.549,98 | 2.353,96 | | | | 2.736,50 | 2.736,50 | 4.230,25 |
| 575,0 | 599,0 | OF2160575W1E | 1.581,62 | 1.581,62 | 2.425,11 | | | | 2.754,43 | 2.754,43 | 4.298,98 |
| 600,0 | 624,0 | OF2160600W1E | 1.676,52 | 1.676,52 | 2.517,40 | | | | 2.787,30 | 2.787,30 | 4.382,63 |
| 625,0 | 649,0 | OF2160625W1E | 2.190,53 | 2.190,53 | 3.081,49 | | | | 2.805,23 | 2.805,23 | 4.451,35 |
| 650,0 | 674,0 | OF2160650W1E | 2.240,60 | 2.240,60 | 3.168,48 | | | | 2.826,14 | 2.826,14 | 4.520,02 |
| 675,0 | 699,0 | OF2160675W1E | 2.280,16 | 2.280,16 | 3.244,94 | | | | 2.844,05 | 2.844,05 | 4.591,72 |
| 700,0 | 724,0 | OF2160700W1E | 2.327,57 | 2.327,57 | 3.329,30 | | | | 2.862,00 | 2.862,00 | 4.657,47 |
| 725,0 | 749,0 | OF2160725W1E | 2.372,38 | 2.372,38 | 3.410,97 | | | | 2.891,89 | 2.891,89 | 4.738,13 |
| 750,0 | 799,0 | OF2160750W1E | 2.409,31 | 2.409,31 | 3.463,71 | | | | 2.939,65 | 2.939,65 | 4.884,51 |
| 800,0 | 849,0 | OF2160800W1E | 2.509,48 | 2.509,48 | 3.569,16 | | | | 2.984,48 | 2.984,48 | 5.030,88 |
| 850,0 | 899,0 | OF2160850W1E | 2.599,11 | 2.599,11 | 3.677,24 | | | | | | |
| 900,0 | 949,0 | OF2160900W1E | 2.686,07 | 2.686,07 | 3.835,37 | | | | | | |
| 950,0 | 999,0 | OF2160950W1E | 2.775,69 | 2.775,69 | 4.004,06 | | | | | | |
| 1.000,0 | 1.049,0 | OF2161000W1E | 2.862,70 | 2.862,70 | 4.164,87 | | | | | | |
| 1.050,0 | 1.099,0 | OF2161050W1E | 2.962,86 | 2.962,86 | 4.325,69 | | | | | | |
| 1.100,0 | 1.149,0 | OF2161100W1E | 3.044,54 | 3.044,54 | 4.460,12 | | | | | | |
| 1.150,0 | 1.199,0 | OF2161150W1E | 3.134,19 | 3.134,19 | 4.610,38 | | | | | | |
| 1.200,0 | 1.249,0 | OF2161200W1E | 3.223,81 | 3.223,81 | 4.760,62 | | | | | | |
| 1.250,0 | 1.299,0 | OF2161250W1E | 3.313,42 | 3.313,42 | 4.908,25 | | | | | | |
| 1.300,0 | 1.349,0 | OF2161300W1E | 3.403,05 | 3.403,05 | 5.058,49 | | | | | | |
| 1.350,0 | 1.399,0 | OF2161350W1E | 3.492,69 | 3.492,69 | 5.208,74 | | | | | | |
| 1.400,0 | 1.449,0 | OF2161400W1E | 3.582,30 | 3.582,30 | 5.359,00 | | | | | | |
| 1.450,0 | 1.499,0 | OF2161450W1E | 3.671,94 | 3.671,94 | 5.509,25 | | | | | | |

Acoplamiento abierto para tubos de cualquier material sin anclaje axial.

Abierto con bisagra.

Código W1 en NBR termina W1N
Código W1 en FKM termina W1F

Código W2 en EPDM termina W2E
Código W2 en NBR termina W2N
Código W2 en FKM termina W2F

Código W5 en EPDM termina W5E
Código W5 en NBR termina W5N
Código W5 en FKM termina W5F

(1) acoplamiento con anillo interior en acero inoxidable incorporado.

Junta: EPDM: -20°C hasta +100°C NBR: -20°C hasta +80°C FKM: -20°C hasta +180°C

Fluido: EPDM: Todas las calidades de agua, aguas residuales, aire, sólidos y diversos productos químicos.

NBR: Agua, gas, aceite, combustible y otros hidrocarburos.

FKM: Ozono, oxígeno, ácidos, gas, aceite y carburantes.

Especificar 1 o 2 cierres



OPEN FLEX 2 PN 20

| desde Ø exterior | hasta Ø exterior | Ref. EPDM | W1 CARCASA GALVANIZADA. CIERRES GALVANIZADOS | | | W2 CARCASA EN ACERO INOX. CIERRES GALVANIZADOS | | | W5 CARCASA EN ACERO INOX. CIERRES EN ACERO INOX. | | |
|------------------|------------------|--------------|---|----------|-----------|---|--------|-----------|---|----------|-----------|
| | | | € EPDM | € NBR | € FKM (1) | € EPDM | € NBR | € FKM (1) | € EPDM | € NBR | € FKM (1) |
| 180,0 | 199,0 | | | | | 832,96 | 832,96 | 993,78 | 922,60 | 922,60 | 1.083,40 |
| 200,0 | 224,0 | | | | | 851,43 | 851,43 | 1.049,14 | 941,05 | 941,05 | 1.138,76 |
| 225,0 | 249,0 | | | | | 872,52 | 872,51 | 1.112,38 | 962,14 | 962,14 | 1.202,01 |
| 250,0 | 274,0 | | | | | 896,25 | 896,25 | 1.180,92 | 985,87 | 985,87 | 1.270,54 |
| 275,0 | 299,0 | OF2200275W1E | 1.275,81 | 1.275,81 | 1.607,95 | 914,71 | 914,71 | 1.246,81 | 1.004,32 | 1.004,32 | 1.336,43 |
| 300,0 | 324,0 | OF2200300W1E | 1.296,89 | 1.296,89 | 1.676,52 | 943,72 | 943,72 | 1.323,28 | 1.033,35 | 1.033,35 | 1.412,91 |
| 325,0 | 349,0 | OF2200325W1E | 1.320,64 | 1.320,64 | 1.745,00 | | | | 2.560,26 | 2.560,26 | 3.602,89 |
| 350,0 | 374,0 | OF2200350W1E | 1.341,70 | 1.341,70 | 1.808,30 | | | | 2.575,18 | 2.575,18 | 3.671,61 |
| 375,0 | 399,0 | OF2200375W1E | 1.365,45 | 1.365,45 | 1.882,10 | | | | 2.602,09 | 2.602,09 | 3.749,26 |
| 400,0 | 424,0 | OF2200400W1E | 1.386,50 | 1.386,50 | 1.950,66 | | | | 2.623,02 | 2.623,02 | 3.815,02 |
| 425,0 | 449,0 | OF2200425W1E | 1.412,91 | 1.412,91 | 2.011,28 | | | | 2.640,93 | 2.640,93 | 3.886,71 |
| 450,0 | 474,0 | OF2200450W1E | 1.433,96 | 1.433,96 | 2.074,55 | | | | 2.661,84 | 2.661,84 | 3.955,42 |
| 475,0 | 499,0 | OF2200475W1E | 1.866,29 | 1.866,29 | 2.543,74 | | | | 2.676,79 | 2.676,79 | 4.021,14 |
| 500,0 | 524,0 | OF2200500W1E | 1.892,66 | 1.892,66 | 2.614,89 | | | | 2.697,67 | 2.697,67 | 4.092,84 |
| 525,0 | 549,0 | OF2200525W1E | 1.929,55 | 1.929,55 | 2.691,38 | | | | 2.715,62 | 2.715,62 | 4.161,54 |
| 550,0 | 574,0 | OF2200550W1E | 1.987,55 | 1.987,55 | 2.791,54 | | | | 2.736,50 | 2.736,50 | 4.230,25 |
| 575,0 | 599,0 | OF2200575W1E | 2.027,08 | 2.027,08 | 2.870,63 | | | | 2.754,43 | 2.754,43 | 4.298,98 |
| 600,0 | 624,0 | OF2200600W1E | 2.148,34 | 2.148,34 | 2.989,22 | | | | 2.787,30 | 2.787,30 | 4.382,63 |
| 625,0 | 649,0 | OF2200625W1E | 2.190,53 | 2.190,53 | 3.081,49 | | | | 2.805,23 | 2.805,23 | 4.451,35 |
| 650,0 | 674,0 | OF2200650W1E | 2.240,60 | 2.240,60 | 3.168,48 | | | | | | |
| 675,0 | 699,0 | OF2200675W1E | 2.280,16 | 2.280,16 | 3.244,94 | | | | | | |
| 700,0 | 724,0 | OF2200700W1E | 2.327,57 | 2.327,57 | 3.329,30 | | | | | | |
| 725,0 | 749,0 | OF2200725W1E | 2.372,38 | 2.372,38 | 3.410,97 | | | | | | |
| 750,0 | 799,0 | OF2200750W1E | 2.409,31 | 2.409,31 | 3.463,71 | | | | | | |
| 800,0 | 849,0 | OF2200800W1E | 2.509,48 | 2.509,48 | 3.569,16 | | | | | | |
| 850,0 | 899,0 | OF2200850W1E | 2.599,11 | 2.599,11 | 3.677,24 | | | | | | |
| 900,0 | 949,0 | OF2200900W1E | 2.686,07 | 2.686,07 | 3.835,37 | | | | | | |
| 950,0 | 999,0 | OF2200950W1E | 2.775,69 | 2.775,69 | 4.004,06 | | | | | | |

Acoplamiento abierto para tubos de cualquier material sin anclaje axial.

Abierto con bisagra.

Código W1 en NBR termina W1N
Código W1 en FKM termina W1F

Código W2 en EPDM termina W2E
Código W2 en NBR termina W2N
Código W2 en FKM termina W2F

Código W5 en EPDM termina W5E
Código W5 en NBR termina W5N
Código W5 en FKM termina W5F

(1) acoplamiento con anillo interior en acero inoxidable incorporado.

Junta: EPDM: -20°C hasta +100°C NBR: -20°C hasta +80°C FKM: -20°C hasta +180°C

Fluido: EPDM: Todas las calidades de agua, aguas residuales, aire, sólidos y diversos productos químicos.

NBR: Agua, gas, aceite, combustible y otros hidrocarburos.

FKM: Ozono, oxígeno, ácidos, gas, aceite y carburantes.

Especificar 1 o 2 cierres



OPEN FLEX 2 PN 25

| desde Ø exterior | hasta Ø exterior | Ref. EPDM | W1 CARCASA GALVANIZADA. CIERRES GALVANIZADOS | | | W2 CARCASA EN ACERO INOX. CIERRES GALVANIZADOS | | | W5 CARCASA EN ACERO INOX. CIERRES EN ACERO INOX. | | |
|------------------|------------------|--------------|---|----------|-----------|---|--------|-----------|---|----------|-----------|
| | | | € EPDM | € NBR | € FKM (1) | € EPDM | € NBR | € FKM (1) | € EPDM | € NBR | € FKM (1) |
| 180,0 | 199,0 | | | | | 832,96 | 832,96 | 993,78 | 922,60 | 922,60 | 1.083,40 |
| 200,0 | 224,0 | | | | | 851,43 | 851,43 | 1.049,14 | 941,05 | 941,05 | 1.138,76 |
| 225,0 | 249,0 | | | | | 872,52 | 872,51 | 1.112,38 | 962,14 | 962,14 | 1.202,01 |
| 250,0 | 274,0 | | | | | 896,25 | 896,25 | 1.180,92 | 985,87 | 985,87 | 1.270,54 |
| 275,0 | 299,0 | OF2250275W1E | 1.181,31 | 1.275,81 | 1.607,95 | | | | 2.521,41 | 2.521,41 | 3.465,47 |
| 300,0 | 324,0 | OF2250300W1E | 1.296,89 | 1.296,89 | 1.676,52 | | | | 2.539,34 | 2.539,34 | 3.531,17 |
| 325,0 | 349,0 | OF2250325W1E | 1.320,64 | 1.320,64 | 1.745,00 | | | | 2.560,26 | 2.560,26 | 3.602,89 |
| 350,0 | 374,0 | OF2250350W1E | 1.718,67 | 1.718,67 | 2.185,23 | | | | 2.575,18 | 2.575,18 | 3.671,61 |
| 375,0 | 399,0 | OF2250375W1E | 1.750,32 | 1.750,32 | 2.266,95 | | | | 2.602,09 | 2.602,09 | 3.749,26 |
| 400,0 | 424,0 | OF2250400W1E | 1.779,28 | 1.779,28 | 2.340,78 | | | | 2.623,02 | 2.623,02 | 3.815,02 |
| 425,0 | 449,0 | OF2250425W1E | 1.810,95 | 1.810,95 | 2.411,93 | | | | 2.640,93 | 2.640,93 | 3.886,71 |
| 450,0 | 474,0 | OF2250450W1E | 1.837,30 | 1.837,30 | 2.477,87 | | | | 2.661,84 | 2.661,84 | 3.955,42 |
| 475,0 | 499,0 | OF2250475W1E | 1.866,29 | 1.866,29 | 2.543,74 | | | | 2.676,79 | 2.676,79 | 4.021,14 |
| 500,0 | 524,0 | OF2250500W1E | 1.892,66 | 1.892,66 | 2.614,89 | | | | 2.697,67 | 2.697,67 | 4.092,84 |
| 525,0 | 549,0 | OF2250525W1E | 1.929,55 | 1.929,55 | 2.691,38 | | | | | | |
| 550,0 | 574,0 | OF2250550W1E | 1.987,55 | 1.987,55 | 2.791,54 | | | | | | |
| 575,0 | 599,0 | OF2250575W1E | 2.027,08 | 2.027,08 | 2.870,63 | | | | | | |
| 600,0 | 624,0 | OF2250600W1E | 2.148,34 | 2.148,34 | 2.989,22 | | | | | | |
| 625,0 | 649,0 | OF2250625W1E | 2.190,53 | 2.190,53 | 3.081,49 | | | | | | |
| 650,0 | 674,0 | OF2250650W1E | 2.240,60 | 2.240,60 | 3.168,48 | | | | | | |
| 675,0 | 699,0 | OF2250675W1E | 2.280,16 | 2.280,16 | 3.244,94 | | | | | | |
| 700,0 | 724,0 | OF2250700W1E | 2.327,57 | 2.327,57 | 3.329,30 | | | | | | |
| 725,0 | 749,0 | OF2250725W1E | 2.372,38 | 2.372,38 | 3.410,97 | | | | | | |

Acoplamiento abierto para tubos de cualquier material sin anclaje axial.

Abierto con bisagra.

Código W1 en NBR termina W1N
Código W1 en FKM termina W1F

Código W2 en EPDM termina W2E
Código W2 en NBR termina W2N
Código W2 en FKM termina W2F

Código W5 en EPDM termina W5E
Código W5 en NBR termina W5N
Código W5 en FKM termina W5F

(1) acoplamiento con anillo interior en acero inoxidable incorporado.

Junta: EPDM: -20°C hasta +100°C NBR: -20°C hasta +80°C FKM: -20°C hasta +180°C

Fluido: EPDM: Todas las calidades de agua, aguas residuales, aire, sólidos y diversos productos químicos.

NBR: Agua, gas, aceite, combustible y otros hidrocarburos.

FKM: Ozono, oxígeno, ácidos, gas, aceite y carburantes.

Especificar 1 o 2 cierres



OPEN FLEX 3 PN 2,5

| desde Ø exterior | hasta Ø exterior | Ref. EPDM | W1 CARCASA GALVANIZADA. CIERRES GALVANIZADOS | | W2 CARCASA EN ACERO INOX. CIERRES GALVANIZADOS | | W5 CARCASA EN ACERO INOX. CIERRES EN ACERO INOX. | |
|------------------|------------------|--------------|---|----------|---|----------|---|----------|
| | | | € EPDM | € NBR | € EPDM | € NBR | € EPDM | € NBR |
| 219,1 | 249,0 | | 0,00 | 0,00 | 1.676,51 | 2.129,90 | 1.876,82 | 2.330,22 |
| 250,0 | 299,0 | | 0,00 | 0,00 | 1.742,40 | 2.211,58 | 1.942,73 | 2.411,94 |
| 300,0 | 349,0 | OF3020300W1E | 2.069,27 | 2.667,63 | 1.853,09 | 2.353,96 | 2.053,44 | 2.554,29 |
| 350,0 | 399,0 | OF3020350W1E | 2.145,70 | 2.767,81 | 1.966,46 | 2.496,27 | 2.166,79 | 2.696,66 |
| 400,0 | 449,0 | OF3020400W1E | 2.222,13 | 2.865,32 | 2.077,17 | 2.638,65 | 2.277,51 | 2.838,96 |
| 450,0 | 499,0 | OF3020450W1E | 2.295,96 | 2.962,86 | 2.187,87 | 2.780,99 | 2.388,23 | 2.981,32 |
| 500,0 | 549,0 | OF3020500W1E | 2.372,38 | 3.060,42 | 2.298,62 | 2.920,71 | 2.498,93 | 3.121,04 |
| 550,0 | 599,0 | OF3020550W1E | 2.448,85 | 3.160,58 | 2.411,93 | 3.063,04 | 2.612,29 | 3.263,36 |
| 600,0 | 649,0 | OF3020600W1E | 2.525,28 | 3.258,09 | 2.522,68 | 3.202,74 | 2.722,99 | 3.403,05 |
| 650,0 | 699,0 | OF3020650W1E | 2.604,37 | 3.358,24 | 2.628,10 | 3.337,18 | 2.828,42 | 3.537,49 |
| 700,0 | 749,0 | OF3020700W1E | 2.672,92 | 3.445,25 | 2.736,19 | 3.474,26 | 2.936,50 | 3.674,59 |
| 750,0 | 799,0 | OF3020750W1E | 2.751,98 | 3.550,69 | 2.852,16 | 3.621,86 | 3.052,48 | 3.822,21 |
| 800,0 | 849,0 | OF3020800W1E | 2.831,07 | 3.650,86 | 2.960,26 | 3.758,94 | 3.160,58 | 3.959,27 |
| 850,0 | 899,0 | OF3020850W1E | 2.918,05 | 3.766,87 | 3.068,30 | 3.895,99 | 3.268,62 | 4.096,37 |
| 900,0 | 949,0 | OF3020900W1E | 3.010,32 | 3.885,47 | 3.176,37 | 4.035,74 | 3.376,72 | 4.236,05 |
| 950,0 | 999,0 | OF3020950W1E | 3.099,94 | 3.998,80 | 3.287,10 | 4.175,44 | 3.487,41 | 4.375,76 |
| 1.000,0 | 1.049,0 | OF3021000W1E | 3.192,20 | 4.120,07 | 3.387,24 | 4.304,62 | 3.587,61 | 4.504,94 |
| 1.050,0 | 1.099,0 | OF3021050W1E | 3.287,10 | 4.241,33 | 3.503,26 | 4.446,93 | 3.703,57 | 4.647,27 |
| 1.100,0 | 1.149,0 | OF3021100W1E | 3.374,10 | 4.352,03 | 3.608,70 | 4.584,01 | 3.809,02 | 4.784,35 |
| 1.150,0 | 1.199,0 | OF3021150W1E | 3.450,52 | 4.452,19 | 3.719,40 | 4.723,71 | 3.919,72 | 4.924,07 |
| 1.200,0 | 1.249,0 | OF3021200W1E | 3.555,98 | 4.589,27 | 3.864,38 | 4.905,58 | 4.064,68 | 5.105,92 |
| 1.250,0 | 1.299,0 | OF3021250W1E | 3.669,31 | 4.731,62 | 4.006,74 | 5.090,13 | 4.207,05 | 5.290,45 |
| 1.300,0 | 1.349,0 | OF3021300W1E | 3.774,75 | 4.868,71 | 4.151,70 | 5.272,02 | 4.352,03 | 5.472,32 |
| 1.350,0 | 1.399,0 | OF3021350W1E | 3.885,47 | 5.011,01 | 4.294,04 | 5.453,87 | 4.494,38 | 5.654,24 |
| 1.400,0 | 1.449,0 | OF3021400W1E | 3.990,93 | 5.148,11 | 4.439,05 | 5.635,78 | 4.639,37 | 5.836,11 |
| 1.450,0 | 1.499,0 | OF3021450W1E | 4.096,37 | 5.285,17 | 4.584,01 | 5.820,28 | 4.784,35 | 6.020,63 |
| 1.500,0 | 1.549,0 | OF3021500W1E | 4.209,70 | 5.430,16 | 4.726,36 | 6.002,16 | 4.926,67 | 6.202,52 |
| 1.550,0 | 1.599,0 | OF3021550W1E | 4.312,49 | 5.561,96 | 4.871,32 | 6.184,07 | 5.071,68 | 6.384,40 |
| 1.600,0 | 1.649,0 | OF3021600W1E | 4.407,39 | 5.685,86 | 5.013,70 | 6.368,59 | 5.214,00 | 6.568,90 |
| 1.650,0 | 1.699,0 | OF3021650W1E | 4.504,94 | 5.809,76 | 5.158,65 | 6.550,49 | 5.359,00 | 6.750,81 |
| 1.700,0 | 1.749,0 | OF3021700W1E | 4.597,18 | 5.930,98 | 5.303,63 | 6.732,35 | 5.503,96 | 6.932,68 |
| 1.750,0 | 1.799,0 | OF3021750W1E | 4.710,52 | 6.075,97 | 5.446,01 | 6.916,86 | 5.646,31 | 7.117,19 |
| 1.800,0 | 1.849,0 | OF3021800W1E | 4.829,15 | 6.231,52 | 5.590,95 | 7.098,79 | 5.791,29 | 7.299,09 |
| 1.850,0 | 1.899,0 | OF3021850W1E | 4.950,40 | 6.387,03 | 5.733,30 | 7.280,65 | 5.933,65 | 7.480,97 |
| 1.900,0 | 1.949,0 | OF3021900W1E | 5.071,68 | 6.542,56 | 5.878,29 | 7.467,80 | 6.078,64 | 7.668,13 |
| 1.950,0 | 1.999,0 | OF3021950W1E | 5.195,55 | 6.703,34 | 6.023,28 | 7.649,67 | 6.223,59 | 7.850,04 |
| 2.000,0 | 2.032,0 | OF3022000W1E | 5.322,07 | 6.864,16 | 6.165,59 | 7.831,56 | 6.365,98 | 8.031,93 |

Acoplamiento abierto para tubos de cualquier material sin anclaje axial.

Abierto con bisagra.

Código W1 en NBR termina W1N

Código W2 en EPDM termina W2E
Código W2 en NBR termina W2N

Código W5 en EPDM termina W5E
Código W5 en NBR termina W5N

(1) acoplamiento con anillo interior en acero inoxidable incorporado.

Junta: EPDM: -20°C hasta +100°C NBR: -20°C hasta +80°C

Fluido: EPDM: Todas las calidades de agua, aguas residuales, aire, sólidos y diversos productos químicos.

NBR: Agua, gas, aceite, combustible y otros hidrocarburos.

Especificar 1 o 2 cierres



OPEN FLEX 3 PN 6

| desde Ø exterior | hasta Ø exterior | Ref. EPDM | W1 CARCASA GALVANIZADA. CIERRES GALVANIZADOS | | W2 CARCASA EN ACERO INOX. CIERRES GALVANIZADOS | | W5 CARCASA EN ACERO INOX. CIERRES EN ACERO INOX. | |
|------------------|------------------|--------------|---|----------|---|----------|---|----------|
| | | | € EPDM | € NBR | € EPDM | € NBR | € EPDM | € NBR |
| 219,1 | 249,0 | | | | 1.676,51 | 2.129,90 | 1.876,82 | 2.330,22 |
| 250,0 | 299,0 | | | | 1.742,40 | 2.211,58 | 1.942,73 | 2.411,94 |
| 300,0 | 349,0 | OF3060300W1E | 2.069,27 | 2.667,63 | 1.853,09 | 2.353,96 | 2.053,44 | 2.554,29 |
| 350,0 | 399,0 | OF3060350W1E | 2.145,70 | 2.767,81 | 1.966,46 | 2.496,27 | 2.166,79 | 2.696,66 |
| 400,0 | 449,0 | OF3060400W1E | 2.222,13 | 2.865,32 | 2.077,17 | 2.638,65 | 2.277,51 | 2.838,96 |
| 450,0 | 499,0 | OF3060450W1E | 2.295,96 | 2.962,86 | 2.187,87 | 2.780,99 | 2.388,23 | 2.981,32 |
| 500,0 | 549,0 | OF3060500W1E | 2.372,38 | 3.060,42 | 2.298,62 | 2.920,71 | 2.498,93 | 3.121,04 |
| 550,0 | 599,0 | OF3060550W1E | 2.448,85 | 3.160,58 | 2.411,93 | 3.063,04 | 2.612,29 | 3.263,36 |
| 600,0 | 649,0 | OF3060600W1E | 2.525,28 | 3.258,09 | 2.522,68 | 3.202,74 | 2.722,99 | 3.403,05 |
| 650,0 | 699,0 | OF3060650W1E | 2.604,37 | 3.358,24 | 2.628,10 | 3.337,18 | 2.828,42 | 3.537,49 |
| 700,0 | 749,0 | OF3060700W1E | 2.672,92 | 3.445,25 | 2.736,19 | 3.474,26 | 2.936,50 | 3.674,59 |
| 750,0 | 799,0 | OF3060750W1E | 2.751,98 | 3.550,69 | 2.852,16 | 3.621,86 | 3.052,48 | 3.822,21 |
| 800,0 | 849,0 | OF3060800W1E | 2.831,07 | 3.650,86 | 2.960,26 | 3.758,94 | 3.160,58 | 3.959,27 |
| 850,0 | 899,0 | OF3060850W1E | 2.918,05 | 3.766,87 | 3.068,30 | 3.895,99 | 3.268,62 | 4.096,37 |
| 900,0 | 949,0 | OF3060900W1E | 3.010,32 | 3.885,47 | 3.176,37 | 4.035,74 | 3.376,72 | 4.236,05 |
| 950,0 | 999,0 | OF3060950W1E | 3.099,94 | 3.998,80 | 3.287,10 | 4.175,44 | 3.487,41 | 4.375,76 |
| 1.000,0 | 1.049,0 | OF3061000W1E | 3.192,20 | 4.120,07 | | | 4.642,54 | 4.884,51 |
| 1.050,0 | 1.099,0 | OF3061050W1E | 3.287,10 | 4.241,33 | | | 4.717,20 | 4.968,15 |
| 1.100,0 | 1.149,0 | OF3061100W1E | 3.374,10 | 4.352,03 | | | 4.788,91 | 5.051,81 |
| 1.150,0 | 1.199,0 | OF3061150W1E | 3.450,52 | 4.452,19 | | | 4.881,52 | 5.153,38 |
| 1.200,0 | 1.249,0 | OF3061200W1E | 3.555,98 | 4.589,27 | | | 4.968,15 | 5.254,93 |
| 1.250,0 | 1.299,0 | OF3061250W1E | 3.669,31 | 4.731,62 | | | 5.036,87 | 5.332,63 |
| 1.300,0 | 1.349,0 | OF3061300W1E | 3.774,75 | 4.868,71 | | | 5.126,50 | 5.434,21 |
| 1.350,0 | 1.399,0 | OF3061350W1E | 3.885,47 | 5.011,01 | | | 5.216,13 | 5.535,77 |
| 1.400,0 | 1.449,0 | OF3061400W1E | 3.990,93 | 5.148,11 | | | 5.299,76 | 5.628,39 |
| 1.450,0 | 1.499,0 | OF3061450W1E | 4.096,37 | 5.285,17 | | | 5.416,29 | 5.753,86 |
| 1.500,0 | 1.549,0 | OF3061500W1E | 4.209,70 | 5.430,16 | | | 5.526,84 | 5.876,37 |
| 1.550,0 | 1.599,0 | OF3061550W1E | 4.312,49 | 5.561,96 | | | 5.613,46 | 5.971,94 |
| 1.600,0 | 1.649,0 | OF3061600W1E | 4.407,39 | 5.685,86 | | | 5.706,06 | 6.076,51 |
| 1.650,0 | 1.699,0 | OF3061650W1E | 4.504,94 | 5.809,76 | | | 5.816,61 | 6.199,02 |
| 1.700,0 | 1.749,0 | OF3061700W1E | 4.597,18 | 5.930,98 | | | 5.927,14 | 6.321,48 |
| 1.750,0 | 1.799,0 | OF3061750W1E | 4.710,52 | 6.075,97 | | | 6.037,67 | 6.443,97 |
| 1.800,0 | 1.849,0 | OF3061800W1E | 4.829,15 | 6.231,52 | | | 6.479,82 | 6.898,06 |
| 1.850,0 | 1.899,0 | OF3061850W1E | 4.950,40 | 6.387,03 | | | 6.560,47 | 6.987,70 |
| 1.900,0 | 1.949,0 | OF3061900W1E | 5.071,68 | 6.542,56 | | | 6.638,17 | 7.077,32 |
| 1.950,0 | 1.999,0 | OF3061950W1E | 5.195,55 | 6.703,34 | | | 6.739,73 | 7.187,86 |
| 2.000,0 | 2.032,0 | OF3062000W1E | 5.322,07 | 6.864,16 | | | 6.850,26 | 7.310,34 |

Acoplamiento abierto para tubos de cualquier material sin anclaje axial.

Abierto con bisagra.

Código W1 en NBR termina W1N

Código W2 en EPDM termina W2E
Código W2 en NBR termina W2N

Código W5 en EPDM termina W5E
Código W5 en NBR termina W5N

En caso de pedido indicar el diámetro exterior exacto

Junta: EPDM: -20°C hasta +100°C NBR: -20°C hasta +80°C

Fluido: EPDM: Todas las calidades de agua, aguas residuales, aire, sólidos y diversos productos químicos.
NBR: Agua, gas, aceite, combustible y otros hidrocarburos.

Especificar 1 o 2 cierres



OPEN FLEX 3 PN 10

| desde Ø exterior | hasta Ø exterior | Ref. EPDM | W1 CARCASA GALVANIZADA. CIERRES GALVANIZADOS | | W2 CARCASA EN ACERO INOX. CIERRES GALVANIZADOS | | W5 CARCASA EN ACERO INOX. CIERRES EN ACERO INOX. | |
|------------------|------------------|--------------|---|-----------|---|----------|---|-----------|
| | | | € EPDM | € NBR | € EPDM | € NBR | € EPDM | € NBR |
| 219,1 | 249,0 | | | | 1.676,51 | 2.129,90 | 1.876,82 | 2.330,22 |
| 250,0 | 299,0 | | | | 1.742,40 | 2.211,58 | 1.942,73 | 2.411,94 |
| 300,0 | 349,0 | OF3100300W1E | 2.069,27 | 2.667,63 | 1.853,09 | 2.353,96 | 2.053,44 | 2.554,29 |
| 350,0 | 399,0 | OF3100350W1E | 2.145,70 | 2.767,81 | 1.966,46 | 2.496,27 | 2.166,79 | 2.696,66 |
| 400,0 | 449,0 | OF3100400W1E | 2.222,13 | 2.865,32 | 2.077,17 | 2.638,65 | 2.277,51 | 2.838,96 |
| 450,0 | 499,0 | OF3100450W1E | 2.295,96 | 2.962,86 | 2.187,87 | 2.780,99 | 2.388,23 | 2.981,32 |
| 500,0 | 549,0 | OF3100500W1E | 2.372,38 | 3.060,42 | | | 3.653,69 | 3.779,15 |
| 525,0 | 549,0 | | | | | | 3.710,42 | 3.841,90 |
| 550,0 | 599,0 | OF3100550W1E | 2.448,85 | 3.160,58 | | | 3.773,18 | 3.907,61 |
| 575,0 | 599,0 | | | | | | 3.829,93 | 3.973,31 |
| 600,0 | 649,0 | OF3100600W1E | 2.525,28 | 3.258,09 | | | 3.916,59 | 4.071,91 |
| 650,0 | 699,0 | OF3100650W1E | 2.604,37 | 3.358,24 | | | 3.991,24 | 4.155,59 |
| 700,0 | 749,0 | OF3100700W1E | 2.672,92 | 3.445,25 | | | 4.062,93 | 4.236,23 |
| 750,0 | 799,0 | OF3100750W1E | 2.751,98 | 3.550,69 | | | 4.137,67 | 4.325,86 |
| 800,0 | 849,0 | OF3100800W1E | 2.831,07 | 3.650,86 | | | 4.215,30 | 4.412,48 |
| 850,0 | 899,0 | OF3100850W1E | 2.918,05 | 3.766,87 | | | 4.337,80 | 4.543,94 |
| 900,0 | 949,0 | OF3100900W1E | 3.010,32 | 3.885,47 | | | 4.457,30 | 4.681,35 |
| 950,0 | 999,0 | OF3100950W1E | 3.099,94 | 3.998,80 | | | 4.555,87 | 4.785,93 |
| 1.000,0 | 1.049,0 | OF3101000W1E | 3.192,20 | 4.120,07 | | | 4.642,54 | 4.884,51 |
| 1.050,0 | 1.099,0 | OF3101050W1E | 3.287,10 | 4.241,33 | | | 4.717,20 | 4.968,15 |
| 1.100,0 | 1.149,0 | OF3101100W1E | 3.374,10 | 4.352,03 | | | 4.788,91 | 5.051,81 |
| 1.150,0 | 1.199,0 | OF3101150W1E | 3.450,52 | 4.452,19 | | | 4.881,52 | 5.153,38 |
| 1.200,0 | 1.249,0 | OF3101200W1E | 3.555,98 | 4.589,27 | | | 4.968,15 | 5.254,93 |
| 1.250,0 | 1.299,0 | OF3101250W1E | 7.779,38 | 8.490,38 | | | 5.036,87 | 5.332,63 |
| 1.300,0 | 1.349,0 | OF3101300W1E | 7.892,90 | 8.615,84 | | | 5.126,50 | 5.434,21 |
| 1.350,0 | 1.399,0 | OF3101350W1E | 7.997,45 | 8.732,36 | | | 5.216,13 | 5.535,77 |
| 1.400,0 | 1.449,0 | OF3101400W1E | 8.110,98 | 8.860,84 | | | 5.299,76 | 5.628,39 |
| 1.450,0 | 1.499,0 | OF3101450W1E | 8.224,51 | 8.989,31 | | | Consultar | Consultar |
| 1.500,0 | 1.549,0 | OF3101500W1E | 8.332,06 | 9.108,78 | | | | |
| 1.550,0 | 1.599,0 | OF3101550W1E | 8.442,59 | 9.234,26 | | | | |
| 1.600,0 | 1.649,0 | OF3101600W1E | 8.550,15 | 9.353,77 | | | | |
| 1.650,0 | 1.699,0 | OF3101650W1E | 8.663,68 | 9.479,24 | | | | |
| 1.700,0 | 1.749,0 | OF3101700W1E | 8.771,20 | 9.601,69 | | | | |
| 1.750,0 | 1.799,0 | OF3101750W1E | 8.884,72 | 9.727,18 | | | | |
| 1.800,0 | 1.849,0 | OF3101800W1E | 8.989,31 | 9.846,71 | | | | |
| 1.850,0 | 1.899,0 | OF3101850W1E | 9.102,83 | 9.972,20 | | | | |
| 1.900,0 | 1.949,0 | OF3101900W1E | 9.210,37 | 10.091,69 | | | | |
| 1.950,0 | 1.999,0 | OF3101950W1E | 9.323,86 | 10.220,12 | | | | |
| 2.000,0 | 2.032,0 | OF3102000W1E | 9.428,45 | 10.336,64 | | | | |

Acoplamiento abierto para tubos de cualquier material sin anclaje axial.

Abierto con bisagra.

Código W1 en NBR termina W1N

Código W2 en EPDM termina W2E
Código W2 en NBR termina W2N

Código W5 en EPDM termina W5E
Código W5 en NBR termina W5N

En caso de pedido indicar el diámetro exterior exacto

Junta: EPDM: -20°C hasta +100°C NBR: -20°C hasta +80°C

Fluido: EPDM: Todas las calidades de agua, aguas residuales, aire, sólidos y diversos productos químicos.

NBR: Agua, gas, aceite, combustible y otros hidrocarburos.

Especificar 1 o 2 cierres



OPEN FLEX 3 PN 16

| desde Ø exterior | hasta Ø exterior | Ref. EPDM | W1 CARCASA GALVANIZADA. CIERRES GALVANIZADOS | | W2 CARCASA EN ACERO INOX. CIERRES GALVANIZADOS | | W5 CARCASA EN ACERO INOX. CIERRES EN ACERO INOX. | |
|------------------|------------------|--------------|---|-----------|---|----------|---|-----------|
| | | | € EPDM | € NBR | € EPDM | € NBR | € EPDM | € NBR |
| 219,0 | 249,0 | | | | 1.676,51 | 2.129,90 | 1.876,82 | 2.330,22 |
| 250,0 | 299,0 | | | | 1.742,40 | 2.211,58 | 1.942,73 | 2.411,94 |
| 300,0 | 349,0 | OF3160300W1E | 2.069,27 | 2.667,63 | 1.853,09 | 2.353,96 | 2.053,44 | 2.554,29 |
| 350,0 | 399,0 | OF3160350W1E | 2.145,70 | 2.767,81 | | | 3.292,17 | 3.384,81 |
| 375,0 | 399,0 | | | | | | 3.357,93 | 3.456,52 |
| 400,0 | 449,0 | OF3160400W1E | 2.222,13 | 2.865,32 | | | 3.414,68 | 3.519,25 |
| 425,0 | 449,0 | | | | | | 3.474,42 | 3.584,97 |
| 450,0 | 499,0 | OF3160450W1E | 2.295,96 | 2.962,86 | | | 3.534,16 | 3.650,68 |
| 475,0 | 499,0 | | | | | | 3.593,92 | 3.713,41 |
| 500,0 | 549,0 | OF3160500W1E | 2.372,38 | 3.060,42 | | | 3.653,69 | 3.779,15 |
| 525,0 | 549,0 | | | | | | 3.710,42 | 3.841,90 |
| 550,0 | 599,0 | OF3160550W1E | 2.448,85 | 3.160,58 | | | 3.773,18 | 3.907,61 |
| 575,0 | 599,0 | | | | | | 3.829,93 | 3.973,31 |
| 600,0 | 649,0 | OF3160600W1E | 2.525,28 | 3.258,09 | | | 3.916,59 | 4.071,91 |
| 650,0 | 699,0 | OF3160650W1E | 2.604,37 | 3.358,24 | | | 3.991,24 | 4.155,59 |
| 700,0 | 749,0 | OF3160700W1E | 2.672,92 | 3.445,25 | | | 4.062,93 | 4.236,23 |
| 750,0 | 799,0 | OF3160750W1E | 6.303,54 | 6.880,16 | | | 4.137,67 | 4.325,86 |
| 800,0 | 849,0 | OF3160800W1E | 6.420,07 | 7.005,64 | | | 4.215,30 | 4.412,48 |
| 850,0 | 899,0 | OF3160850W1E | 6.527,60 | 7.125,10 | | | Consultar | Consultar |
| 900,0 | 949,0 | OF3160900W1E | 6.638,17 | 7.253,57 | | | | |
| 950,0 | 999,0 | OF3160950W1E | 6.745,73 | 7.373,09 | | | | |
| 1.000,0 | 1.049,0 | OF3161000W1E | 6.859,22 | 7.498,58 | | | | |
| 1.050,0 | 1.099,0 | OF3161050W1E | 6.972,76 | 7.627,00 | | | | |
| 1.100,0 | 1.149,0 | OF3161100W1E | 7.447,76 | 8.113,96 | | | | |
| 1.150,0 | 1.199,0 | OF3161150W1E | 7.561,28 | 8.239,43 | | | | |
| 1.200,0 | 1.249,0 | OF3161200W1E | 7.665,84 | 8.361,92 | | | | |
| 1.250,0 | 1.299,0 | OF3161250W1E | 7.779,38 | 8.490,38 | | | | |
| 1.300,0 | 1.349,0 | OF3161300W1E | 7.892,90 | 8.615,84 | | | | |
| 1.350,0 | 1.399,0 | OF3161350W1E | 7.997,45 | 8.732,36 | | | | |
| 1.400,0 | 1.449,0 | OF3161400W1E | 8.110,98 | 8.860,84 | | | | |
| 1.450,0 | 1.499,0 | OF3161450W1E | 8.224,51 | 8.989,31 | | | | |
| 1.500,0 | 1.549,0 | OF3161500W1E | 8.332,06 | 9.108,78 | | | | |
| 1.550,0 | 1.599,0 | OF3161550W1E | Consultar | Consultar | | | | |

Acoplamiento abierto para tubos de cualquier material sin anclaje axial.

Abierto con bisagra.

Código W1 en NBR termina W1N

Código W2 en EPDM termina W2E

Código W5 en EPDM termina W5E

Código W2 en NBR termina W2N

Código W5 en NBR termina W5N

En caso de pedido indicar el diámetro exterior exacto

Junta: EPDM: -20°C hasta +100°C NBR: -20°C hasta +80°C

Fluido: EPDM: Todas las calidades de agua, aguas residuales, aire, sólidos y diversos productos químicos.

NBR: Agua, gas, aceite, combustible y otros hidrocarburos.

Especificar 1 o 2 cierres



OPEN FLEX 3 PN 20

W1 CARCASA GALVANIZADA. CIERRES GALVANIZADOS

W5 CARCASA EN ACERO INOX. CIERRES EN ACERO INOX.

| desde Ø exterior | hasta Ø exterior | Ref. EPDM | € EPDM | Ref. NBR | € NBR | Ref. EPDM | € EPDM | Ref. NBR | € NBR |
|------------------|------------------|--------------|-----------|--------------|-----------|--------------|-----------|--------------|-----------|
| 323,9 | 349,0 | OF3200323W1E | 2.069,27 | OF3200323W1N | 2.667,63 | OF3200323W5E | 3.232,44 | OF3200323W5N | 3.319,06 |
| 350,0 | 399,0 | OF3200350W1E | 2.145,70 | OF3200350W1N | 2.767,81 | OF3200350W5E | 3.292,17 | OF3200350W5N | 3.384,81 |
| 375,0 | 399,0 | | | | | OF3200375W5E | 3.357,93 | OF3200375W5N | 3.456,52 |
| 400,0 | 449,0 | OF3200400W1E | 2.222,13 | OF3200400W1N | 2.865,32 | OF3200400W5E | 3.414,68 | OF3200400W5N | 3.519,25 |
| 425,0 | 449,0 | | | | | OF3200425W5E | 3.474,42 | OF3200425W5N | 3.584,97 |
| 450,0 | 499,0 | OF3200450W1E | 2.295,96 | OF3200450W1N | 2.962,86 | OF3200450W5E | 3.534,16 | OF3200450W5N | 3.650,68 |
| 475,0 | 499,0 | | | | | OF3200475W5E | 3.593,92 | OF3200475W5N | 3.713,41 |
| 500,0 | 549,0 | OF3200500W1E | 2.372,38 | OF3200500W1N | 3.060,42 | OF3200500W5E | 3.653,69 | OF3200500W5N | 3.779,15 |
| 525,0 | 549,0 | | | | | OF3200525W5E | 3.710,42 | OF3200525W5N | 3.841,90 |
| 550,0 | 599,0 | OF3200550W1E | 5.924,15 | OF3200550W1N | 6.449,94 | OF3200550W5E | 3.773,18 | OF3200550W5N | 3.907,61 |
| 575,0 | 599,0 | | | | | OF3200575W5E | 3.829,93 | OF3200575W5N | 3.973,31 |
| 600,0 | 649,0 | OF3200600W1E | 5.980,90 | OF3200600W1N | 6.518,64 | OF3200600W5E | 3.916,59 | OF3200600W5N | 4.071,91 |
| 650,0 | 699,0 | OF3200650W1E | 6.085,48 | OF3200650W1N | 6.638,17 | OF3200650W5E | Consultar | OF3200650W5N | Consultar |
| 700,0 | 749,0 | OF3200700W1E | 6.199,02 | OF3200700W1N | 6.763,64 | | | | |
| 750,0 | 799,0 | OF3200750W1E | 6.303,54 | OF3200750W1N | 6.880,16 | | | | |
| 800,0 | 849,0 | OF3200800W1E | 6.420,07 | OF3200800W1N | 7.005,64 | | | | |
| 850,0 | 899,0 | OF3200850W1E | 6.527,60 | OF3200850W1N | 7.125,10 | | | | |
| 900,0 | 949,0 | OF3200900W1E | 6.638,17 | OF3200900W1N | 7.253,57 | | | | |
| 950,0 | 999,0 | OF3200950W1E | 6.745,73 | OF3200950W1N | 7.373,09 | | | | |
| 1.000,0 | 1.049,0 | OF3201000W1E | 6.859,22 | OF3201000W1N | 7.498,58 | | | | |
| 1.050,0 | 1.099,0 | OF3201050W1E | 6.972,76 | OF3201050W1N | 7.627,00 | | | | |
| 1.100,0 | 1.149,0 | OF3201100W1E | 7.447,76 | OF3201100W1N | 8.113,96 | | | | |
| 1.150,0 | 1.199,0 | OF3201150W1E | Consultar | OF3201150W1N | Consultar | | | | |

Acoplamiento abierto para tubos de cualquier material sin anclaje axial. Abierto con bisagra.

En caso de pedido indicar el diámetro exterior exacto.
 Junta: EPDM: -20°C hasta +100°C NBR: -20°C hasta +80°C
 Fluido: EPDM: Todas las calidades de agua, aguas residuales, aire, sólidos y diversos productos químicos.
 NBR: Agua, gas, aceite, combustible y otros hidrocarburos.
 Especificar 1 o 2 cierres



OPEN FLEX 3 PN 25

W1 CARCASA GALVANIZADA. CIERRES GALVANIZADOS

W5 CARCASA EN ACERO INOX. CIERRES EN ACERO INOX.

| desde Ø exterior | hasta Ø exterior | Ref. EPDM | € EPDM | Ref. NBR | € NBR | Ref. EPDM | € EPDM | Ref. NBR | € NBR |
|------------------|------------------|--------------|-----------|--------------|-----------|--------------|-----------|--------------|-----------|
| 323,9 | 349,0 | OF3250323W1E | 2.069,27 | OF3250323W1N | 2.667,63 | OF3250323W5E | 3.232,44 | OF3250323W5N | 3.319,06 |
| 350,0 | 399,0 | OF3250350W1E | 2.145,70 | OF3250350W1N | 2.767,81 | OF3250350W5E | 3.292,17 | OF3250350W5N | 3.384,81 |
| 375,0 | 399,0 | | | | | OF3250375W5E | 3.357,93 | OF3250375W5N | 3.456,52 |
| 400,0 | 449,0 | OF3250400W1E | 2.222,13 | OF3250400W1N | 2.865,32 | OF3250400W5E | 3.414,68 | OF3250400W5N | 3.519,25 |
| 425,0 | 449,0 | | | | | OF3250425W5E | 3.474,42 | OF3250425W5N | 3.584,97 |
| 450,0 | 499,0 | OF3250450W1E | 2.295,96 | OF3250450W1N | 2.962,86 | OF3250450W5E | 3.534,16 | OF3250450W5N | 3.650,68 |
| 475,0 | 499,0 | | | | | OF3250475W5E | 3.593,92 | OF3250475W5N | 3.713,41 |
| 500,0 | 549,0 | OF3250550W1E | Consultar | OF3250550W1N | Consultar | OF3250500W5E | Consultar | OF3250500W5N | Consultar |
| 550,0 | 599,0 | OF3250600W1E | 5.924,15 | OF3250600W1N | 6.449,94 | | | | |
| 600,0 | 649,0 | OF3250650W1E | 5.980,90 | OF3250650W1N | 6.518,64 | | | | |
| 650,0 | 699,0 | OF3250700W1E | 6.085,48 | OF3250700W1N | 6.638,17 | | | | |
| 700,0 | 749,0 | OF3250750W1E | 6.199,02 | OF3250750W1N | 6.763,64 | | | | |
| 750,0 | 799,0 | OF3250800W1E | 6.303,54 | OF3250800W1N | 6.880,16 | | | | |
| 800,0 | 849,0 | OF3250850W1E | 6.420,07 | OF3250850W1N | 7.005,64 | | | | |
| 850,0 | 899,0 | OF3250900W1E | 6.527,60 | OF3250900W1N | 7.125,10 | | | | |
| 900,0 | 949,0 | OF3250950W1E | 6.638,17 | OF3250950W1N | 7.253,57 | | | | |
| 950,0 | 999,0 | OF3201150W1E | Consultar | OF3201150W1N | Consultar | | | | |

Acoplamiento abierto para tubos de cualquier material sin anclaje axial. Abierto con bisagra.

En caso de pedido indicar el diámetro exterior exacto.
Junta: EPDM: -20°C hasta +100°C NBR: -20°C hasta +80°C
Fluido: EPDM: Todas las calidades de agua, aguas residuales, aire, sólidos y diversos productos químicos.
 NBR: Agua, gas, aceite, combustible y otros hidrocarburos.
 Especificar 1 o 2 cierres



STEP FLEX 2

CARCASA GALVANIZADA / ACERO INOXIDABLE

| Ø exterior tubo 1 | Ø exterior tubo 2 | Ref. EPDM | € EPDM |
|-------------------|-------------------|-----------|-----------|
| 219,1 | 230 - 250 | STF2219E | CONSULTAR |
| 250,0 | 220 - 280 | STF2250E | CONSULTAR |
| 267,0 | 237 - 297 | STF2267E | CONSULTAR |
| 273,0 | 243 - 303 | STF2273E | CONSULTAR |
| 304,0 | 274 - 334 | STF2304E | CONSULTAR |
| 323,9 | 293 - 353 | STF2323E | CONSULTAR |
| 355,6 | 325 - 385 | STF2355E | CONSULTAR |
| 406,4 | 376 - 436 | STF2406E | CONSULTAR |
| 457,2 | 427 - 487 | STF2457E | CONSULTAR |
| 508,0 | 478 - 538 | STF2508E | CONSULTAR |
| 558,8 | 528 - 588 | STF2558E | CONSULTAR |
| 609,6 | 579 - 639 | STF2609E | CONSULTAR |
| 711,2 | 681 - 741 | STF2711E | CONSULTAR |
| 762,0 | 732 - 792 | STF2762E | CONSULTAR |
| 812,8 | 782 - 842 | STF2812E | CONSULTAR |

Acoplamiento para tubos de cualquier material sin anclaje axial.

Unión para tuberías de diferentes materiales y diámetros.

Junta: EPDM: -20°C hasta +100°C

Fluido: EPDM: Todas las calidades de agua, aguas residuales, aire, sólidos y diversos productos químicos.



STEP FLEX 3

CARCASA GALVANIZADA / ACERO INOXIDABLE

| Ø exterior tubo 1 | Ø exterior tubo 2 | Ref. EPDM | € EPDM |
|-------------------|-------------------|-----------|-----------|
| 914,4 | 884 - 944 | STF30914E | CONSULTAR |
| 1.016,0 | 986 - 1046 | STF31016E | CONSULTAR |
| 1.117,6 | 1087 - 1147 | STF31117E | CONSULTAR |
| 1.219,2 | 1.189 - 1.249 | STF31219E | CONSULTAR |
| 1.320,8 | 1.290 - 1.350 | STF31320E | CONSULTAR |
| 1.422,4 | 1.392 - 1.452 | STF31422E | CONSULTAR |
| 1.524,0 | 1.494 - 1.554 | STF31524E | CONSULTAR |
| 1.600,0 | 1.570 - 1.630 | STF31600E | CONSULTAR |
| 1.625,4 | 1.595 - 1.655 | STF31625E | CONSULTAR |
| 1.727,2 | 1.697 - 1.757 | STF31727E | CONSULTAR |
| 1.828,8 | 1.798 - 1.858 | STF31828E | CONSULTAR |
| 1.930,4 | 1.900 - 1.960 | STF31930E | CONSULTAR |
| 2.032,0 | 2.002 - 2.062 | STF32032E | CONSULTAR |

Acoplamiento para tubos de cualquier material sin anclaje axial.

Unión para tuberías de diferentes materiales y diámetros.

Junta: EPDM: -20°C hasta +100°C

Fluido: EPDM: Todas las calidades de agua, aguas residuales, aire, sólidos y diversos productos químicos.



STRAUB CLAMP

ABRAZADERAS SIMPLES DE REPARACIÓN / SCE / LONGITUD 200

| Tolerancia (mm) | Código EPDM | €/Un. EPDM | Código NBR | €/Un. NBR |
|-----------------|-------------|------------|-------------|-----------|
| 44-48 | 391-044-200 | 135,77 | 381-044-200 | 123,33 |
| 48-52 | 391-048-200 | 137,36 | 381-048-200 | 124,83 |
| 54-58 | 391-054-200 | 137,36 | 381-054-200 | 124,83 |
| 60-67 | 391-060-200 | 138,90 | 381-060-200 | 126,41 |
| 67-74 | 391-067-200 | 143,57 | 381-067-200 | 131,14 |
| 70-77 | 391-070-200 | 148,30 | 381-070-200 | 135,77 |
| 75-81 | 391-075-200 | 159,19 | 381-075-200 | 140,49 |
| 82-89 | 391-082-200 | 162,27 | 381-082-200 | 143,57 |
| 87-95 | 391-087-200 | 165,45 | 381-087-200 | 148,30 |
| 88-95 | 391-088-200 | 168,58 | 381-088-200 | 152,92 |
| 95-104 | 391-095-200 | 173,25 | 381-095-200 | 159,19 |
| 108-118 | 391-108-200 | 182,64 | 381-108-200 | 166,98 |
| 113-123 | 391-113-200 | 187,27 | 381-113-200 | 171,71 |
| 118-128 | 391-118-200 | 191,99 | 381-118-200 | 174,79 |
| 120-131 | 391-120-200 | 195,08 | 381-120-200 | 179,42 |
| 132-142 | 391-132-200 | 206,06 | 381-132-200 | 187,27 |
| 135-145 | 391-135-200 | 213,82 | 381-135-200 | 191,99 |
| 139-149 | 391-139-200 | 213,82 | 381-139-200 | 191,99 |
| 145-155 | 391-145-200 | 220,08 | 381-145-200 | 195,08 |
| 159-170 | 391-159-200 | 226,29 | 381-159-200 | 204,42 |
| 167-178 | 391-167-200 | 230,97 | 381-167-200 | 210,63 |
| 176-187 | 391-176-200 | 240,36 | 381-176-200 | 220,08 |
| 193-203 | 391-193-200 | 249,71 | 381-193-200 | 229,42 |
| 215-225 | 391-215-200 | 263,78 | 381-215-200 | 240,36 |
| 228-239 | 391-228-200 | 271,53 | 381-228-200 | 246,58 |
| 240-250 | 391-240-200 | 282,47 | 381-240-200 | 252,84 |
| 261-271 | 391-261-200 | 291,81 | 381-261-200 | 265,32 |
| 269-280 | 391-269-200 | 296,49 | 381-269-200 | 269,99 |

Material: Acero inoxidable AISI 304.

Juntas: EPDM o NBR.



STRAUB CLAMP

ABRAZADERAS SIMPLES DE REPARACIÓN / SCE / LONGITUD 300

| Tolerancia (mm) | Código EPDM | €/Un. EPDM | Código NBR | €/Un. NBR |
|-----------------|-------------|------------|-------------|-----------|
| 44-48 | 391-044-300 | 152,92 | 381-044-300 | 137,36 |
| 48-52 | 391-048-300 | 160,77 | 381-048-300 | 141,98 |
| 54-58 | 391-054-300 | 163,90 | 381-054-300 | 146,75 |
| 60-67 | 391-060-300 | 206,06 | 381-060-300 | 187,27 |
| 67-74 | 391-067-300 | 220,08 | 381-067-300 | 195,08 |
| 70-77 | 391-070-300 | 223,21 | 381-070-300 | 199,74 |
| 75-81 | 391-075-300 | 227,84 | 381-075-300 | 206,06 |
| 82-89 | 391-082-300 | 237,18 | 381-082-300 | 218,48 |
| 87-95 | 391-087-300 | 240,36 | 381-087-300 | 220,08 |
| 88-95 | 391-088-300 | 243,50 | 381-088-300 | 223,21 |
| 95-104 | 391-095-300 | 249,71 | 381-095-300 | 229,42 |
| 108-118 | 391-108-300 | 263,78 | 381-108-300 | 240,36 |
| 113-123 | 391-113-300 | 271,53 | 381-113-300 | 246,58 |
| 118-128 | 391-118-300 | 285,60 | 381-118-300 | 255,97 |
| 120-131 | 391-120-300 | 288,73 | 381-120-300 | 262,18 |
| 132-142 | 391-132-300 | 301,21 | 381-132-300 | 273,12 |
| 135-145 | 391-135-300 | 313,64 | 381-135-300 | 287,15 |
| 139-149 | 391-139-300 | 313,64 | 381-139-300 | 287,15 |
| 145-155 | 391-145-300 | 319,91 | 381-145-300 | 291,81 |
| 159-170 | 391-159-300 | 335,56 | 381-159-300 | 304,29 |
| 167-178 | 391-167-300 | 343,32 | 381-167-300 | 309,02 |
| 176-187 | 391-176-300 | 355,89 | 381-176-300 | 323,09 |
| 193-203 | 391-193-300 | 366,78 | 381-193-300 | 333,97 |
| 215-225 | 391-215-300 | 396,41 | 381-215-300 | 358,98 |
| 228-239 | 391-228-300 | 418,24 | 381-228-300 | 379,25 |
| 240-250 | 391-240-300 | 449,45 | 381-240-300 | 408,88 |
| 261-271 | 391-261-300 | 465,11 | 381-261-300 | 421,32 |
| 269-280 | 391-269-300 | 500,95 | 381-269-300 | 455,66 |
| 280-291 | 391-280-300 | 505,63 | 381-280-300 | 461,98 |
| 315-325 | 391-315-300 | 594,62 | 381-315-300 | 540,03 |
| 320-330 | 391-320-300 | 613,30 | 381-320-300 | 557,18 |

Material: Acero inoxidable AISI 304.

Juntas: EPDM o NBR.



STRAUB CLAMP

ABRAZADERAS SIMPLES DE REPARACIÓN / SCE / LONGITUD 400

| Tolerancia (mm) | Código EPDM | €/Un. EPDM | Código NBR | €/Un. NBR |
|-----------------|-------------|------------|-------------|-----------|
| 82-89 | 391-082-400 | 307,47 | 381-082-400 | 282,47 |
| 87-95 | 391-087-400 | 313,64 | 381-087-400 | 287,15 |
| 88-95 | 391-088-400 | 315,28 | 381-088-400 | 288,73 |
| 95-104 | 391-095-400 | 330,89 | 381-095-400 | 301,21 |
| 108-118 | 391-108-400 | 351,12 | 381-108-400 | 316,81 |
| 113-123 | 391-113-400 | 355,89 | 381-113-400 | 323,09 |
| 118-128 | 391-118-400 | 363,60 | 381-118-400 | 330,89 |
| 120-131 | 391-120-400 | 366,78 | 381-120-400 | 333,97 |
| 132-142 | 391-132-400 | 387,06 | 381-132-400 | 352,72 |
| 135-145 | 391-135-400 | 391,74 | 381-135-400 | 355,89 |
| 139-149 | 391-139-400 | 397,95 | 381-139-400 | 360,46 |
| 145-155 | 391-145-400 | 410,48 | 381-145-400 | 371,41 |
| 159-170 | 391-159-400 | 432,30 | 381-159-400 | 394,82 |
| 167-178 | 391-167-400 | 449,45 | 381-167-400 | 408,88 |
| 176-187 | 391-176-400 | 454,13 | 381-176-400 | 413,56 |
| 193-203 | 391-193-400 | 482,26 | 381-193-400 | 438,52 |
| 215-225 | 391-215-400 | 519,70 | 381-215-400 | 472,87 |

Material: Acero inoxidable AISI 304.

Juntas: EPDM o NBR.



STRAUB CLAMP

ABRAZADERAS DOBLES DE REPARACIÓN / SCZ / LONGITUD 200

| Tolerancia (mm) | Código EPDM | €/Un. EPDM | Código NBR | €/Un. NBR |
|-----------------|-------------|------------|-------------|-----------|
| 88-108 | 392-088-200 | 285,60 | 382-088-200 | 255,97 |
| 100-120 | 392-100-200 | 290,28 | 382-100-200 | 263,78 |
| 108-128 | 392-108-200 | 298,13 | 382-108-200 | 271,53 |
| 114-134 | 392-114-200 | 301,21 | 382-114-200 | 273,12 |
| 120-140 | 392-120-200 | 304,29 | 382-120-200 | 277,79 |
| 130-150 | 392-130-200 | 310,55 | 382-130-200 | 285,60 |
| 140-160 | 392-140-200 | 319,91 | 382-140-200 | 291,81 |
| 159-180 | 392-159-200 | 326,17 | 382-159-200 | 296,49 |
| 168-189 | 392-168-200 | 335,56 | 382-168-200 | 304,29 |
| 190-210 | 392-190-200 | 355,89 | 382-190-200 | 323,09 |
| 210-230 | 392-210-200 | 369,86 | 382-210-200 | 337,06 |
| 218-238 | 392-218-200 | 385,48 | 382-218-200 | 351,12 |
| 240-260 | 392-240-200 | 411,97 | 382-240-200 | 373,04 |
| 269-289 | 392-269-200 | 482,26 | 382-269-200 | 438,52 |
| 282-302 | 392-282-200 | 497,87 | 382-282-200 | 452,58 |
| 315-335 | 392-315-200 | 521,24 | 382-315-200 | 474,45 |

Material: Acero inoxidable AISI 304.

Juntas: EPDM o NBR.



STRAUB CLAMP

ABRAZADERAS DOBLES DE REPARACIÓN / SCZ / LONGITUD 300

| Tolerancia (mm) | Código EPDM | €/Un. EPDM | Código NBR | €/Un. NBR |
|-----------------|-------------|------------|-------------|-----------|
| 88-108 | 392-088-300 | 411,97 | 382-100-300 | 385,48 |
| 100-120 | 392-100-300 | 422,96 | 382-108-300 | 750,50 |
| 108-128 | 392-108-300 | 427,63 | 382-114-300 | 402,67 |
| 114-134 | 392-114-300 | 441,69 | 382-120-300 | 408,88 |
| 120-140 | 392-120-300 | 449,45 | 382-130-300 | 413,56 |
| 130-150 | 392-130-300 | 454,13 | 382-140-300 | 427,63 |
| 140-160 | 392-140-300 | 471,32 | 382-159-300 | 438,52 |
| 159-180 | 392-159-300 | 482,26 | 382-168-300 | 452,58 |
| 168-189 | 392-168-300 | 497,87 | 382-190-300 | 474,45 |
| 190-210 | 392-190-300 | 521,24 | 382-210-300 | 494,74 |
| 210-230 | 392-210-300 | 543,12 | 382-218-300 | 505,63 |
| 218-238 | 392-218-300 | 558,72 | 382-240-300 | 543,12 |
| 240-260 | 392-240-300 | 599,28 | 382-269-300 | 639,80 |
| 269-289 | 392-269-300 | 703,89 | 382-282-300 | 660,19 |
| 282-302 | 392-282-300 | 727,29 | 382-315-300 | 685,09 |
| 315-335 | 392-315-300 | 753,79 | 382-315-300 | 685,09 |
| 322-344 | 392-322-300 | 764,68 | 382-322-300 | 696,03 |
| 337-358 | 392-337-300 | 785,02 | 382-337-300 | 711,64 |
| 347-367 | 392-347-300 | 794,36 | 382-347-300 | 722,53 |

Material: Acero inoxidable AISI 304.

Juntas: EPDM o NBR.



STRAUB CLAMP

ABRAZADERAS DOBLES DE REPARACIÓN / SCZ / LONGITUD 400

| Tolerancia (mm) | Código EPDM | €/Un. EPDM | Código NBR | €/Un. NBR |
|-----------------|-------------|------------|-------------|-----------|
| 88-108 | 392-088-400 | 538,39 | 382-088-400 | 488,48 |
| 100-120 | 392-100-400 | 555,54 | 382-100-400 | 504,08 |
| 108-128 | 392-108-400 | 561,81 | 382-108-400 | 511,89 |
| 114-134 | 392-114-400 | 572,75 | 382-114-400 | 519,70 |
| 120-140 | 392-120-400 | 585,22 | 382-120-400 | 532,23 |
| 130-150 | 392-130-400 | 594,62 | 382-130-400 | 540,03 |
| 140-160 | 392-140-400 | 613,30 | 382-140-400 | 557,18 |
| 159-180 | 392-159-400 | 628,96 | 382-159-400 | 572,75 |
| 168-189 | 392-168-400 | 639,80 | 382-168-400 | 580,54 |
| 190-210 | 392-190-400 | 682,01 | 382-190-400 | 619,57 |
| 210-230 | 392-210-400 | 711,64 | 382-210-400 | 647,66 |
| 218-238 | 392-218-400 | 728,79 | 382-218-400 | 661,68 |
| 240-260 | 392-240-400 | 789,68 | 382-240-400 | 717,95 |
| 269-289 | 392-269-400 | 917,64 | 382-269-400 | 834,93 |
| 282-302 | 392-282-400 | 947,28 | 382-282-400 | 861,52 |
| 315-335 | 392-315-400 | 972,28 | 382-315-400 | 883,35 |
| 322-344 | 392-322-400 | 991,02 | 382-322-400 | 902,09 |
| 337-358 | 392-337-400 | 1.020,65 | 382-337-400 | 928,58 |
| 347-367 | 392-347-400 | 1.048,75 | 382-347-400 | 950,41 |
| 365-385 | 392-365-400 | 1.090,85 | 382-365-400 | 991,02 |
| 390-410 | 392-390-400 | 1.131,46 | 382-390-400 | 1.028,51 |
| 410-430 | 392-410-400 | 1.159,55 | 382-410-400 | 1.055,01 |
| 420-440 | 392-420-400 | 1.176,76 | 382-420-400 | 1.069,07 |

Material: Acero inoxidable AISI 304.

Juntas: EPDM o NBR.

0811 (0809*)

Accesorios

Conectores

Accesorios para válvulas manuales

Actuadores y accesorios

Accesorios válvulas de membrana (*)

0811

Recambios

Válvulas manuales

Válvulas automáticas

Uniones 3 piezas

Flujómetros



Accesorios y recambios

INDUSTRIA





Accesorio y recambios





INDUSTRIA

Accesorios**Conectores / Accesorios para válvulas manuales****CVDE**

| d | Ref. | Para válvulas | € |
|-----|--------------|-----------------------------|-------|
| 20 | CVDE11020 | | 6,05 |
| 25 | CVDE11025 | | 6,18 |
| 32 | CVDE11032 | VKD-VKR-TKD | 6,28 |
| 40 | CVDE11040 | VEE-VXE-SXE SSE-RV-VV-VR | 9,83 |
| 50 | CVDE11050 | | 11,67 |
| 63 | CVDE11063 | | 16,56 |
| 75 | CVDE11075 | VKD-VEE-VXE-SX/SSE | 46,57 |
| 90 | CVDE11090 | VKD | 60,53 |
| 90 | CVDE11090VXE | VEE-VXE-SXE-SSE | 60,53 |
| 110 | CVDE11110 | VKD | 69,73 |
| 110 | CVDE11110VXE | VEE-VXE-SXE-SSE | 70,41 |

Conector final en PE100 SDR11.

Para soldadura a testa o electrofusión.**Q/BBE-L**

| d | Ref. | Para válvulas | € |
|----|------------|---------------|-------|
| 20 | QBBEL11020 | DK | 8,39 |
| 25 | QBBEL11025 | DK | 9,88 |
| 32 | QBBEL11032 | DK | 12,58 |
| 40 | QBBEL11040 | DK | 16,03 |
| 50 | QBBEL11050 | DK | 16,56 |
| 63 | QBBEL11063 | DK | 24,11 |

Conector final en PE100 SDR11.

*Para soldadura a testa o electrofusión.***ACCESORIOS PARA VÁLVULAS MANUALES****MANGUITO**

| d | Ref. | DN | € PVC-U |
|-----|---------------|-----|---------|
| 16 | ENDIV016 | 10 | 6,55 |
| 20 | ENDIV020 | 15 | 6,55 |
| 25 | ENDIV025 | 20 | 7,85 |
| 32 | ENDIV032 | 25 | 8,93 |
| 40 | ENDIV040 | 32 | 10,69 |
| 50 | ENDIV050 | 40 | 12,33 |
| 63 | ENDIV063 | 50 | 16,19 |
| 75 | ENDIV075 | 65 | 29,37 |
| 90 | ENDIV090 | 80 | 36,37 |
| 90 | ENDIV090VXE * | 80 | 36,37 |
| 110 | ENDIV110 | 100 | 61,43 |
| 110 | ENDIV110VXE * | 100 | 61,43 |

Manguito encolar H.

*Para válvulas VKD-VKR-TKD-VXE-VEE-SXE-SSE-RV-VR-VV.*** Para válvulas VEE-VXE-SXE-SSE.*

Para recambios de las válvulas consultar el último apartado "Recambios" de esta misma tarifa.

**MANGUITO**

| d | Ref. | DN | € PVC-U |
|-----|----------|-----|---------|
| 16 | ENDDV016 | 10 | 6,49 |
| 20 | ENDDV020 | 15 | 6,55 |
| 25 | ENDDV025 | 20 | 7,85 |
| 32 | ENDDV032 | 25 | 8,93 |
| 40 | ENDDV040 | 32 | 10,69 |
| 50 | ENDDV050 | 40 | 12,33 |
| 63 | ENDDV063 | 50 | 16,19 |
| 75 | ENDDV075 | 65 | 28,52 |
| 90 | ENDDV090 | 80 | 35,26 |
| 110 | ENDDV110 | 100 | 61,43 |

Manguito encolar M.

Para válvulas VKD-VKR-TKD-VXE-VEE-SXE-SSE-RV-VR-VV.

**PSKD**

| d | Ref. | DN | Ø tubo | € |
|-------|---------|-------|--------|-------|
| 16-20 | PSKD020 | 10-15 | 25 | 45,17 |
| 25 | PSKD025 | 20 | 25 | 46,19 |
| 32 | PSKD032 | 25 | 25 | 47,37 |
| 40 | PSKD040 | 32 | 32 | 47,89 |
| 50 | PSKD050 | 40 | 32 | 49,83 |
| 63 | PSKD063 | 50 | 32 | 54,98 |

Eje de extensión.

Tubo no incluido.

Para válvulas de bola VKD-VKR-TKD.

**Power Quick/CP**

| d | Ref. | DN | ISO | Cuadrado | € |
|-------|------------|-------|---------|----------|-------|
| 16-20 | PQCP020 | 10-15 | F03-04+ | 11 | 42,74 |
| 25 | PQCP025 | 20 | F03-05+ | 11 | 45,38 |
| 25 | PQCP025F04 | 20 | F04 | 11 | 39,41 |
| 32 | PQCP032 | 25 | F03-05+ | 11 | 45,38 |
| 32 | PQCP032F04 | 25 | F04 | 11 | 39,41 |
| 40 | PQCP040 | 32 | F05-07+ | 14 | 51,87 |
| 50 | PQCP050 | 40 | F05-07+ | 14 | 51,87 |
| 63 | PQCP063 | 50 | F05-07+ | 14 | 55,11 |

Kit de actuación neumático.

Para válvulas VKD-VKR-TKD.

+ Para final de carrera tipo MSKD.

**MANGUITO**

| d | Ref. | DN | € PVC-U |
|--------|---------------|-----|---------|
| 3/8" | ENDFV038 | 10 | 6,55 |
| 1/2" | ENDFV012 | 15 | 6,55 |
| 3/4" | ENDFV034 | 20 | 7,85 |
| 1" | ENDFV100 | 25 | 8,93 |
| 1 1/4" | ENDFV114 | 32 | 10,69 |
| 1 1/2" | ENDFV112 | 40 | 12,33 |
| 2" | ENDFV200 | 50 | 16,19 |
| 2 1/2" | ENDFV212 | 65 | 28,52 |
| 3" | ENDFV300 | 80 | 35,26 |
| 3" | ENDFV300VXE * | 80 | 35,26 |
| 4" | ENDFV400 | 100 | 60,83 |
| 4" | ENDFV400VXE * | 100 | 60,83 |

Manguito roscar H.

Para válvulas VKD-VKR-TKD-VXE-VEE-SXE-SSE-RV-VR-VV.

* Para válvulas VEE-VXE-SXE-SSE.

VKD

| d | Ref. | DN | € |
|--------|-------------|--------|-------|
| 75-110 | AKVKD075110 | 65-100 | 71,31 |

Kit de actuación.

Adaptador para actuador.

Para válvulas de bola VKD.

FK

| d | Ref. | DN | € |
|--------|----------|--------|-------|
| 50-160 | FKADA160 | 40-150 | 25,53 |
| 225 | FKADA225 | 200 | 31,05 |

Kit de actuación.

Adaptador para actuador.

Para válvulas de mariposa FK.

**Power Quick/CE**

| d | Ref. | DN | ISO | Cuadrado | € |
|-------|------------|-------|--------|----------|-------|
| 16-20 | PQCE020 | 10-15 | F03-04 | 14 | 43,16 |
| 25 | PQCE025 | 20 | F03-05 | 14 | 45,82 |
| 25 | PQCE025F04 | 20 | F04 | 14 | 39,41 |
| 32 | PQCE032 | 25 | F03-05 | 14 | 45,38 |
| 32 | PQCE032F04 | 25 | F04 | 14 | 39,41 |
| 40 | PQCE040 | 32 | F05-07 | 14 | 52,38 |
| 50 | PQCE050 | 40 | F05-07 | 14 | 52,38 |
| 63 | PQCE063 | 50 | F05-07 | 14 | 55,11 |

Kit de actuación eléctrico.

Para válvulas VKD-VKR-TKD.

Bajo pedido disponemos también de otras medidas y/o estándares, como encolar BS, ASTM, JIS; y roscar NPT y JIS para todas las válvulas.



Power Quick

| d | Ref. | DN | € |
|-----|--------|-----|--------|
| 75 | PQE090 | 65 | 132,45 |
| 90 | PQE090 | 80 | 132,45 |
| 110 | PQE110 | 100 | 145,68 |

Adaptador para actuador eléctrico y neumático.

Para válvulas de bola VKD.



LS QUICK KIT

| d | Ref. | DN | € |
|-------|----------|-------|-------|
| 16-20 | LSQKIT20 | 10-15 | 62,42 |
| 25 | LSQKIT25 | 20 | 66,06 |
| 32 | LSQKIT32 | 25 | 66,06 |
| 40 | LSQKIT40 | 32 | 75,53 |
| 50 | LSQKIT50 | 40 | 75,53 |
| 63 | LSQKIT63 | 50 | 80,25 |

Accesorios de conexión para final de carrera LSQT.

Para válvulas VKD-TKD.



LS QUICK KIT

| d | Ref. | DN | € |
|-----|-------------|-----|--------|
| 75 | LSQKIT75160 | 65 | 151,98 |
| 90 | LSQKIT75160 | 80 | 151,98 |
| 110 | LSQKIT75160 | 100 | 151,98 |

Accesorios de conexión para final de carrera LSQT.

Para válvulas VKD.



PMKD

| d | Ref. | DN | € |
|-------|-------|-------|-------|
| 16-32 | PMKD1 | 10-25 | 11,11 |
| 40-63 | PMKD2 | 32-50 | 12,12 |

Pletinas de sujeción.

Para válvulas de bola VKD-VKR.



SOPORTE*

| d | Ref. | DN | € |
|-------|------------|-------|--------|
| 16-20 | PQCECP020D | 10-15 | 68,86 |
| 25 | PQCECP025D | 20 | 68,86 |
| 32 | PQCECP032D | 25 | 68,86 |
| 40 | PQCECP040D | 32 | 71,43 |
| 50 | PQCECP050D | 40 | 100,06 |
| 63 | PQCECP063D | 50 | 100,06 |

Kit de actuación eléctrico y neumático.

Para válvulas VKD-VKR-TKD.



LS QUICK KIT

| d | Ref. | DN | € |
|-----|---------------|-----|--------|
| 50 | LSQKITFK5063 | 40 | 144,71 |
| 63 | LSQKITFK5063 | 50 | 144,71 |
| 75 | LSQKITFK75160 | 65 | 190,72 |
| 90 | LSQKITFK75160 | 80 | 190,72 |
| 110 | LSQKITFK75160 | 100 | 190,72 |
| 140 | LSQKITFK75160 | 125 | 190,72 |
| 160 | LSQKITFK75160 | 150 | 190,72 |
| 225 | LSQKIT225 | 200 | 163,82 |

Accesorios de conexión para final de carrera LSQT.

Para válvulas FK.



FINALES DE CARRERA

| d | Ref. | DN | € |
|-------|---------|-------|--------|
| Todos | LSQTMEC | Todos | 196,06 |

Finales de carrera ELECTROMECÁNICOS IP67.

Para válvulas VKD-TKD-FK.

| d | Ref. | DN | € |
|-------|---------|-------|--------|
| Todos | LSQTPNP | Todos | 330,87 |

Finales de carrera Inductivos PNP (3 hilos).

Para válvulas VKD-TKD-FK.



PMKD KIT

| d | Ref. | DN | € |
|-------|----------|-------|-------|
| 16-32 | KITPMKD1 | 10-25 | 15,90 |
| 40-63 | KITPMKD2 | 32-50 | 16,77 |

Pletinas de sujeción con tornillos e insertos.

Para válvulas de bola VKD-VKR.



INSERTOS

| d | Ref. | DN | € |
|-------|----------|-------|--------|
| 16-32 | SINSM04X | 10-25 | 107,34 |
| 40-63 | SINSM06X | 32-50 | 118,69 |

Insertos roscados en acero inoxidable.

20 piezas. Para válvulas de bola VKD-VKR.



LCE

| d | Ref. | DN | € |
|-------|--------|-------------------------|-------|
| 16-20 | LCE020 | 10-15 | 29,61 |
| 25 | LCE025 | 20 | 29,73 |
| 32 | LCE032 | 25 | 31,65 |
| 40 | LCE040 | 32 | 32,67 |
| 50 | LCE050 | 40 | 33,81 |
| 63 | LCE063 | 50-65-80-110(VXE y SSE) | 43,59 |

Tapón + Disco para VEE, VXE, SXE y SSE.

Tapón transparente y disco en PVC blanco.



PSE

| d | Ref. | DN | Ø tubo | € |
|-----|--------|-----|--------|-------|
| 75 | PSE090 | 65 | 63 | 83,69 |
| 90 | PSE090 | 80 | 63 | 83,69 |
| 110 | PSE110 | 100 | 63 | 83,69 |

Eje de extensión para válvula de bola VEE-VXE.

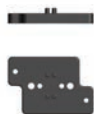

PMDK KIT

| d | Ref. | DN | € |
|-------|----------|-------|-------|
| 20-32 | KITPMDK1 | 15-25 | 28,77 |
| 40-75 | KITPMDK2 | 32-65 | 27,81 |

Para válvula de membrana DK.

Paletinas de sujeción con tornillos e insertos.



SHKD

| d | Ref. | DN | € |
|-------|---------|-------|-------|
| 16-20 | SHKD020 | 10-15 | 20,97 |
| 25-32 | SHKD032 | 20-25 | 23,42 |
| 40-50 | SHKD050 | 32-40 | 27,17 |
| 63 | SHKD063 | 50 | 29,08 |

Kit de seguridad.

Para válvula VKD y TDK (maneta no incluida).



LSE

| d | Ref. | DN | A | B | € |
|-------|--------|-------|----|-----|-------|
| 16-20 | LSE020 | 10-15 | 10 | 500 | 99,78 |
| 25 | LSE025 | 20 | 10 | 500 | 99,78 |
| 32 | LSE032 | 25 | 10 | 500 | 99,78 |
| 40 | LSE040 | 32 | 10 | 500 | 99,78 |
| 50 | LSE050 | 40 | 10 | 400 | 99,78 |
| 63 | LSE063 | 50 | 10 | 400 | 99,78 |

Etiquetas para VEE y VXE.

Etiquetas blancas troqueladas.

A = Número de hojas
B = Total etiquetas



PMDK

| d | Ref. | DN | € |
|-------|-------|-------|-------|
| 20-32 | PMDK1 | 15-25 | 22,26 |
| 40-75 | PMDK2 | 32-65 | 25,84 |

Para válvula de membrana DK.

Paletinas de sujeción.



ZPL

| d | Ref. | DN | € |
|-------|------------|-------|-------|
| 16-20 | ZPL2415002 | 12-15 | 21,71 |

Plato separador para válvulas de membrana CM



Para válvulas de bola 2 vías VKD.



| Ref. 12 V | ACTUACIÓN ELÉCTRICA 24-240 V AC/DC | | | | ACTUACIÓN NEUMÁTICA ALUMINIO | | | | ACTUACIÓN NEUMÁTICA POLIAMIDA | | | |
|-----------|---------------------------------------|----------|--------|----------|------------------------------|--------|---------------|--------|-------------------------------|--------|---------------|--------|
| | AC/DC | € | Ref. | € | DOBLE EFECTO | | SIMPLE EFECTO | | DOBLE EFECTO | | SIMPLE EFECTO | |
| 16 | J4CB20 | 527,72 | J4CS20 | 527,72 | CHC052 | 169,77 | CHC052SR | 201,40 | PPW | 186,41 | PPWS | 210,48 |
| 20 | J4CB20 | 527,72 | J4CS20 | 527,72 | CHC052 | 169,77 | CHC052SR | 201,40 | PPW | 186,41 | PPWS | 210,48 |
| 25 | J4CB20 | 527,72 | J4CS20 | 527,72 | CHC052 | 169,77 | CHC052SR | 201,40 | PPW | 186,41 | PPWS | 210,48 |
| 32 | J4CB20 | 527,72 | J4CS20 | 527,72 | CHC052 | 169,77 | CHC052SR | 201,40 | PPW | 186,41 | PP00S | 318,71 |
| 40 | J4CB20 | 527,72 | J4CS20 | 527,72 | CHC052 | 169,77 | CHC052SR | 201,40 | PPW | 186,41 | PP00S | 318,71 |
| 50 | J4CB20 | 527,72 | J4CS20 | 527,72 | CHC052 | 169,77 | CHC063SR | 260,13 | PPW | 186,41 | PP10S | 445,01 |
| 63 | J4CB20 | 527,72 | J4CS20 | 527,72 | CHC052 | 169,77 | CHC075SR | 339,00 | PP10 | 375,83 | PP10S | 445,01 |
| 75 | J4CB55 | 797,77 | J4CS55 | 797,77 | CHC075 | 268,06 | CHC083SR | 387,80 | PP10 | 375,83 | PP20S | 631,42 |
| 90 | J4CB55 | 797,77 | J4CS55 | 797,77 | CHC075 | 268,06 | CHC083SR | 387,80 | PP10 | 375,83 | PP20S | 631,42 |
| 110 | J4CB85 | 1.172,04 | J4CS85 | 1.172,04 | CHC083 | 294,87 | CHC105SR | 718,84 | PP10 | 375,83 | PP20S | 631,42 |

Para válvulas de bola 3 vías TKD.

| | | | | | | | | | | | | |
|----|--------|--------|--------|--------|--------|--------|----------|--------|------|--------|-------|--------|
| 16 | J4CB20 | 527,72 | J4CS20 | 527,72 | CHC052 | 169,77 | CHC052SR | 201,40 | PPW | 186,41 | PPWS | 210,48 |
| 20 | J4CB20 | 527,72 | J4CS20 | 527,72 | CHC052 | 169,77 | CHC052SR | 201,40 | PPW | 186,41 | PPWS | 210,48 |
| 25 | J4CB20 | 527,72 | J4CS20 | 527,72 | CHC052 | 169,77 | CHC052SR | 201,40 | PPW | 186,41 | PPWS | 210,48 |
| 32 | J4CB20 | 527,72 | J4CS20 | 527,72 | CHC052 | 169,77 | CHC052SR | 201,40 | PPW | 186,41 | PP00S | 318,71 |
| 40 | J4CB20 | 527,72 | J4CS20 | 527,72 | CHC052 | 169,77 | CHC063SR | 260,13 | PPW | 186,41 | PP10S | 445,01 |
| 50 | J4CB20 | 527,72 | J4CS20 | 527,72 | CHC063 | 205,52 | CHC075SR | 339,00 | PP00 | 285,67 | PP10S | 445,01 |
| 63 | J4CB20 | 527,72 | J4CS20 | 527,72 | CHC063 | 205,52 | CHC075SR | 339,00 | PP10 | 375,83 | PP10S | 445,01 |

Para válvulas de mariposa FE.

| | | | | | | | | | | | | |
|-----|---------|----------|---------|----------|--------|----------|----------|----------|--------|----------|---------|----------|
| 50 | J4CB20 | 527,72 | J4CS20 | 527,72 | CHC052 | 169,77 | CHC063SR | 260,13 | PP00 | 285,67 | PP10S | 445,01 |
| 63 | J4CB20 | 527,72 | J4CS20 | 527,72 | CHC052 | 169,77 | CHC063SR | 260,13 | PP00 | 285,67 | PP10S | 445,01 |
| 75 | J4CB55 | 797,77 | J4CS55 | 797,77 | CHC063 | 205,52 | CHC075SR | 339,00 | PP00 | 285,67 | PP10S | 445,01 |
| 90 | J4CB55 | 797,77 | J4CS55 | 797,77 | CHC075 | 268,06 | CHC083SR | 387,80 | PP10 | 375,83 | PP10S | 445,01 |
| 110 | J4CB55 | 797,77 | J4CS55 | 797,77 | CHC075 | 268,06 | CHC105SR | 718,84 | PP10 | 375,83 | PP20S | 631,42 |
| 140 | J4CB85 | 1.172,04 | J4CS85 | 1.172,04 | CHC083 | 294,87 | CHC125SR | 972,27 | PP10 | 375,83 | PA25S * | 917,06 |
| 160 | J4CB140 | 1.423,75 | J4CS140 | 1.423,75 | CHC083 | 294,87 | CHC125SR | 972,27 | PP20 | 702,01 | PA25S * | 917,06 |
| 225 | J4CB300 | 1.546,47 | J4CS300 | 1.546,47 | CHC105 | 554,02 | CHC140SR | 1.483,75 | PP20 | 702,01 | PA30S * | 1.353,16 |
| 280 | J4CB300 | 1.546,47 | J4CS300 | 1.546,47 | CHC125 | 732,69 | CHC190SR | 2.703,68 | PA30 * | 1.345,68 | P40ST * | 3.674,48 |
| 315 | J4CB300 | 1.546,47 | J4CS300 | 1.546,47 | CHC140 | 1.000,78 | CHC210SR | 3.722,55 | PA30 * | 1.345,68 | P40ST * | 3.674,48 |

Para válvulas de mariposa FK.

| | | | | | | | | | | | | |
|-----|-------------|-----------|--------------|-----------|---------|-----------|-----------|-----------|--------|----------|---------|----------|
| 50 | J4CB20 | 527,72 | J4CS20 | 527,72 | CHC052 | 169,77 | CHC063SR | 260,13 | PP00 | 285,67 | PP10S | 445,01 |
| 63 | J4CB20 | 527,72 | J4CS20 | 527,72 | CHC052 | 169,77 | CHC063SR | 260,13 | PP00 | 285,67 | PP10S | 445,01 |
| 75 | J4CB55 | 797,77 | J4CS55 | 797,77 | CHC063 | 205,52 | CHC075SR | 339,00 | PP00 | 285,67 | PP10S | 445,01 |
| 90 | J4CB55 | 797,77 | J4CS55 | 797,77 | CHC075 | 268,06 | CHC083SR | 387,80 | PP10 | 375,83 | PP10S | 445,01 |
| 110 | J4CB55 | 797,77 | J4CS55 | 797,77 | CHC075 | 268,06 | CHC105SR | 718,84 | PP10 | 375,83 | PP20S | 631,42 |
| 140 | J4CB85 | 1.172,04 | J4CS85 | 1.172,04 | CHC083 | 294,87 | CHC125SR | 972,27 | PP10 | 375,83 | PA25S * | 917,06 |
| 160 | J4CB140 | 1.423,75 | J4CS140 | 1.423,75 | CHC083 | 294,87 | CHC125SR | 972,27 | PP20 | 702,01 | PA25S * | 917,06 |
| 225 | J4CB300 | 1.546,47 | J4CS300 | 1.546,47 | CHC105 | 554,02 | CHC140SR | 1.483,75 | PP20 | 702,01 | PA30S * | 1.353,16 |
| 280 | J4CB300 | 1.546,47 | J4CS300 | 1.546,47 | CHC125 | 732,69 | CHC190SR | 2.703,68 | PA30 * | 1.345,68 | P40ST * | 3.674,48 |
| 315 | J4CB300 | 1.546,47 | J4CS300 | 1.546,47 | CHC140 | 1.000,78 | CHC210SR | 3.722,55 | PA30 * | 1.345,68 | P40ST * | 3.674,48 |
| 355 | ITQ-0800-24 | Consultar | ITQ-0800-220 | Consultar | CHCN160 | Consultar | CHCN210SR | Consultar | | | | |
| 400 | ITQ-1100-24 | Consultar | ITQ-1100-220 | Consultar | CHCN160 | Consultar | CHCN240SR | Consultar | | | | |

* 24V AC/DC ** 80-240V AC/DC La válvula de mariposa de 140 es la misma que la de 125. Lo mismo sucede con la de 225-200 y la de 280- 250 * Actuadores de aluminio

Reductor manual para válvulas de mariposa FE y FK.

50 - 225 ILG/D-232/10 797,77

250 - 315 ILG/D-550 1.027,56



| Ref. | Modelo | € |
|----------------|--|---------------|
| BSR2017 | Para válvulas de bola \varnothing 16 - 63 mm. | 554,69 |
| BSR2017 | Para válvulas de bola \varnothing 75 - 90 y mariposa \varnothing 50 - 110 mm. | 554,69 |
| BSR2005 | Para válvulas de bola \varnothing 110 mm. y mariposa \varnothing 140 - 315 mm. | 649,09 |
| BSR2017 | Para válvulas de bola 3 vías \varnothing 16 - 63 mm. | 554,69 |

Bloque de seguridad.

Para válvulas con actuador *eléctrico J+J*.

Importe a añadir al precio del actuador.



| Ref. | Modelo | € |
|----------------|--|-----------------|
| DPS2017 | Para válvulas de bola \varnothing 16 - 63 mm. | 619,98 |
| DPS2017 | Para válvulas de bola \varnothing 75 - 90 y mariposa \varnothing 50 - 110 mm. | 619,98 |
| DPS2005 | Para válvulas de bola \varnothing 110 mm. y mariposa \varnothing 140 - 315 mm. | 1.094,55 |
| DPS2017 | Para válvulas de bola 3 vías \varnothing 16 - 63 mm. | 619,98 |

Posicionador 4-20 mA.

Para válvulas con actuador *eléctrico J+J*.

Importe a añadir al precio del actuador.



| Ref. | Modelo | Vías | Voltaje | € |
|---------------------|-------------------------|------|----------|---------------|
| EJ024CA-2008 | Electroválvula J+J 2008 | 5/2 | 24 V CA | 106,22 |
| EJ024CC-2008 | Electroválvula J+J 2008 | 5/2 | 24 V CC | 106,22 |
| EJ048CA-2008 | Electroválvula J+J 2008 | 5/2 | 48 V CA | 106,22 |
| EJ110CA-2008 | Electroválvula J+J 2008 | 5/2 | 110 V CA | 106,22 |
| EJ220CA-2008 | Electroválvula J+J 2008 | 5/2 | 220V CA | 106,22 |

Electroválvula.

Para válvulas con actuador *neumático CH-AIR*.

3/2 vías consultar.



| Ref. | Modelo | € |
|---------------------|---------------------------------------|--------------|
| CB2GC00TAPSS | 2 finales de carrera ELECTROMECAÑICOS | 94,43 |

Caja final de carrera electromecánico.

Para válvulas con actuador *neumático CH-AIR*.

Los precios ya incluyen la instalación y montaje sobre el actuador



| Ref. | Modelo | € |
|---------------------|--|---------------|
| CB2GP23TAPSS | 2 finales de carrera INDUCTIVOS NBB2-V3-E2 3 hilos PNP | 306,87 |
| CB2GP41TAPSS | 2 finales de carrera INDUCTIVOS NBB2-V3-E0 3 hilos NPN | 306,87 |
| CB2GP49TAPS | 2 finales de carrera INDUCTIVOS NBB2-V3-Z4 2 hilos no | 377,43 |

Caja final de carrera inductivo.

Para válvulas con actuador *neumático CH-AIR*.

Los precios ya incluyen la instalación y montaje sobre el actuador

YT-1200



YT-1000



YT-2300



| Ref. | Modelo | € |
|----------------|--|-----------------|
| YT-1200 | Posicionador neumático 3-15 PSI | 1.245,06 |
| YT-1000 | Posicionador electroneumático 4-20 mA | 1.841,05 |
| YT-2300 | Posicionador electroneumático 4-20 mA + FEEDBACK 4-20 mA | 3.369,34 |

Posicionador.

Para válvulas con actuador *neumático CH-AIR*.

Los precios ya incluyen la instalación y montaje sobre el actuador



| Ref. | Modelo | Vías | Voltaje | € |
|--------------------|-----------------------------|----------|----------|---------------|
| EV-500.024A | Electroválvula PRISMA NAMUR | 3/2 -5/2 | 24 V CA | 129,27 |
| EV-500.024C | Electroválvula PRISMA NAMUR | 3/2 -5/2 | 24 V CC | 129,27 |
| EV-500.048A | Electroválvula PRISMA NAMUR | 3/2 -5/2 | 48 V CA | 129,27 |
| EV-500.110A | Electroválvula PRISMA NAMUR | 3/2 -5/2 | 110 V CA | 129,27 |
| EV-500.220A | Electroválvula PRISMA NAMUR | 3/2 -5/2 | 220V CA | 129,27 |

Electroválvula.

Para válvulas con actuador *neumático PRISMA*.



| Ref. | Modelo | € |
|-----------------|---------------------------------------|---------------|
| CFC-5601 | 2 finales de carrera ELECTROMECAÑICOS | 112,92 |
| CFC-5603 | 4 finales de carrera ELECTROMECAÑICOS | 208,76 |

Caja final de carrera electromecánico **aluminio**.

Para válvulas con actuador *neumático PRISMA*.

Los precios ya incluyen la instalación y montaje sobre el actuador.



| Ref. | Modelo | € |
|-----------------|--|---------------|
| CFC-5202 | 2 finales de carrera INDUCTIVOS NAMUR EEXI P+F | 327,57 |
| CFC-5204 | 2 finales de carrera INDUCTIVOS NPN P+F | 651,09 |
| CFC-5206 | 2 finales de carrera INDUCTIVOS PNP P+F | 407,11 |

Caja final de carrera inductivo **aluminio**.

Para válvulas con actuador **neumático PRISMA**.

Los precios ya incluyen la instalación y montaje sobre el actuador



| Ref. | Modelo | € |
|-----------------|--|---------------|
| CFC-6301 | 2 finales de carrera ELECTROMECAÑICOS | 148,42 |
| CFC-6302 | 4 finales de carrera ELECTROMECAÑICOS rec. ORO | 149,69 |

Caja final de carrera electromecánico **plástico**.

Para válvulas con actuador **neumático PRISMA**.

Los precios ya incluyen la instalación y montaje sobre el actuador.



| Ref. | Modelo | € |
|-----------------|--|---------------|
| CFC-6321 | 1 final de carrera INDUCTIVO P+F NBB2-V3-E2 (PNP) | 268,71 |
| CFC-6322 | 2 finales de carrera INDUCTIVOS P+F NBB2-V3-E2 (PNP) | 362,90 |

Caja final de carrera inductivo **plástico**.

Para válvulas con actuador **neumático PRISMA**.

Los precios ya incluyen la instalación y montaje sobre el actuador.



PST-001



PST-003



PST-003

| Ref. | Modelo | € |
|----------------|--|-----------------|
| PST-001 | Posicionador electroneumático 4-20 mA | 1.559,24 |
| PST-002 | Posicionador electroneumático 4-20 mA + 2 finales de carrera SPDT | 1.960,66 |
| PST-003 | Posicionador electroneumático 4-20 mA + 2 finales de carrera SPDT + FEEDBACK 4-20 mA | 2.932,82 |

Posicionador.

Para válvulas con actuador **neumático PRISMA**.

Los precios ya incluyen la instalación y montaje sobre el actuador



INDUSTRIA

Accesorios

Accesorios válvulas de membrana



| DN | Ref. | Tipo de válvula | € |
|--------|---------------|-----------------|--------------|
| 80+100 | ZIN005 | VM/CP NC-NO-DE | 19,28 |

Indicador óptico de posición.
Con junta y tapón protector.



| DN | Ref. | Tipo de válvula | € |
|-------|----------------|-----------------|---------------|
| 15+32 | ZLIM001 | DK/CP NC | 110,11 |
| 15+32 | ZLIM002 | DK/CP NO-DE | 125,47 |
| 40+65 | ZLIM003 | DK/CP NC | 78,65 |
| 40+65 | ZLIM004 | DK/CP NO-DE | 110,11 |

Limitador de carrera.
Con junta y tapón protector.

Apertura manual
(Montaje en fábrica)



| DN | Ref. | Tipo de válvula | € |
|--------|---------------|-----------------|---------------|
| 15+32 | ZLI001 | DK/CP NC | 101,89 |
| 15+32 | ZLI002 | DK/CP NO-DE | 90,80 |
| 40+65 | ZLI003 | DK/CP NC | 115,50 |
| 40+65 | ZLI103 | DK/CP NO-DE | 64,86 |
| 12+15 | ZLI010 | CM/CP NC-NO-DE | 126,65 |
| 80+100 | | VM/CP NC-NO * | |

Limitador de carrera con indicador
óptico de posición.
Con junta y tapón protector.

* Montaje en fábrica



| DN | Ref. | Tipo de válvula | € |
|--------|-------------------|-----------------|---------------|
| 15+32 | LSLIPNP001 | DK/CP | 787,63 |
| 40+65 | LSLIPNP002 | DK/CP | 787,63 |
| 80+100 | LSLIPNP003 | VM/CP NC | 787,63 |
| 80+100 | LSLIPNP001 | VM/CP NO-DA | 787,63 |

Caja finales de carrera inductivos LSLI.

IP68. 2 Conectores electromecánicos.



| DN | Ref. | Tipo de válvula | € |
|--------|------------------|-----------------|-----------------|
| 15+65 | ZMSNAM001 | DK/CP NC-NO-DE | 518,90 |
| 80+100 | ZMSNAM004 | VM/CP NC | 544,51 |
| 80 | ZMSNAM005 | VM/CP NO-DE | 544,51 |
| 100 | ZMSNAM006 | VM/CP NO-DE | 1.063,79 |

Caja micro contactos.

IP65. Seguridad: Eex ia IIC T6.

2 Conectores inductivos NAMUR.



| DN | Ref. | Tipo de válvula | € |
|--------|-------------------|-----------------|---------------|
| 15+32 | LSLIMEC001 | DK/CP | 437,59 |
| 40+65 | LSLIMEC002 | DK/CP | 437,59 |
| 80+100 | LSLIMEC003 | VM/CP NC | 437,59 |
| 80+100 | LSLIMEC001 | VM/CP NO-DA | 437,59 |

Caja finales de carrera electromecánicos

LSLI.

IP67. 2 Conectores electromecánicos.



| DN | Ref. | Tipo de válvula | € |
|-------|-----------------|-----------------|---------------|
| 12+15 | ZMSMECCM | CM/CP NC-NO-DE | 385,22 |

Caja micro contactos.

IP65. 2 Conectores electromecánicos.

| | | | |
|-------|-----------------|----------------|---------------|
| 12+15 | ZMSNAMCM | CM/CP NC-NO-DE | 880,49 |
|-------|-----------------|----------------|---------------|

Caja micro contactos.

IP65. Seguridad: Eex ia IIC T6.

2 Conectores inductivos NAMUR.



| DN | Ref. | Tipo de válvula | € |
|-------|---------------------|-----------------|-----------------|
| 15+32 | ZMSPNPLIM001 | DK/CP NC | 1.376,47 |
| 40 | ZMSPNPLIM002 | DK/CP NC | 983,19 |
| 50+65 | ZMSPNPLIM003 | DK/CP NC | 1.376,47 |
| 80 | ZMSPNPLIM005 | VM/CP NC | 1.584,74 |
| 100 | ZMSPNPLIM006 | VM/CP NC | 1.376,47 |

Caja micro contactos.

IP65. 2 Sensores inductivos PNP 3 hilos.

Con limitador de carrera.



| DN | Ref. | Tipo de válvula | € |
|--------|-----------------|-----------------|--------------|
| 15+32 | ZMSFC001 | DK/CP NC | 71,54 |
| 40+65 | ZMSFC002 | DK/CP NC | 51,11 |
| 80+100 | ZMSFC005 | VM/CP NC | 71,54 |
| 12+15 | ZMSFC009 | CM/CP NC-NO-DE | 71,54 |

Caja micro contactos (24.90).

IP65. 1 Conector electromecánico.



| DN | Ref. | Tipo de válvula | € |
|--------|------|-----------------|-----------------|
| 15+65 | | DK/CP NC-NO* | 1.813,21 |
| 80+100 | | VM/CP NC-NO* | 1.813,21 |

Posicionador electroneumático.

* Montaje en fábrica

SIMPLE EFECTO.

Señal input 4-20 mA. Para válvulas NC-NO.



| DN | Ref. | Tipo de válvula | € |
|--------|------|-----------------|-----------------|
| 15+65 | | DK/CP DE* | 2.236,45 |
| 80+100 | | VM/CP DE* | 2.236,45 |

Posicionador electroneumático.

* Montaje en fábrica

DOBLE EFECTO.

Señal input 4-20 mA. Para válvulas DE.



| DN | Ref. | Tipo de válvula | € |
|--------|---------------|-----------------|---------------|
| 15+65 | ZMS001 | DK/CP NC-NO-DE | 626,78 |
| 80 | ZMS001 | VM/CP NC | 626,78 |
| 12-15 | ZMS001 | VM/CP NO-DA | 626,78 |
| 80-100 | ZMS002 | CM/CP | 626,78 |

Caja micro contactos libres.

IP67. 2 Sensores libres.

| Ref. | Cable conexión | € |
|---------------|----------------|--------------|
| 3CNZMS | 5 metros | 48,14 |

Conector "5 conectores" PIN M12 x 1

Para contactos libres.



| Ref. | Tipo de válvula | € |
|---------------------|--|---------------|
| SPNC14N024DC | DK-DKB-DKD-VM-CM/CP Voltaje 24V DC | 210,96 |
| SPNC14N024AC | DK-DKB-DKD-VM-CM/CP Voltaje 24V AC 50 Hz | 210,96 |
| SPNC14N110AC | DK-DKB-DKD-VM-CM/CP Voltaje 110V AC 50 Hz | 210,96 |
| SPNC14N220AC | DK-DKB-DKD-VM-CM/CP Voltaje 220V AC 50 Hz | 210,96 |

Válvula piloto SP/NC normalmente cerrada.

Juntas NBR. 3/2 vías.

Rosca H 1/4". Montaje directo.



| Ref. | Tipo de válvula | € |
|---------------------|--|---------------|
| SBNC18N024DC | DK-DKB-DKD-VM-CM/CP Voltaje 24V DC | 191,29 |
| SBNC18N024AC | DK-DKB-DKD-VM-CM/CP Voltaje 24V AC 50 Hz | 191,29 |
| SBNC18N110AC | DK-DKB-DKD-VM-CM/CP Voltaje 110V AC 50 Hz | 191,29 |
| SBNC18N220AC | DK-DKB-DKD-VM-CM/CP Voltaje 220V AC 50 Hz | 191,29 |

Válvula piloto SP/NC normalmente cerrada.

Juntas NBR. 3/2 vías.

Rosca H 1/4". Montaje en batería.



| Ref. | Tipo de válvula | € |
|---------------------|------------------------------------|---------------|
| SDNO14N024DC | DK-DKB-DKD-CM/CP Voltaje 24V DC | 281,58 |

Válvula piloto SD/NO normalmente abierta.

Juntas NBR. 3/2 vías.

Rosca H 1/4". Montaje directo.



| Ref. | Tipo de válvula | € |
|---------------------|------------------------------------|---------------|
| SMNO18N024DC | DK-DKB-DKD-CM/CP Voltaje 24V DC | 283,64 |

Válvula piloto SM/NO normalmente abierta.

Juntas NBR. 3/2 vías.

Rosca H 1/8". Montaje en batería.



| Ref. | Tipo de válvula | € |
|-----------------|-------------------------------------|---------------|
| 2EV024DC | DK-DKB/CP* Voltaje 24V | 193,17 |
| 2EV024AC | DK-DKB/CP* Voltaje 24V AC 50 Hz | 193,17 |
| 2EV110AC | DK-DKB/CP* Voltaje 110V AC 50 Hz | 193,17 |
| 2EV220AC | DK-DKB/CP* Voltaje 220V AC 50 Hz | 193,17 |

Válvula piloto NAMUR "2EV".
NAMUR 3-5/2 vías. Montaje directo.

* Para montar con adaptador
ZAD2428001



| DN | Ref. | Tipo de válvula | € |
|-------|-------------------|-----------------|--------------|
| 15÷65 | ZAD2428001 | DK/CP | 57,80 |
| 15÷65 | ZAD2428001 | DKB/CP | 57,80 |

Adaptador NAMUR para válvula piloto "2EV".

Conexión NAMUR.

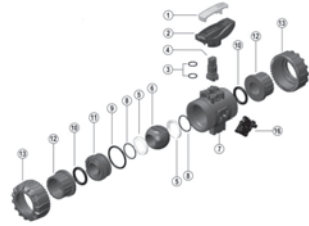

VKD / VKR

Válvula de bola VK DUAL BLOCK® DN10+50.

| d | DN | Ref. EPDM | € | Ref. FKM | € |
|-------|-------|------------|-------|------------|--------|
| 16-20 | 10-15 | SETVKD020E | 22,79 | SETVKD020F | 50,13 |
| 25 | 20 | SETVKD025E | 27,86 | SETVKD025F | 51,79 |
| 32 | 25 | SETVKD032E | 37,77 | SETVKD032F | 58,86 |
| 40 | 32 | SETVKD040E | 51,35 | SETVKD040F | 77,25 |
| 50 | 40 | SETVKD050E | 61,24 | SETVKD050F | 92,48 |
| 63 | 50 | SETVKD063E | 82,08 | SETVKD063F | 157,14 |

Juego de juntas y asientos VKD / VKR.

Posiciones 3-5-8-9-10.

| d | DN | Ref. | € |
|-------|-------|----------|-------|
| 16-20 | 10-15 | HSVKD020 | 16,63 |
| 25 | 20 | HSVKD025 | 18,44 |
| 32 | 25 | HSVKD032 | 19,54 |
| 40 | 32 | HSVKD040 | 20,84 |
| 50 | 40 | HSVKD050 | 23,82 |
| 63 | 50 | HSVKD063 | 30,45 |

Maneta VKD / VKR.
Posiciones 3-5-8-9-10.

Set maneta VKD / VKR
compuesto por maneta y herramienta de apriete

| d | DN | Ref. | € |
|-------|-------|-------------|-------|
| 16-20 | 10-15 | DBVKD020025 | 23,45 |
| 25 | 20 | DBVKD020025 | 23,45 |
| 32 | 25 | DBVKD032 | 23,45 |
| 40 | 32 | DBVKD040050 | 23,45 |
| 50 | 40 | DBVKD040050 | 23,45 |
| 63 | 50 | DBVKD063 | 23,45 |

VKD / VKR DUAL BLOCK® kit.
Posición 16.

| d | DN | Ref. PVC-U | € | Ref. PP-H | € | Ref. PVDF | € | Ref. C-PVC | € |
|-------|-------|------------|-------|-----------|-------|-----------|--------|------------|-------|
| 16-20 | 10-15 | NTVKD020V | 10,22 | NTVKD020M | 13,61 | NTVKD020F | 74,03 | NTVKD020C | 19,54 |
| 25 | 20 | NTVKD025V | 19,33 | NTVKD025M | 25,99 | NTVKD025F | 78,20 | NTVKD025C | 35,78 |
| 32 | 25 | NTVKD032V | 23,37 | NTVKD032M | 31,32 | NTVKD032F | 101,47 | NTVKD032C | 43,92 |
| 40 | 32 | NTVKD040V | 25,09 | NTVKD040M | 34,14 | NTVKD040F | 137,41 | NTVKD040C | 48,78 |
| 50 | 40 | NTVKD050V | 29,68 | NTVKD050M | 40,22 | NTVKD050F | 160,63 | NTVKD050C | 56,94 |
| 63 | 50 | NTVKD063V | 44,95 | NTVKD063M | 61,48 | NTVKD063F | 249,87 | NTVKD063C | 87,79 |

Tuerca VKD / VKR.
Posición 13.

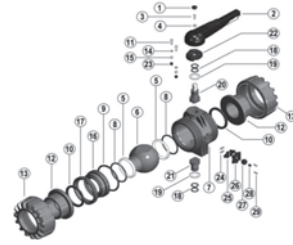

VKD

Válvula de bola VK DUAL BLOCK® DN65+100.

| d | DN | Ref. EPDM | € | Ref. FKM | € |
|-----|-----|-----------------------|---------------|-------------------|---------------|
| 75 | 65 | SETVKD075E | 157,37 | SETVKD075F | 294,39 |
| 90 | 80 | SETVKD090E | 199,74 | SETVKD090F | 387,89 |
| 110 | 100 | SETVKD110E (*) | 270,07 | SETVKD110F | 489,83 |

Juego de juntas y asientos VKD.

Posiciones 5-8-9-10-18-19.

* No recomendable para la válvula VKD d 110 DN100 en PVDF

| d | DN | Ref. | € |
|-----|-----|------------------|--------------|
| 75 | 65 | HSFKD0S14 | 60,19 |
| 90 | 80 | HSFKD0M14 | 76,96 |
| 110 | 100 | HSFKD0L17 | 85,10 |

Maneta VKD.

Posiciones 1-2-3-4.

Set maneta VKD compuesto por maneta y herramienta de apriete

| d | DN | Ref. PVC-U | € | Ref. PP-H | € | Ref. PVDF | € | Ref. C-PVC | € |
|-----|-----|------------------|---------------|------------------|---------------|------------------|-----------------|------------------|---------------|
| 75 | 65 | NTVKD075V | 80,56 | NTVKD075M | 102,47 | NTVKD075F | 504,51 | NTVKD075C | 102,47 |
| 90 | 80 | NTVKD090V | 103,10 | NTVKD090M | 116,34 | NTVKD090F | 997,46 | NTVKD090C | 188,49 |
| 110 | 100 | NTVKD110V | 156,37 | NTVKD110M | 160,78 | NTVKD110F | 1.161,79 | NTVKD110C | 294,95 |

Tuerca VKD.

Posición 13.

| d | DN | Ref. | € |
|--------|--------|--------------------|--------------|
| 75-110 | 65-100 | DBVKD075110 | 34,14 |

VKD DUAL BLOCK® kit.

Posiciones 24-25-26-27-28-29.

| d | DN | Ref. | € |
|--------|--------|----------------|--------------|
| 75-110 | 65-100 | UFFK160 | 30,19 |

Brida superior con trinquete VKD.

Posiciones 11-14-15-22-23.

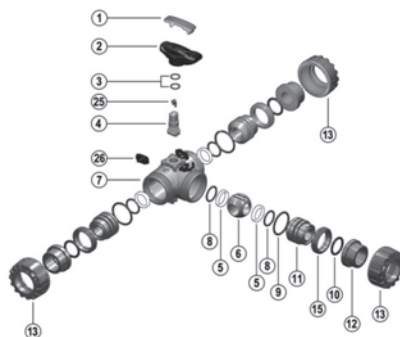

TKD

Válvula de bola 3 vías VK DUAL BLOCK®.

| d | DN | Ref. EPDM | € | Ref. FKM | € |
|-------|-------|------------|-------|------------|--------|
| 16-20 | 10-15 | SETTKD020E | 14,95 | SETTKD020F | 49,22 |
| 25 | 20 | SETTKD025E | 26,07 | SETTKD025F | 68,62 |
| 32 | 25 | SETTKD032E | 28,15 | SETTKD032F | 84,91 |
| 40 | 32 | SETTKD040E | 50,74 | SETTKD040F | 124,02 |
| 50 | 40 | SETTKD050E | 62,96 | SETTKD050F | 200,04 |
| 63 | 50 | SETTKD063E | 83,62 | SETTKD063F | 253,11 |

Juego de juntas y asientos TKD.

Posiciones 3-5-8-9-10.

| d | DN | Ref. | € | d | DN | Ref. | € | d | DN | Ref. | € |
|-------|-------|----------|-------|-------|-------|-------------|-------|-------|-------|-------------|------|
| 16-20 | 10-15 | HSTKD020 | 16,63 | 16-20 | 10-15 | DBTKD020025 | 23,45 | 16-20 | 10-15 | PITKD020 | 2,11 |
| 25 | 20 | HSTKD025 | 18,44 | 25 | 20 | DBTKD020025 | 23,45 | 25 | 20 | PITKD025032 | 2,11 |
| 32 | 25 | HSTKD032 | 19,54 | 32 | 25 | DBTKD032040 | 23,45 | 32 | 25 | PITKD025032 | 2,11 |
| 40 | 32 | HSTKD040 | 20,84 | 40 | 32 | DBTKD032040 | 23,45 | 40 | 32 | PITKD040050 | 2,11 |
| 50 | 40 | HSTKD050 | 23,82 | 50 | 40 | DBTKD050063 | 23,45 | 50 | 40 | PITKD040050 | 2,11 |
| 63 | 50 | HSTKD063 | 30,45 | 63 | 50 | DBTKD050063 | 23,45 | 63 | 50 | PITKD063 | 2,11 |

Maneta TKD.
 Posiciones 1-2.

Maneta y herramienta
 de apriete

TKD DUAL BLOCK® kit.
 Posición 26.

TKD indicador óptico.
 Posición 25.

| d | DN | Ref. PVC-U | € | Ref. PP-H | € | Ref. C-PVC | € |
|-------|-------|------------|-------|-----------|-------|------------|-------|
| 16-20 | 10-15 | NTVKD020V | 10,22 | NTVKD020M | 13,61 | NTVKD020C | 19,54 |
| 25 | 20 | NTVKD025V | 19,33 | NTVKD025M | 25,99 | NTVKD025C | 35,78 |
| 32 | 25 | NTVKD032V | 23,37 | NTVKD032M | 31,32 | NTVKD032C | 43,92 |
| 40 | 32 | NTVKD040V | 25,09 | NTVKD040M | 34,14 | NTVKD040C | 48,78 |
| 50 | 40 | NTVKD050V | 29,68 | NTVKD050M | 40,22 | NTVKD050C | 56,94 |
| 63 | 50 | NTVKD063V | 44,95 | NTVKD063M | 61,48 | NTVKD063C | 87,79 |

Tuerca VKD.
 Posición 13.

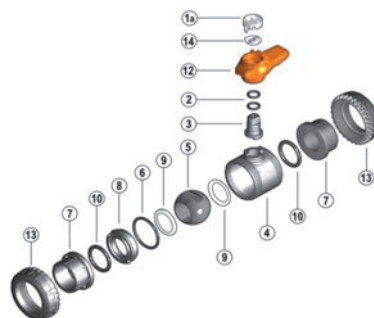

VXE

Válvula de bola VX Easyfit DN15+50.

| d | DN | Ref. EPDM | € | Ref. FKM | € |
|-------|-------|-----------|-------|-----------|--------|
| 16-20 | 10-15 | SETVX020E | 11,14 | SETVX020F | 32,99 |
| 25 | 20 | SETVX025E | 14,71 | SETVX025F | 44,68 |
| 32 | 25 | SETVX032E | 20,87 | SETVX032F | 55,43 |
| 40 | 32 | SETVX040E | 31,43 | SETVX040F | 86,15 |
| 50 | 40 | SETVX050E | 36,44 | SETVX050F | 116,92 |
| 63 | 50 | SETVX063E | 55,54 | SETVX063F | 200,27 |

| d | DN | Ref. | € |
|-------|-------|----------|-------|
| 16-20 | 10-15 | HSVXE020 | 10,62 |
| 25 | 20 | HSVXE025 | 12,58 |
| 32 | 25 | HSVXE032 | 15,82 |
| 40 | 32 | HSVXE040 | 24,67 |
| 50 | 40 | HSVXE050 | 25,25 |
| 63 | 50 | HSVXE063 | 38,16 |

Juego de juntas y asientos VXE.
 Posiciones 2-6-9-10.

Set maneta VXE. Maneta y tapón
 Posiciones 1a-12-14.

| d | DN | Ref. PVC-U | € |
|-------|-------|------------|-------|
| 16-20 | 10-15 | NTVXE020V | 9,74 |
| 25 | 20 | NTVXE025V | 10,96 |
| 32 | 25 | NTVXE032V | 13,15 |
| 40 | 32 | NTVXE040V | 17,29 |
| 50 | 40 | NTVXE050V | 21,34 |
| 63 | 50 | NTVXE063V | 27,81 |

| Ref. C-PVC | € |
|------------|-------|
| NTVXE020C | 16,19 |
| NTVXE025C | 31,03 |
| NTVXE032C | 36,66 |
| NTVXE040C | 39,90 |
| NTVXE050C | 47,70 |
| NTVXE063C | 72,07 |

Tuercas VXE. Posición 13.

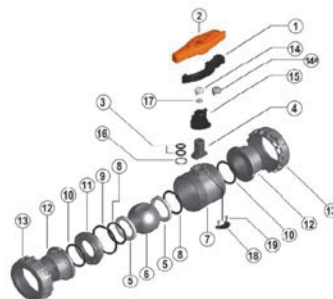

VXE

Válvula de bola VX Easyfit DN65+100.

| d | DN | Ref. EPDM | € | Ref. FKM | € |
|-----|-----|------------|-------|------------|--------|
| 75 | 65 | SETVXE075E | 63,36 | SETVXE075F | 214,48 |
| 90 | 80 | SETVXE090E | 79,18 | SETVXE090F | 274,45 |
| 110 | 100 | SETVXE110E | 94,73 | SETVXE110F | 331,66 |

| d | DN | Ref. | € |
|-----|-----|----------|-------|
| 75 | 65 | HSVXE075 | 57,02 |
| 90 | 80 | HSVXE090 | 57,65 |
| 110 | 100 | HSVXE110 | 75,04 |

Juego de juntas y asientos VXE.
 Posiciones 3-5-8-9-10-16.

Set maneta VXE. Maneta y tapón
 Posiciones 1-2.

| d | DN | Ref. PVC-U | € |
|-----|-----|------------|--------|
| 75 | 65 | NTVXE075V | 80,56 |
| 90 | 80 | NTVXE090V | 103,10 |
| 110 | 100 | NTVXE110V | 156,37 |

| Ref. C-PVC | € |
|------------|--------|
| NTVXE075C | 88,68 |
| NTVXE090C | 115,33 |
| NTVXE110C | 163,01 |

Tuercas VXE. Posición 13.



VEE

Válvula de bola VE Easyfit DN15+50.

| d | DN | Ref. EPDM | € |
|-------|-------|-----------|-------|
| 16-20 | 10-15 | SETVE020E | 4,78 |
| 25 | 20 | SETVE025E | 5,81 |
| 32 | 25 | SETVE032E | 8,16 |
| 40 | 32 | SETVE040E | 11,78 |
| 50 | 40 | SETVE050E | 17,64 |
| 63 | 50 | SETVE063E | 21,36 |

Juego de juntas y asientos VEE.
 Posiciones 2-6-9-10.

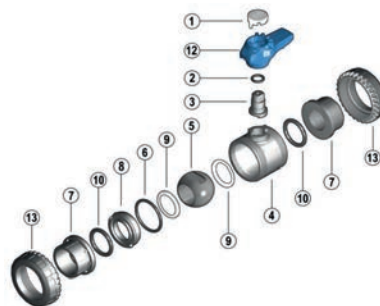

| d | DN | Ref. | € |
|-------|-------|----------|-------|
| 16-20 | 10-15 | HSVEE020 | 10,62 |
| 25 | 20 | HSVEE025 | 12,58 |
| 32 | 25 | HSVEE032 | 15,82 |
| 40 | 32 | HSVEE040 | 20,87 |
| 50 | 40 | HSVEE050 | 25,25 |
| 63 | 50 | HSVEE063 | 33,54 |

Maneta VEE.
 Posiciones 1-12.

Set maneta VEE
 compuesto por maneta y tapón



VEE

Válvula de bola VE Easyfit DN65+100.

| d | DN | Ref. EPDM | € |
|-----|-----|------------|-------|
| 75 | 75 | SETVEE075E | 22,71 |
| 90 | 90 | SETVEE090E | 28,10 |
| 110 | 110 | SETVEE110E | 35,68 |

Juego de juntas y asientos VEE.
 Posiciones 3-5-8-9-10-16.

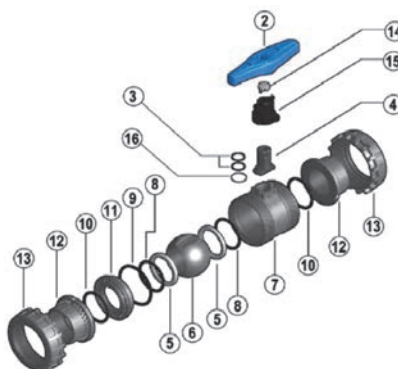

| d | DN | Ref. | € |
|-----|-----|----------|-------|
| 75 | 75 | HAVEE075 | 42,50 |
| 90 | 90 | HAVEE090 | 47,62 |
| 110 | 110 | HAVEE110 | 54,27 |

Maneta VEE.
 Posición 2.

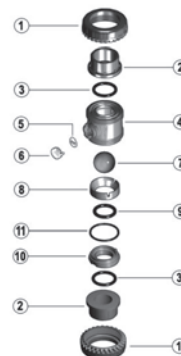

SXE

Válvula anti retorno de bola SX Easyfit DN10+50.

| d | DN | Ref. EPDM | € | Ref. FKM | € |
|-------|-------|------------|-------|------------|--------|
| 16-20 | 10-15 | SETSXE020E | 6,63 | SETSXE020F | 20,31 |
| 25 | 20 | SETSXE025E | 9,72 | SETSXE025F | 29,60 |
| 32 | 25 | SETSXE032E | 11,60 | SETSXE032F | 32,69 |
| 40 | 32 | SETSXE040E | 12,07 | SETSXE040F | 47,91 |
| 50 | 40 | SETSXE050E | 14,47 | SETSXE050F | 47,91 |
| 63 | 50 | SETSXE063E | 27,49 | SETSXE063F | 104,56 |

Juego de juntas y asientos SXE. Posiciones 3-9-11.

| d | DN | Ref. PVC-U | € |
|-------|-------|------------|-------|
| 16-20 | 10-15 | BLSR020V | 24,13 |
| 25 | 20 | BLSR025V | 24,13 |
| 32 | 25 | BLSR032V | 29,51 |
| 40 | 32 | BLSR040V | 48,27 |
| 50 | 40 | BLSR050V | 63,03 |
| 63 | 50 | BLSR063V | 87,85 |

Bola SXE. Posición 7.

| d | DN | Ref. PVC-U | € |
|-------|-------|------------|-------|
| 16-20 | 10-15 | SESXE020V | 4,84 |
| 25 | 20 | SESXE025V | 6,46 |
| 32 | 25 | SESXE032V | 5,24 |
| 40 | 32 | SESXE040V | 9,01 |
| 50 | 40 | SESXE050V | 7,92 |
| 63 | 50 | SESXE063V | 18,66 |

Casquillo SXE. Posición 10.

| d | DN | Ref. PVC-U | € |
|-------|-------|------------|-------|
| 16-20 | 10-15 | PRSXE020V | 6,47 |
| 25 | 20 | PRSXE025V | 7,97 |
| 32 | 25 | PRSXE032V | 10,80 |
| 40 | 32 | PRSXE040V | 11,89 |
| 50 | 40 | PRSXE050V | 14,52 |
| 63 | 50 | PRSXE063V | 17,22 |

Anillo de sujeción SXE. Posición 8

| d | DN | Ref. | € | d | DN | Ref. PVC-U | € |
|----|----|--------|-------|-------|-------|------------|-------|
| 32 | 25 | LCE020 | 29,61 | 16-20 | 10-15 | NTVXE020V | 9,74 |
| 40 | 32 | LCE025 | 29,73 | 25 | 20 | NTVXE025V | 10,96 |
| 50 | 40 | LCE032 | 31,65 | 32 | 25 | NTVXE032V | 13,15 |
| 63 | 50 | LCE032 | 31,65 | 40 | 32 | NTVXE040V | 17,29 |
| | | | | 50 | 40 | NTVXE050V | 21,34 |
| | | | | 63 | 50 | NTVXE063V | 27,81 |

Set LCE. Set tapón transparente + disco en PVC blanco (10 piezas de cada por set)
 Posiciones 5-6.

Tuerca SXE. Posición 1.

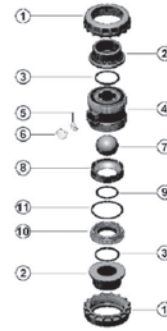

SXE

Válvula anti retorno de bola SX Easyfit DN65+100.

| d | DN | Ref. EPDM | € | Ref. FKM | € |
|-----|-----|-------------------|--------------|-------------------|---------------|
| 75 | 65 | SETSXE075E | 52,66 | SETSXE075F | 166,22 |
| 90 | 80 | SETSXE090E | 66,05 | SETSXE090F | 207,35 |
| 110 | 100 | SETSXE110E | 86,71 | SETSXE110F | 282,12 |

Juego de juntas y asientos SXE.

Posiciones 3-9-11.

| d | DN | Ref. PVC-U | € |
|-----|-----|------------------|---------------|
| 75 | 65 | BLSXE075V | 174,51 |
| 90 | 80 | BLSXE090V | 218,91 |
| 110 | 100 | BLSXE110V | 287,27 |

Bola SXE.

Posición 7.

| d | DN | Ref. PVC-U | € |
|-----|-----|------------------|--------------|
| 75 | 65 | SESXE075V | 33,15 |
| 90 | 80 | SESXE090V | 41,58 |
| 110 | 100 | SESXE110V | 54,56 |

Casquillo SXE.

Posición 10.

| d | DN | Ref. PVC-U | € |
|-----|-----|------------------|--------------|
| 75 | 65 | PRSXE075V | 46,08 |
| 90 | 80 | PRSXE090V | 57,78 |
| 110 | 100 | PRSXE110V | 75,85 |

Anillo de sujección SXE.

Posición 8

| d | DN | Ref. | € |
|-----|-----|---------------|--------------|
| 75 | 65 | LCE063 | 43,59 |
| 90 | 80 | LCE063 | 43,59 |
| 110 | 100 | LCE063 | 43,59 |

Set LCE. Set tapón transparente + disco en PVC blanco (10 piezas de cada por set)
 Posiciones 5-6.

| d | DN | Ref. PVC-U | € | Ref. C-PVC | € |
|-----|-----|------------------|---------------|------------------|---------------|
| 75 | 65 | NTVXE075V | 80,56 | NTVXE075C | 88,68 |
| 90 | 80 | NTVXE090V | 103,10 | NTVXE090C | 115,33 |
| 110 | 100 | NTVXE110V | 156,37 | NTVXE110C | 163,01 |

Tuerca SXE.

Posición 1.

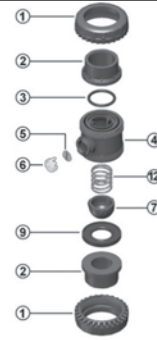

SSE

Válvula anti retorno con muelle SS Easyfit DN10+50.

| d | DN | Ref. EPDM | € | Ref. FKM | € |
|-------|-------|-------------|-------|-------------|-------|
| 16-20 | 10-15 | SETSSSE020E | 5,84 | SETSSSE020F | 17,14 |
| 25 | 20 | SETSSSE025E | 8,53 | SETSSSE025F | 24,96 |
| 32 | 25 | SETSSSE032E | 10,20 | SETSSSE032F | 27,57 |
| 40 | 32 | SETSSSE040E | 10,59 | SETSSSE040F | 40,41 |
| 50 | 40 | SETSSSE050E | 12,70 | SETSSSE050F | 40,41 |
| 63 | 50 | SETSSSE063E | 24,06 | SETSSSE063F | 88,11 |

Juego de juntas SSE.
 Posiciones 3-9.

| d | DN | Ref. PVC-U | € | Ref. C-PVC | € |
|-------|-------|------------|-------|------------|-------|
| 16-20 | 10-15 | NTVXE020V | 9,74 | NTVXE020C | 16,19 |
| 25 | 20 | NTVXE025V | 10,96 | NTVXE025C | 31,03 |
| 32 | 25 | NTVXE032V | 13,15 | NTVXE032C | 36,66 |
| 40 | 32 | NTVXE040V | 17,29 | NTVXE040C | 39,90 |
| 50 | 40 | NTVXE050V | 21,34 | NTVXE050C | 47,70 |
| 63 | 50 | NTVXE063V | 27,81 | NTVXE063C | 72,07 |

Tuerca SSE.
 Posición 1.

| d | DN | Ref. muelle INOX A316 | € | Ref. muelle INOX recubierto PTFE | € | Ref. muelle Hastelloy | € |
|-------|-------|--------------------------|-------|-------------------------------------|--------|--------------------------|-------|
| 16-20 | 10-15 | ASSE020VX | 23,32 | | | ASSE020VH | 69,48 |
| 25 | 20 | ASSE025VX | 23,32 | | | ASSE025VH | 65,34 |
| 32 | 25 | ASSE032VX | 28,47 | | | ASSE032VH | 74,03 |
| 40 | 32 | ASSE040VX | 46,64 | ASSE040V0P | 65,84 | | |
| 50 | 40 | ASSE050VX | 60,90 | ASSE050V0P | 82,35 | | |
| 63 | 50 | ASSE063VX | 84,91 | ASSE063V0P | 112,91 | | |

Tapón + muelle SSE.
 Posiciones 7-12.

| d | DN | Ref. | € |
|-------|-------|--------|-------|
| 32 | 25 | LCE020 | 29,61 |
| 40 | 32 | LCE025 | 29,73 |
| 50-63 | 40-50 | LCE032 | 31,65 |

Tuerca SSE.
 Posición 1.

Set tapón transparente + disco en PVC
 blanco (10 piezas de cada por set)

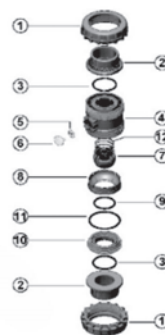

SSE

Válvula anti retorno con muelle SS Easyfit DN65+100.

| d | DN | Ref. EPDM | € | Ref. FKM | € | d | DN | Ref. | € |
|-----|-----|-------------------|--------------|-------------------|---------------|-----|-----|---------------|--------------|
| 75 | 65 | SETSXE075E | 52,66 | SETSXE075F | 166,22 | 75 | 65 | LCE063 | 43,59 |
| 90 | 80 | SETSXE090E | 66,05 | SETSXE090F | 207,35 | 90 | 80 | LCE063 | 43,59 |
| 110 | 100 | SETSXE110E | 86,71 | SETSXE110F | 282,12 | 110 | 100 | LCE063 | 43,59 |

Juego de juntas SSE.
 Posiciones 3-9-11.

Set LCE. Set tapón transparente + disco en PVC blanco (10 piezas de cada por set)
 Posiciones 5-6.

| d | DN | Ref. muelle INOX A316 | € | Ref. muelle INOX recubierto PTFE | € |
|-----|-----|-----------------------|---------------|----------------------------------|---------------|
| 75 | 65 | ASSE075VX | 168,60 | ASSE075VOP | 209,09 |
| 90 | 80 | ASSE090VX | 211,54 | ASSE090VOP | 260,37 |
| 110 | 100 | ASSE110VX | 277,54 | ASSE110VOP | 328,47 |

Tapón + muelle SSE.
 Posiciones 7-12.

| d | DN | Ref. PVC-U | € | Ref. C-PVC | € |
|-----|-----|------------------|--------------|------------------|---------------|
| 75 | 65 | SESXE075V | 33,15 | SESXE075C | 95,81 |
| 90 | 80 | SESXE090V | 41,58 | SESXE090C | 124,52 |
| 110 | 100 | SESXE110V | 54,56 | SESXE110C | 233,78 |

Casquillo SSE.
 Posición 10.

| d | DN | Ref. PVC-U | € | Ref. C-PVC | € |
|-----|-----|------------------|--------------|------------------|---------------|
| 75 | 65 | PRSXE075V | 46,08 | PRSXE075C | 138,36 |
| 90 | 80 | PRSXE090V | 57,78 | PRSXE090C | 178,72 |
| 110 | 100 | PRSXE110V | 75,85 | PRSXE110C | 335,56 |

Anillo sujeción SSE.
 Posición 8.

| d | DN | Ref. PVC-U | € | Ref. C-PVC | € |
|-----|-----|------------------|---------------|------------------|---------------|
| 75 | 65 | NTVXE075V | 80,56 | NTVXE075C | 88,68 |
| 90 | 80 | NTVXE090V | 103,10 | NTVXE090C | 115,33 |
| 110 | 100 | NTVXE110V | 156,37 | NTVXE110C | 163,01 |

Tuerca SSE.
 Posición 1.

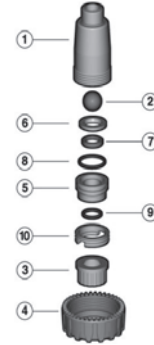

SR

Válvula anti-retorno de bola DN15+50.

| d | DN | Ref. EPDM | € | Ref. FKM | € |
|----|----|-----------|-------|-----------|-------|
| 20 | 15 | SETSR020E | 7,13 | SETSR020F | 21,66 |
| 25 | 20 | SETSR025E | 7,13 | SETSR025F | 21,66 |
| 32 | 25 | SETSR032E | 8,09 | SETSR032F | 22,79 |
| 40 | 32 | SETSR040E | 9,40 | SETSR040F | 37,35 |
| 50 | 40 | SETSR050E | 16,26 | SETSR050F | 53,78 |
| 63 | 50 | SETSR063E | 20,31 | SETSR063F | 77,30 |

Juego de juntas SR. Posiciones 7-8-9.

| d | DN | Ref. PPH | € | Ref. PVDF | € |
|----|----|----------|--------|-----------|--------|
| 20 | 15 | BLSR020M | 33,79 | BLSR020F | 48,45 |
| 25 | 20 | BLSR025M | 33,79 | BLSR025F | 55,56 |
| 32 | 25 | BLSR032M | 41,26 | BLSR032F | 132,49 |
| 40 | 32 | BLSR040M | 67,60 | BLSR040F | 171,37 |
| 50 | 40 | BLSR050M | 88,28 | BLSR050F | 302,60 |
| 63 | 50 | BLSR063M | 122,95 | BLSR063F | 461,13 |

Bola SR. Posición 2.

| d | DN | Ref. PPH | € | Ref. PVDF | € |
|----|----|----------|--------|-----------|--------|
| 20 | 15 | SESR020M | 42,22 | SESR020F | 98,68 |
| 25 | 20 | SESR025M | 63,79 | SESR025F | 137,52 |
| 32 | 25 | SESR032M | 63,79 | SESR032F | 149,49 |
| 40 | 32 | SESR040M | 80,52 | SESR040F | 245,72 |
| 50 | 40 | SESR050M | 80,52 | SESR050F | 245,72 |
| 63 | 50 | SESR063M | 106,46 | SESR063F | 354,17 |

Casquillo SR. Posiciones 5-10.

| d | DN | Ref. PPH | € | Ref. PVDF | € |
|----|----|----------|-------|-----------|--------|
| 20 | 15 | PRSR020M | 8,61 | PRSR020F | 28,03 |
| 25 | 20 | PRSR025M | 20,47 | PRSR025F | 34,97 |
| 32 | 25 | PRSR032M | 20,97 | PRSR032F | 46,20 |
| 40 | 32 | PRSR040M | 21,55 | PRSR040F | 79,73 |
| 50 | 40 | PRSR050M | 23,72 | PRSR050F | 99,38 |
| 63 | 50 | PRSR063M | 29,08 | PRSR063F | 127,38 |

Anillo sujeción SR. Posición 6.

| d | DN | Ref. PPH | € | Ref. PVDF | € |
|----|----|-----------|-------|-----------|--------|
| 20 | 15 | NTVKD020M | 13,61 | NTVKD020F | 74,03 |
| 25 | 20 | NTVKD025M | 25,99 | NTVKD025F | 78,20 |
| 32 | 25 | NTVKD032M | 31,32 | NTVKD032F | 101,47 |
| 40 | 32 | NTVKD040M | 34,14 | NTVKD040F | 137,41 |
| 50 | 40 | NTVKD050M | 40,22 | NTVKD050F | 160,63 |
| 63 | 50 | NTVKD063M | 61,48 | NTVKD063F | 249,87 |

Tuerca SR. Posición 4..

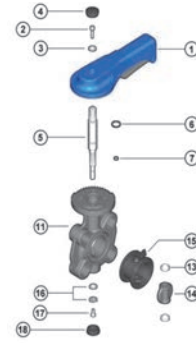

FE

Válvula de mariposa FE DN40+50.

| d | DN | Ref. EPDM | € | Ref. FKM | € |
|-------|-------|------------------|-------------|------------------|--------------|
| 50-63 | 40-50 | SETFK063E | 8,80 | SETFK063F | 20,47 |

Juego de juntas FE.
 Posiciones 6-7-13.

| d | DN | Ref. | € |
|-------|-------|-----------------|--------------|
| 50-63 | 40-50 | HSFE0S11 | 44,90 |

Maneta FE. Con tornillo y tapón de protección.
 Posiciones 1-2-3-4.

| d | DN | Ref. EPDM | € | Ref. FKM | € |
|----|----|----------------|--------------|----------------|---------------|
| 50 | 40 | LIN050E | 31,83 | LIN050F | 190,10 |
| 63 | 50 | LIN063E | 33,60 | LIN063F | 200,66 |

Juego primaria FE.
 Posición 15

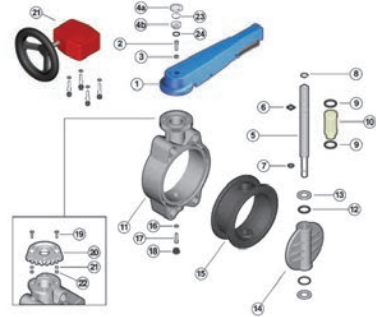

FE

Válvula de mariposa FE DN65+200.

| d | DN | Ref. EPDM | € | Ref. FKM | € | d | DN | Ref. | € |
|-----|-----|-----------|-------|-----------|-------|-----|-----|---------|--------|
| 75 | 65 | SETFK075E | 9,74 | SETFK075F | 22,79 | 75 | 65 | STFE075 | 80,20 |
| 90 | 80 | SETFK090E | 9,98 | SETFK090F | 22,79 | 90 | 80 | STFE090 | 90,25 |
| 110 | 100 | SETFK110E | 10,38 | SETFK110F | 22,79 | 110 | 100 | STFE110 | 100,25 |
| 140 | 125 | SETFK140E | 11,38 | SETFK140F | 24,30 | 140 | 125 | STFE140 | 120,27 |
| 160 | 150 | SETFK160E | 16,40 | SETFK160F | 30,43 | 160 | 150 | STFE160 | 140,35 |
| 225 | 200 | SETFK225E | 26,39 | SETFK225F | 47,14 | 225 | 200 | STFE225 | 240,59 |

Juego de juntas FE.
 Posiciones 6-7-9-12-13.

Eje FE.
 Posición 5.

| d | DN | Ref. EPDM | € | Ref. FKM | € | Ref. NBR | € |
|-----|-----|-----------|--------|----------|----------|----------|--------|
| 75 | 65 | LIN075E | 35,41 | LIN075F | 296,16 | LIN075N | 38,90 |
| 90 | 80 | LIN090E | 38,99 | LIN090F | 351,88 | LIN090N | 42,94 |
| 110 | 100 | LIN110E | 47,53 | LIN110F | 507,44 | LIN110N | 52,26 |
| 140 | 125 | LIN140E | 64,50 | LIN140F | 735,69 | LIN140N | 70,99 |
| 160 | 150 | LIN160E | 71,52 | LIN160F | 921,85 | LIN160N | 78,65 |
| 225 | 200 | LIN225E | 126,03 | LIN225F | 1.533,19 | LIN225N | 138,68 |

Junta primaria FE.
 Posición 15.

| d | DN | Ref. PVC-U | € | d | DN | Ref. | € | d | DN | Ref. | € |
|-----|-----|------------|--------|-----|-----|----------|-------|-----|-----|--------|--------|
| 75 | 65 | DISCV075 | 62,25 | 75 | 65 | HSFE0S11 | 44,90 | 75 | 65 | GEAR01 | 409,67 |
| 90 | 80 | DISCV090 | 73,23 | 90 | 80 | HSFE0M14 | 50,08 | 90 | 80 | GEAR01 | 409,67 |
| 110 | 100 | DISCV110 | 95,40 | 110 | 100 | HSFE0M14 | 50,08 | 110 | 100 | GEAR01 | 409,67 |
| 140 | 125 | DISCV140 | 125,16 | 140 | 125 | HSFE0L17 | 55,43 | 140 | 125 | GEAR02 | 409,67 |
| 160 | 150 | DISCV160 | 160,15 | 160 | 150 | HSFE0L17 | 55,43 | 160 | 150 | GEAR02 | 409,67 |
| 225 | 200 | DISCV225 | 221,84 | 225 | 200 | HSFEXL22 | 98,54 | 225 | 200 | GEAR03 | 501,16 |

Disco FE.
 Posición 14.

Maneta FE.
 Posiciones 1-2-3-4.

Con tornillo y tapón de
 protección

Kit volante FE.
 Posición 29.

Con tornillos y brida si es
 necesaria

| d | DN | Ref. | € |
|-----|-----|---------|-------|
| 225 | 200 | UFFE225 | 54,67 |

Brida superior con trinquete FE.
 Posiciones 19-20-21-22.

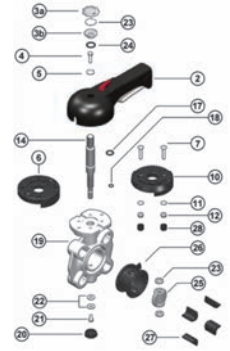

FK

Válvula de mariposa FK DN40+50.

| d | DN | Ref. EPDM | € | Ref. FKM | € |
|-------|-------|------------------|-------------|------------------|--------------|
| 50-63 | 40-50 | SETFK063E | 8,80 | SETFK063F | 20,47 |

Juego de juntas FK.
 Posiciones 17-18-23.

| d | DN | Ref. | € |
|-------|-------|------------------|--------------|
| 50-63 | 40-50 | HSFKD0S11 | 58,29 |

Maneta FK. Con tornillo y tapón de protección
 Posiciones 2-3a-3b-4-5.

| d | DN | Ref. EPDM | € | Ref. FKM | € |
|----|----|----------------|--------------|----------------|---------------|
| 50 | 40 | LIN050E | 31,83 | LIN050F | 190,10 |
| 63 | 50 | LIN063E | 33,60 | LIN063F | 200,66 |

Juego primaria FK
 Posición 26.

| d | DN | Ref. PVC-U | € | Ref. PP-H | € | Ref. PVDF | € | Ref. C-PVC | € |
|----|----|-----------------|--------------|-----------------|--------------|-----------------|---------------|-----------------|--------------|
| 50 | 40 | DISCV050 | 52,95 | DISCM050 | 64,62 | DISCF050 | 184,76 | DISCC050 | 77,49 |
| 63 | 50 | DISCV063 | 56,04 | DISCM063 | 68,43 | DISCF063 | 195,62 | DISCC063 | 82,08 |

Disco FK.
 Posición 25.

| d | DN | Ref. | € |
|-------|-------|----------------|--------------|
| 50-63 | 40-50 | UFFK160 | 30,19 |

Brida superior FK.
 Posiciones 7-10-11-12-28.

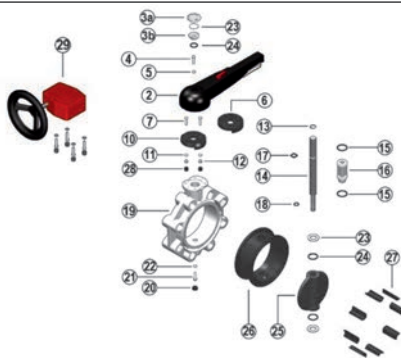

FK

Válvula de mariposa FK DN65+200.

| d | DN | Ref. EPDM | € | Ref. FKM | € |
|-----|-----|-----------|-------|-----------|-------|
| 75 | 65 | SETFK075E | 9,74 | SETFK075F | 22,79 |
| 90 | 80 | SETFK090E | 9,98 | SETFK090F | 22,79 |
| 110 | 100 | SETFK110E | 10,38 | SETFK110F | 22,79 |
| 140 | 125 | SETFK140E | 11,38 | SETFK140F | 24,30 |
| 160 | 150 | SETFK160E | 16,40 | SETFK160F | 30,43 |
| 225 | 200 | SETFK225E | 26,39 | SETFK225F | 47,14 |

Juego de juntas FK. Posiciones 15-17-18-23-24.

| d | DN | Ref. PVC-U | € | Ref. PP-H | € | Ref. PVDF | € | Ref. C-PVC | € |
|-----|-----|------------|--------|-----------|--------|-----------|--------|------------|--------|
| 75 | 65 | DISCV075 | 62,25 | DISCM075 | 76,07 | DISCF075 | 217,33 | DISCC075 | 91,14 |
| 90 | 80 | DISCV090 | 73,23 | DISCM090 | 88,19 | DISCF090 | 228,98 | DISCC090 | 106,41 |
| 110 | 100 | DISCV110 | 95,40 | DISCM110 | 104,79 | DISCF110 | 244,92 | DISCC110 | 118,53 |
| 140 | 125 | DISCV140 | 125,16 | DISCM140 | 137,68 | DISCF140 | 319,88 | DISCC140 | 144,12 |
| 160 | 150 | DISCV160 | 160,15 | DISCM160 | 161,05 | DISCF160 | 343,63 | DISCC160 | 169,56 |
| 225 | 200 | DISCV225 | 221,84 | DISCM225 | 244,33 | DISCF225 | 434,56 | DISCC225 | 255,57 |

Disco FK. Posición 25.

| d | DN | Ref. | € |
|---------|---------|--------|--------|
| 75-110 | 65-100 | GEAR01 | 409,67 |
| 140-160 | 125-150 | GEAR02 | 409,67 |
| 225 | 200 | GEAR03 | 501,16 |

Kit volante FK. Posición 29.

Con tornillos y brida si es necesaria

| d | DN | Ref. | € |
|--------|--------|---------|-------|
| 75-160 | 65-150 | UFFK160 | 30,19 |
| 225 | 200 | UFFK225 | 45,90 |

Brida superior con trinquete FK.

Posición 7-10-11-12-28.

| d | DN | Ref. EPDM | € | Ref. FKM | € | Ref. NBR | € |
|-----|-----|-----------|--------|----------|----------|----------|--------|
| 75 | 65 | LIN075E | 35,41 | LIN075F | 296,16 | LIN075N | 38,90 |
| 90 | 80 | LIN090E | 38,99 | LIN090F | 351,88 | LIN090N | 42,94 |
| 110 | 100 | LIN110E | 47,53 | LIN110F | 507,44 | LIN110N | 52,26 |
| 140 | 125 | LIN140E | 64,50 | LIN140F | 735,69 | LIN140N | 70,99 |
| 160 | 150 | LIN160E | 71,52 | LIN160F | 921,85 | LIN160N | 78,65 |
| 225 | 200 | LIN225E | 126,03 | LIN225F | 1.533,19 | LIN225N | 138,68 |

Junta primaria FK. Posición 26.

| d | DN | Ref. | € |
|---------|---------|-----------|--------|
| 75 | 65 | HSFKD0S11 | 58,29 |
| 90-110 | 80-100 | HSFKD0M14 | 76,96 |
| 140-160 | 125-150 | HSFKD0L17 | 85,10 |
| 225 | 200 | HSFKDXL22 | 125,56 |

Maneta FK.

Posición 2-3a-3b-4-5.

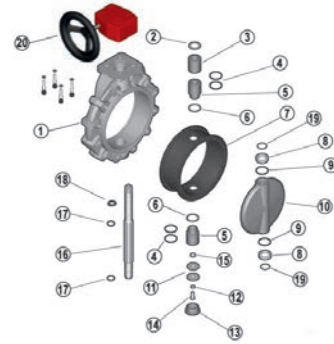

FK

Válvula de mariposa FK DN200-300.

| d | DN | Ref. EPDM | € | Ref. FKM | € |
|-----|-----|-----------|-------|-----------|--------|
| 280 | 250 | SETFK315E | 83,80 | SETFK315F | 150,01 |
| 315 | 300 | SETFK315E | 83,80 | SETFK315F | 150,01 |

Juego de juntas FK. Posiciones 15-17-18-23-24.

| d | DN | Ref. EPDM | € | Ref. FKM | € |
|-----|-----|-----------|--------|----------|----------|
| 280 | 250 | LIN280E | 267,58 | LIN280F | 1.750,53 |
| 315 | 300 | LIN315E | 374,53 | LIN315F | 2.145,68 |

Junta primaria FK. Posición 7.

| d | DN | Ref. PVC-U | € | Ref. PP-H | € | Ref. PVDF | € | Ref. C-PVC | € |
|-----|-----|------------|--------|-----------|--------|-----------|--------|------------|--------|
| 280 | 250 | DISCV280 | 428,87 | DISCM280 | 485,18 | DISCF280 | 780,27 | DISCC280 | 515,13 |
| 315 | 300 | DISCV315 | 467,65 | DISCM315 | 530,79 | DISCF315 | 851,76 | DISCC315 | 561,43 |

Disco FK. Posición 10.

| d | DN | Ref. | € |
|---------|---------|--------|--------|
| 280-315 | 250-300 | GEAR04 | 585,28 |

Kit volante FK. Posición 20. Con tornillos y brida si es necesaria

| d | DN | Ref. | € |
|-----|-----|-------------|--------|
| 280 | 250 | STFK280 (*) | 521,24 |
| 315 | 300 | STFK315 (*) | 601,42 |

Eje FK. Posición 16.

(*) Para válvulas con el disco en PVDF usar los códigos STFK280F y STFL315F



FK

Válvula de mariposa FK DN355-400.

| d | DN | Ref. EPDM | € | Ref. FKM | € |
|---------|---------|-----------|-------|-----------|--------|
| 355-400 | 350-400 | SETFK400E | 70,99 | SETFK400F | 134,93 |

Juego de juntas FK. Posición 4-6-9-17.

| d | DN | Ref. EPDM | € | Ref. FKM | € |
|-----|-----|-----------|--------|----------|----------|
| 355 | 350 | LIN355E | 561,25 | LIN355F | 4.099,53 |
| 400 | 400 | LIN400E | 652,02 | LIN400F | 5.760,47 |

Junta primaria FK. Posición 7.

| d | DN | Ref. PVC-U | € | Ref. PP-H | € | Ref. PVDF | € |
|-----|-----|------------|--------|-----------|----------|-----------|----------|
| 355 | 350 | DISCV355 | 825,32 | DISCM355 | 924,36 | DISCF355 | 4.447,14 |
| 400 | 400 | DISCV400 | 924,36 | DISCM400 | 1.072,92 | DISCF400 | 5.407,55 |

Disco FK. Posición 10.

| d | DN | Ref. | € |
|---------|---------|--------|----------|
| 355-400 | 350-400 | GEAR05 | 1.019,04 |

Volante FK. Posición 20.

| d | DN | Ref. | € |
|-----|-----|-------------|--------|
| 355 | 350 | STFK355 (*) | 724,22 |
| 400 | 400 | STFK400 (*) | 812,55 |

Eje FK. Posición 16.

(*) Sólo para válvulas con el disco en PVDF-U. Para otros materiales consultar

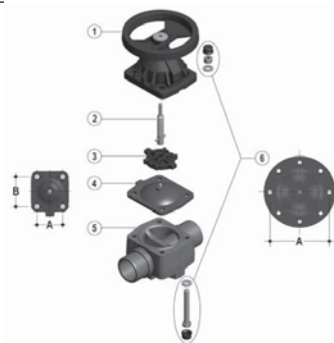

VM

Válvula de membrana VM.

| d | DN | Ref. EPDM | € | Ref. FKM | € | Ref. PTFE | € | Ref. NBR | € |
|-----|-----|-----------|--------|----------|----------|-----------|--------|----------|--------|
| 90 | 80 | DIA090E | 145,52 | DIA090F | 701,04 | DIA090P | 632,20 | DIA090N | 145,52 |
| 110 | 100 | DIA110E | 294,19 | DIA110F | 1.333,24 | DIA110P | 932,60 | DIA110N | 294,19 |

Membrana VM. Posición 4.

| d | DN | Ref. PVC-U (EPDM / FKM) | € | Ref. PP-H (EPDM / FKM) | € | Ref. PVDF (EPDM / FKM) | € | Ref. C-PVC (EPDM / FKM) | € |
|-----|-----|----------------------------|--------|---------------------------|--------|---------------------------|----------|----------------------------|--------|
| 90 | 80 | SPBDVM090DV | 266,11 | SPBDVM090DM | 332,64 | SPBDVM090DF | 1.585,62 | SPBDVM090DC | 521,10 |
| 110 | 100 | SPBDVM110DV | 354,79 | SPBDVM110DM | 376,98 | SPBDVM110DF | 2.306,27 | SPBDVM110DC | 671,90 |

| d | DN | Ref. PVC-U (PTFE) | € | Ref. PP-H (PTFE) | € | Ref. PVDF (PTFE) | € | Ref. C-PVC (PTFE) | € |
|-----|-----|----------------------|--------|---------------------|--------|---------------------|----------|----------------------|--------|
| 90 | 80 | SPBDVMP090DV | 294,95 | SPBDVMP090DM | 365,89 | SPBDVMP090DF | 1.628,77 | SPBDVMP090DC | 549,94 |
| 110 | 100 | SPBDVMP110DV | 388,09 | SPBDVMP110DM | 410,26 | SPBDVMP110DF | 2.349,48 | SPBDVMP110DC | 700,74 |

Cuerpo M-M VMD... Posición 5.

| d | DN | Ref. | € |
|-----|-----|--------------|--------|
| 90 | 80 | COVMMN075090 | 144,15 |
| 110 | 100 | COVMMN110 | 155,24 |

Compresor VM. Posición 3.

| d | DN | Ref. | € |
|-----|-----|--------------|--------|
| 90 | 80 | ATVMMN075090 | 609,84 |
| 110 | 100 | ATVMMN110 | 820,52 |

Volante DK. Posiciones 1-2-6.

| d | DN | Ref. | € |
|-----|-----|--------------|--------|
| 90 | 80 | BSVMMN75090X | 126,37 |
| 110 | 100 | BSVMMN110X | 188,99 |

Cierres VM. Posiciones 10-11-12.

Kit cierre DK compuesto por tornillos, tuercas y tapones protectores

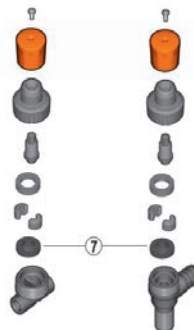

VM-RM

Grifo de membrana VM-RM.

| d - Rh | DN | Ref. | € |
|-----------|----|-----------|-------|
| 12 - 1/4" | 8 | DIARM020E | 12,09 |
| 20 - 1/2" | 15 | DIARM020E | 12,09 |

Cierres VM. Posiciones 10-11-12.

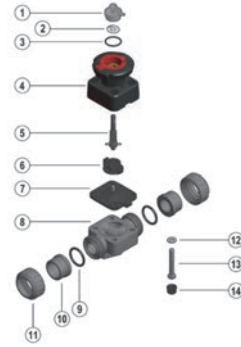

DK

Válvula de membrana DK.

| d | DN | Ref. EPDM | € | Ref. FKM | € | Ref. PTFE | € | Ref. NBR | € |
|----|----|-----------|-------|----------|--------|-----------|--------|----------|-------|
| 20 | 15 | DIA025E | 32,93 | DIA025F | 107,36 | DIADK025P | 127,59 | DIA025N | 32,93 |
| 25 | 20 | DIA025E | 32,93 | DIA025F | 107,36 | DIADK025P | 127,59 | DIA025N | 32,93 |
| 32 | 25 | DIA032E | 34,38 | DIA032F | 118,87 | DIADK032P | 145,52 | DIA032N | 34,38 |
| 40 | 32 | DIA032E | 34,38 | DIA032F | 118,87 | DIADK032P | 145,52 | DIA032N | 34,38 |
| 50 | 40 | DIA050E | 42,23 | DIA050F | 201,85 | DIADK050P | 240,99 | DIA050N | 42,23 |
| 63 | 50 | DIA063E | 62,61 | DIA063F | 287,98 | DIADK063P | 295,66 | DIA063N | 62,61 |
| 75 | 65 | DIA063E | 62,61 | DIA063F | 287,98 | DIADK063P | 295,66 | DIA063N | 62,61 |

Membrana DK.

Posición 7.

| d | DN | Ref. PVC-U | € | Ref. PP-H | € | Ref. PVDF | € | Ref. C-PVC | € |
|----|----|-------------|--------|-------------|--------|-------------|--------|-------------|--------|
| 20 | 15 | SPBDDK020DV | 38,77 | SPBDDK020DM | 52,56 | SPBDDK020DF | 155,11 | SPBDDK020DC | 56,97 |
| 25 | 20 | SPBDDK025DV | 41,78 | SPBDDK025DM | 58,47 | SPBDDK025DF | 166,67 | SPBDDK025DC | 65,77 |
| 32 | 25 | SPBDDK032DV | 56,12 | SPBDDK032DM | 82,53 | SPBDDK032DF | 205,21 | SPBDDK032DC | 89,80 |
| 40 | 32 | SPBDDK040DV | 60,01 | SPBDDK040DM | 83,06 | SPBDDK040DF | 300,12 | SPBDDK040DC | 103,58 |
| 50 | 40 | SPBDDK050DV | 73,66 | SPBDDK050DM | 140,37 | SPBDDK050DF | 367,34 | SPBDDK050DC | 135,08 |
| 63 | 50 | SPBDDK063DV | 96,67 | SPBDDK063DM | 168,39 | SPBDDK063DF | 494,50 | SPBDDK063DC | 140,61 |
| 75 | 65 | SPBDDK075DV | 135,30 | SPBDDK075DM | 235,74 | SPBDDK075DF | 692,29 | SPBDDK075DC | 196,86 |

Cuerpo M-M DKD...

Posición 8.

Cuerpo DK con spigots para encolar macho serie métrica

| d | DN | Ref. PVC-U | € | Ref. PP-H | € | Ref. PVDF | € | Ref. C-PVC | € |
|----|----|------------|--------|------------|--------|------------|--------|------------|--------|
| 20 | 15 | UNBDDK020V | 41,15 | UNBDDK020M | 91,72 | UNBDDK020F | 164,51 | UNBDDK020C | 98,85 |
| 25 | 20 | UNBDDK025V | 45,96 | UNBDDK025M | 98,46 | UNBDDK025F | 183,42 | UNBDDK025C | 111,85 |
| 32 | 25 | UNBDDK032V | 62,30 | UNBDDK032M | 124,60 | UNBDDK032F | 227,78 | UNBDDK032C | 151,36 |
| 40 | 32 | UNBDDK040V | 69,40 | UNBDDK040M | 138,86 | UNBDDK040F | 335,68 | UNBDDK040C | 175,39 |
| 50 | 40 | UNBDDK050V | 93,07 | UNBDDK050M | 177,26 | UNBDDK050F | 385,96 | UNBDDK050C | 221,58 |
| 63 | 50 | UNBDDK063V | 118,92 | UNBDDK063M | 219,61 | UNBDDK063F | 522,79 | UNBDDK063C | 265,32 |

Cuerpo con enlace DKU...

Posición 8.

Cuerpo DK con enlaces para encolar hembra

Continúa en la página siguiente...

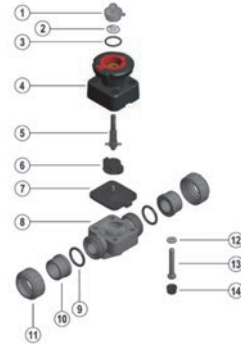

DK

Válvula de membrana DK.

| d | DN | Ref. PVC-U | € | Ref. PP-H | € | Ref. PVDF | € | Ref. C-PVC | € |
|----|----|-------------|--------|-------------|--------|-------------|--------|-------------|--------|
| 20 | 15 | FLBDDK020OV | 102,81 | FLBDDK020OM | 144,81 | FLBDDK020OF | 356,62 | FLBDDK020OC | 173,75 |
| 25 | 20 | FLBDDK025OV | 116,24 | FLBDDK025OM | 158,47 | FLBDDK025OF | 373,76 | FLBDDK025OC | 203,55 |
| 32 | 25 | FLBDDK032OV | 145,68 | FLBDDK032OM | 201,27 | FLBDDK032OF | 432,82 | FLBDDK032OC | 241,63 |
| 40 | 32 | FLBDDK040OV | 180,33 | FLBDDK040OM | 244,58 | FLBDDK040OF | 686,64 | FLBDDK040OC | 296,56 |
| 50 | 40 | FLBDDK050OV | 227,36 | FLBDDK050OM | 305,12 | FLBDDK050OF | 769,60 | FLBDDK050OC | 358,29 |
| 63 | 50 | FLBDDK063OV | 282,78 | FLBDDK063OM | 383,48 | FLBDDK063OF | 990,67 | FLBDDK063OV | 282,78 |

Cuerpo con bridas DKO...
 Posición 8.

Cuerpo DK con bridas PN10/16 FF EN 558-1
 Disponible también con bridas ANSI 150 lbs. al mismo precio

| d | DN | Ref. | € |
|---------|---------|--------------|-------|
| 20 ÷ 25 | 15 ÷ 20 | CODK020025 | 20,55 |
| 32 ÷ 40 | 25 ÷ 32 | CODK032040 | 22,47 |
| 50 | 40 | COVMMN040050 | 28,69 |
| 63 ÷ 75 | 50 ÷ 65 | COVMMN063 | 37,21 |

Compresor DK.
 Posición 6.

| d | DN | Ref. | € |
|---------|---------|--------------|--------|
| 20 ÷ 25 | 15 ÷ 20 | ATDKMN020025 | 78,52 |
| 32 ÷ 40 | 25 ÷ 32 | ATDKMN032040 | 113,08 |
| 50 | 40 | ATDKMN050 | 155,68 |
| 63 ÷ 75 | 50 ÷ 65 | ATDKMN063075 | 190,18 |

Volante DK.
 Posiciones 1-2-3-4-5-6.

| d | DN | Ref. | € |
|---------|---------|--------------|-------|
| 20 ÷ 40 | 15 ÷ 32 | TCSDKMN02004 | 22,42 |
| 50 | 40 | TCSDKMN050 | 28,39 |
| 63 ÷ 75 | 50 ÷ 65 | TCSDKMN06307 | 32,43 |

Tapón transparente DK.
 Posiciones 1-2-3.

| d | DN | Ref. | € |
|---------|---------|-------------|-------|
| 20 ÷ 25 | 15 ÷ 20 | BSDK020025X | 27,34 |
| 32 ÷ 40 | 25 ÷ 32 | BSVM020032X | 37,69 |
| 50 | 40 | BSVM040050X | 44,34 |
| 63 ÷ 75 | 50 ÷ 65 | BSVM063X | 55,54 |

Kit cierre DK.
 Posiciones 12-13-14.

Compuesto por tornillos,
 tuercas y tapones protectores

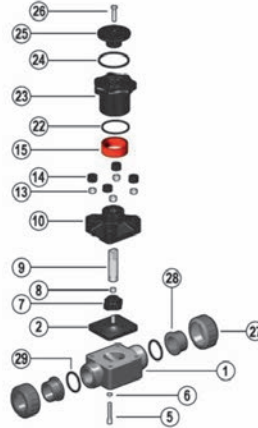

CM

Válvula de membrana compacta CM.

| d | DN | Ref. EPDM | € | Ref. FKM | € | Ref. PTFE | € |
|---------|---------|------------------|--------------|------------------|--------------|-------------------|--------------|
| 16 - 20 | 10 - 15 | DIACM020E | 28,18 | DIACM020F | 92,33 | DIACM020Q* | 84,51 |

Membrana CM.
 Posición 2.

* Para válvulas suministradas antes de enero 2019 por favor solicitar la membrana en PTFE con el código DIACM020P.

| d | DN | Ref. PVC-U (EPDM / FKM) | € | Ref. PP-H (EPDM / FKM) | € | Ref. PVDF (EPDM / FKM) | € | Ref. C-PVC (EPDM / FKM) | € |
|---------|---------|----------------------------|--------------|---------------------------|--------------|---------------------------|---------------|----------------------------|--------------|
| 16 - 20 | 10 - 15 | SPBDCM020DV | 28,31 | SSPBDCM020DM | 34,27 | SPBDCM020DF | 135,15 | SPBDCM020DC | 94,49 |

| d | DN | Ref. PVC-U (PTFE) | € | Ref. PP-H (PTFE) | € | Ref. PVDF (PTFE) | € | Ref. C-PVC (PTFE) | € |
|---------|---------|----------------------|--------------|---------------------|--------------|---------------------|---------------|----------------------|---------------|
| 16 - 20 | 10 - 15 | SPBDCMQ020DV | 42,85 | SPBDCMQ020DM | 51,40 | SPBDCMQ020DF | 144,83 | SPBDCMQ020DC | 102,85 |

Cuerpo M-M CMD...
 Posición 1.

Cuerpo CM con spigots para membranas EPDM / FKM o PTFE

| d | DN | Ref. PVC-U (EPDM / FKM) | € | Ref. PP-H (EPDM / FKM) | € | Ref. PVDF (EPDM / FKM) | € | Ref. C-PVC (EPDM / FKM) | € |
|---------|---------|----------------------------|--------------|---------------------------|--------------|---------------------------|---------------|----------------------------|---------------|
| 16 - 20 | 10 - 15 | UNBDCM020V | 56,68 | UNBDCM020M | 66,11 | UNBDCM020F | 171,96 | UNBDCM020C | 123,13 |

| d | DN | Ref. PVC-U (PTFE) | € | Ref. PP-H (PTFE) | € | Ref. PVDF (PTFE) | € | Ref. C-PVC (PTFE) | € |
|---------|---------|----------------------|--------------|---------------------|--------------|---------------------|---------------|----------------------|---------------|
| 16 - 20 | 10 - 15 | UNBDCMQ020V | 68,56 | UNBDCMQ020M | 77,17 | UNBDCMQ020F | 178,25 | UNBDCMQ020C | 128,78 |

Cuerpo con enlace CMU...
 Posición 1.

Cuerpo CM con enlaces para membranas EPDM / FKM o PTFE

Continúa en la página siguiente...

| d | DN | Ref. PVC-U (EPDM / FKM) | € | Ref. PP-H (EPDM / FKM) | € | Ref. PVDF (EPDM / FKM) | € |
|----|----|----------------------------|-------|---------------------------|-------|---------------------------|--------|
| 16 | 10 | SKBDCM016IV | 43,97 | SKBDCM016IM | 62,09 | SKBDCM016IF | 135,15 |
| 20 | 15 | SKBDCM020IV | 43,97 | SKBDCM020IM | 62,09 | SKBDCM020IF | 135,15 |

| d | DN | Ref. PVC-U (PTFE) | € | Ref. PP-H (PTFE) | € | Ref. PVDF (FKM) | € |
|----|----|----------------------|-------|---------------------|-------|--------------------|--------|
| 16 | 10 | SKBDCMQ016IV | 57,01 | SKBDCMQ016IM | 74,42 | SKBDCMQ016IF | 144,83 |
| 20 | 15 | SKBDCMQ020IV | 57,01 | SKBDCMQ020IM | 74,42 | SKBDCMQ020IF | 144,83 |

Cuerpo H-H CMI...
 Posición 1.

Cuerpo CM H-H para membranas EPDM / FKM o PTFE

| Rh | DN | Ref. PVC-U (EPDM / FKM) | € | Ref. PP-H (EPDM / FKM) | € | Ref. PVDF (EPDM / FKM) | € |
|------|----|----------------------------|-------|---------------------------|-------|---------------------------|--------|
| 3/8" | 10 | TRBDCM038FV | 43,97 | TRBDCM038FM | 62,09 | TRBDCM038FF | 135,15 |
| 1/2" | 15 | TRBDCM012FV | 43,97 | TRBDCM012FM | 62,09 | TRBDCM012FF | 135,15 |

| Rh | DN | Ref. PVC-U (PTFE) | € | Ref. PP-H (PTFE) | € | Ref. PVDF (FKM) | € |
|------|----|----------------------|-------|---------------------|-------|--------------------|--------|
| 3/8" | 10 | TRBDCMQ038FV | 57,01 | TRBDCMQ038FM | 74,42 | TRBDCMQ038FF | 144,83 |
| 1/2" | 15 | TRBDCMQ012FV | 57,01 | TRBDCMQ012FM | 74,42 | TRBDCMQ012FF | 144,83 |

Cuerpo H-H roscado CMF...
 Posición 1.

Cuerpo CM H-H roscado para membranas EPDM / FKM o PTFE

| d | DN | Ref. PVC-U | € | Ref. PP-H | € | Ref. PVDF | € | Ref. C-PVC | € |
|----|----|------------|------|-----------|------|-----------|-------|------------|------|
| 20 | 15 | EFV100 | 1,25 | EFM020 | 7,79 | EFF020 | 31,74 | EFC100 | 6,80 |

Tuercas CM.
 Posición 27.

Tuercas para cuerpo CM con enlaces

| d | DN | Ref. | € |
|---------|--------|--------|--------|
| 16 - 20 | 10 -15 | ATCMMN | 112,27 |

Volante CM.
 Posiciones 7-26.

| d | DN | Ref. | € |
|---------|--------|-------|-------|
| 16 - 20 | 10 -15 | BSCMX | 22,90 |

Kit Cierre CM.
 Posiciones 5-6.

Compuesto por tornillos, tuercas y tapones protectores



6,80

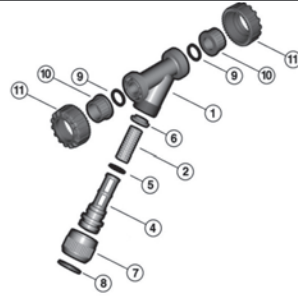

RV

Filtro inclinado RV DN10+50.

| d | DN | Ref. EPDM | € | Ref. FKM | € |
|-------|-------|-----------|-------|-----------|-------|
| 16-20 | 10-15 | SETRV020E | 3,85 | SETRV020F | 31,29 |
| 25 | 20 | SETRV025E | 5,79 | SETRV025F | 42,23 |
| 32 | 25 | SETRV032E | 5,79 | SETRV032F | 42,23 |
| 40 | 32 | SETRV040E | 9,27 | SETRV040F | 67,24 |
| 50 | 40 | SETRV050E | 9,27 | SETRV050F | 67,24 |
| 63 | 50 | SETRV063E | 13,29 | SETRV063F | 96,97 |

Juego de juntas RV. Posiciones 5-9.

| d | DN | Ref. PVC-U luz 0,3 mm. | € | Ref. PVC-U luz 0,5 mm. * | € | Ref. PVC-U luz 0,7 mm. | € | Ref. PVC-U luz 0,9 mm. | € |
|-------|-------|---------------------------|-------|-----------------------------|-------|---------------------------|-------|---------------------------|-------|
| 16-20 | 10-15 | SCR10V020 | 7,87 | SCR15V020 | 7,87 | SCR20V020 | 7,87 | SCR25V020 | 7,87 |
| 25 | 20 | SCR10V025 | 8,63 | SCR15V025 | 8,63 | SCR20V025 | 5,37 | SCR25V025 | 8,63 |
| 32 | 25 | SCR10V032 | 9,05 | SCR15V032 | 9,05 | SCR20V032 | 9,05 | SCR25V032 | 9,05 |
| 40 | 32 | SCR10V040 | 11,04 | SCR15V040 | 11,04 | SCR20V040 | 11,04 | SCR25V040 | 11,04 |
| 50 | 40 | SCR10V050 | 11,04 | SCR15V050 | 11,04 | SCR20V050 | 11,04 | SCR25V050 | 11,04 |
| 63 | 50 | SCR10V063 | 13,02 | SCR15V063 | 13,02 | SCR20V063 | 13,02 | SCR25V063 | 13,02 |

* Estándar en los filtros de PVC-U

| d | DN | Ref. PP luz 0,5 mm. ** | € | Ref. Inox luz 0,3 mm. | € |
|-------|-------|---------------------------|-------|--------------------------|-------|
| 16-20 | 10-15 | SCR15M020 | 10,62 | SCR07X020 | 9,64 |
| 25 | 20 | SCR15M025 | 11,36 | SCR07X025 | 10,30 |
| 32 | 25 | SCR15M032 | 12,28 | SCR07X032 | 11,04 |
| 40 | 32 | SCR15M040 | 13,92 | SCR07X040 | 13,02 |
| 50 | 40 | SCR15M050 | 15,50 | SCR07X050 | 13,29 |
| 63 | 50 | SCR15M063 | 18,81 | SCR07X063 | 15,72 |

Mallas RV. Posición 2.

** Estándar en los filtros de PP y C-PVC

| d | DN | Ref. PVC-U | € | Ref. PVC transparente | € |
|----|----|-------------|--------|--------------------------|--------|
| 16 | 10 | SPBDRV016DV | 23,69 | SPBDRV016DT | 28,10 |
| 20 | 15 | SPBDRV020DV | 25,88 | SPBDRV020DT | 28,10 |
| 25 | 20 | SPBDRV025DV | 32,08 | SPBDRV025DT | 34,44 |
| 32 | 25 | SPBDRV032DV | 34,44 | SPBDRV032DT | 34,44 |
| 40 | 32 | SPBDRV040DV | 50,37 | SPBDRV040DT | 50,37 |
| 50 | 40 | SPBDRV050DV | 70,49 | SPBDRV050DT | 70,49 |
| 63 | 50 | SPBDRV063DV | 104,08 | SPBDRV063DT | 115,44 |

Cuerpo M-M RVD. Posición 1.

Continúa en la página siguiente...

| d | DN | Ref. PVC-U | € | Ref. PVC transparente | € | Ref. PP-H | € | Ref. C-PVC | € |
|-------|-------|------------|--------|-----------------------|--------|------------|--------|------------|--------|
| 16-20 | 10-15 | UNBDRV020V | 25,88 | UNBDRV020T | 28,10 | UNBDRV020M | 62,09 | UNBDRV020C | 84,24 |
| 25 | 20 | UNBDRV025V | 32,08 | UNBDRV025T | 34,44 | UNBDRV025M | 66,53 | UNBDRV025C | 93,15 |
| 32 | 25 | UNBDRV032V | 34,44 | UNBDRV032T | 34,44 | UNBDRV032M | 70,97 | UNBDRV032C | 99,81 |
| 40 | 32 | UNBDRV040V | 50,37 | UNBDRV040T | 50,37 | UNBDRV040M | 75,38 | UNBDRV040C | 128,65 |
| 50 | 40 | UNBDRV050V | 70,49 | UNBDRV050T | 70,49 | UNBDRV050M | 108,62 | UNBDRV050C | 184,05 |
| 63 | 50 | UNBDRV063V | 104,08 | UNBDRV063T | 115,44 | UNBDRV063M | 126,37 | UNBDRV063C | 187,24 |

Cuerpo con enlaces RVU... Posición 1.

| d | DN | Ref. | € |
|-------|-------|----------|-------|
| 16-20 | 10-15 | SRRV020V | 6,94 |
| 25 | 20 | SRRV025V | 10,33 |
| 32 | 25 | SRRV032V | 12,92 |
| 40 | 32 | SRRV040V | 15,95 |
| 50 | 40 | SRRV050V | 19,54 |
| 63 | 50 | SRRV063V | 23,13 |

Anillo cierre RV. Posición 8.

| d | DN | Ref. PVC-U | € | Ref. PP-H | € | Ref. C-PVC | € |
|-------|-------|------------|-------|-----------|-------|------------|--------|
| 16-20 | 10-15 | SURV020V | 19,33 | SURV020M | 52,95 | SURV020C | 51,03 |
| 25 | 20 | SURV025V | 27,34 | SURV025M | 63,41 | SURV025C | 66,53 |
| 32 | 25 | SURV032V | 31,17 | SURV032M | 74,80 | SURV032C | 79,81 |
| 40 | 32 | SURV040V | 32,08 | SURV040M | 77,62 | SURV040C | 77,62 |
| 50 | 40 | SURV050V | 55,72 | SURV050M | 82,06 | SURV050C | 93,15 |
| 63 | 50 | SURV063V | 65,92 | SURV063M | 88,68 | SURV063C | 113,08 |

Soporte malla RV. Posición 4.

| d | DN | Ref. PVC-U | € | Ref. PP-H | € | Ref. C-PVC | € |
|-------|-------|------------|-------|-----------|-------|------------|-------|
| 16-20 | 10-15 | NTVKD020V | 10,22 | NTVKD020M | 13,61 | NTVKD020C | 19,54 |
| 25 | 20 | NTVKD025V | 19,33 | NTVKD025M | 25,99 | NTVKD025C | 35,78 |
| 32 | 25 | NTVKD032V | 23,37 | NTVKD032M | 31,32 | NTVKD032C | 43,92 |
| 40 | 32 | NTVKD040V | 25,09 | NTVKD040M | 34,14 | NTVKD040C | 48,78 |
| 50 | 40 | NTVKD050V | 29,68 | NTVKD050M | 40,22 | NTVKD050C | 56,94 |
| 63 | 50 | NTVKD063V | 44,95 | NTVKD063M | 61,48 | NTVKD063C | 87,79 |

Tuerca unión RV. Posición 11.

| d | DN | Ref. PVC-U | € | Ref. PP-H | € | Ref. C-PVC | € |
|-------|-------|------------|-------|-----------|-------|------------|-------|
| 16-20 | 10-15 | RRRV020V | 10,03 | RRRV020M | 15,50 | RRRV020C | 22,19 |
| 25 | 20 | RRRV025V | 13,81 | RRRV025M | 19,54 | RRRV025C | 25,51 |
| 32 | 25 | RRRV032V | 16,72 | RRRV032M | 22,79 | RRRV032C | 26,59 |
| 40 | 32 | RRRV040V | 21,90 | RRRV040M | 26,86 | RRRV040C | 28,81 |
| 50 | 40 | RRRV050V | 32,03 | RRRV050M | 30,90 | RRRV050C | 37,69 |
| 63 | 50 | RRRV063V | 39,04 | RRRV063M | 42,26 | RRRV063C | 46,57 |

Anillo sujeción RV. Posición 6.

| d | DN | Ref. PVC-U | € | Ref. PP-H | € | Ref. C-PVC | € |
|-------|-------|------------|-------|-----------|--------|------------|--------|
| 16-20 | 10-15 | BNRV020V | 26,07 | BNRV020M | 49,41 | BNRV020C | 57,65 |
| 25 | 20 | BNRV025V | 31,29 | BNRV025M | 66,48 | BNRV025C | 75,38 |
| 32 | 25 | BNRV032V | 36,10 | BNRV032M | 89,53 | BNRV032C | 93,15 |
| 40 | 32 | BNRV040V | 41,54 | BNRV040M | 97,90 | BNRV040C | 104,22 |
| 50 | 40 | BNRV050V | 48,63 | BNRV050M | 99,81 | BNRV050C | 110,90 |
| 63 | 50 | BNRV063V | 54,49 | BNRV063M | 101,97 | BNRV063C | 115,33 |

Tuerca cierre RV. Posición 7.

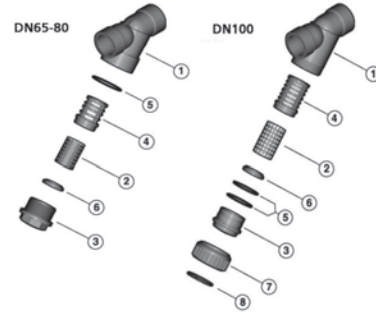

RV

Filtro inclinado RV DN65+100.

| d | DN | Ref. EPDM | € | Ref. FKM | € |
|-----|-----|-----------|-------|-----------|--------|
| 75 | 65 | SETRV075E | 17,27 | SETRV075F | 125,19 |
| 90 | 80 | SETRV090E | 30,77 | SETRV090F | 223,73 |
| 110 | 100 | SETRV110E | 38,38 | SETRV110F | 277,04 |

Juego de juntas RV. Posición 5.

| d | DN | Ref. PVC-U luz 0,3 mm. | € | Ref. PVC-U luz 0,5 mm. * | € | Ref. PVC-U luz 0,7 mm. | € | Ref. PVC-U luz 0,9 mm. | € |
|-----|-----|---------------------------|-------|-----------------------------|-------|---------------------------|-------|---------------------------|-------|
| 75 | 65 | SCR10V075 | 26,39 | SCR15V075 | 26,39 | SCR20V075 | 26,39 | SCR25V075 | 26,39 |
| 90 | 80 | SCR10V090 | 32,86 | SCR15V090 | 32,86 | SCR20V090 | 32,86 | SCR25V090 | 32,86 |
| 110 | 100 | SCR10V110 | 48,78 | SCR15V110 | 48,78 | SCR20V110 | 48,78 | SCR25V110 | 48,78 |

* Estándar en los filtros de PVC-U

| d | DN | Ref. PP luz 0,5 mm. ** | € | Ref. Inox luz 0,3 mm. | € |
|-----|-----|---------------------------|-------|--------------------------|-------|
| 75 | 65 | SCR15M075 | 25,09 | SCR07X075 | 51,84 |
| 90 | 80 | SCR15M090 | 31,78 | SCR07X090 | 60,40 |
| 110 | 100 | SCR15M110 | 46,40 | SCR07X110 | 86,15 |

Mallas RV. Posición 2.

** Estándar en los filtros de PP y C-PVC

| d | DN | Ref. PVC-U | € | Ref. PVC transparente | € | Ref. PP-H | € |
|-----|-----|-------------|--------|--------------------------|--------|-------------|--------|
| 75 | 65 | SKBDRV075IV | 189,67 | SKBDRV075IT | 256,20 | SKBDRV075IM | 425,76 |
| 90 | 80 | SKBDRV090IV | 246,59 | SKBDRV090IT | 371,80 | SKBDRV090IM | 624,47 |
| 110 | 100 | SKBDRV110IV | 418,97 | SKBDRV110IT | 569,20 | SKBDRV110IM | 830,84 |

Cuerpo H-H encolar RVI... Posición 1.

| Rh | DN | Ref. PVC-U | € | Ref. PVC transparente | € |
|-----|-----|-------------|--------|--------------------------|--------|
| 2½" | 65 | TRBDRV212FV | 189,67 | TRBDRV212FT | 256,20 |
| 3" | 80 | TRBDRV300FV | 246,59 | TRBDRV300FT | 371,80 |
| 4" | 100 | TRBDRV400FV | 418,97 | TRBDRV400FT | 569,20 |

Cuerpo H-H roscar RVI... Posición 1.

** Estándar en los filtros de PP y C-PVC

| d | DN | Ref. PVC-U | € | Ref. PP-H | € | d | DN | Ref. | € |
|-----|-----|------------|--------|-----------|--------|-----|-----|----------|-------|
| 110 | 100 | BNRV110V | 158,06 | BNRV110M | 224,54 | 110 | 100 | SRRV110V | 40,22 |

Tuerca cierre RV. Posición 7.

Anillo cierre RV. Posición 8.

| d | DN | Ref. PVC-U | € | Ref. PP-H | € |
|-----|-----|------------|-------|-----------|--------|
| 75 | 65 | RRRV075V | 71,54 | RRRV075M | 53,64 |
| 90 | 80 | RRRV090V | 74,92 | RRRV090M | 68,27 |
| 110 | 100 | RRRV110V | 94,91 | RRRV110M | 134,24 |

Anillo sujeción RV. Posición 6.

Continúa en la página siguiente...

| d | DN | Ref. PVC-U | € | Ref. PP-H | € |
|-----|-----|-----------------|---------------|-----------------|---------------|
| 75 | 65 | BORV075V | 81,29 | BORV075M | 147,85 |
| 90 | 80 | BORV090V | 96,08 | BORV090M | 177,40 |
| 110 | 100 | BORV110V | 155,24 | BORV110M | 325,26 |

Tapón RV. Posición 3.

| d | DN | Ref. PVC-U | € | Ref. PP-H | € |
|-----|-----|-----------------|--------------|-----------------|--------------|
| 75 | 65 | SURV075V | 58,56 | SURV075M | 71,57 |
| 90 | 80 | SURV090V | 74,80 | SURV090M | 74,80 |
| 110 | 100 | SURV110V | 79,70 | SURV110M | 94,91 |

Soporte malla RV. Posición 4.

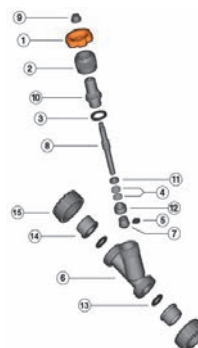

VV

Válvula de asiento inclinado VV DN10=50.

| d | DN | Ref. EPDM / PTFE | € | Ref. FKM / PTFE | € | d | DN | Ref. | € |
|-------|-------|-------------------|--------------|-------------------|---------------|-------|-------|----------------|--------------|
| 16-20 | 10-15 | SETVV020EP | 6,55 | SETVV020FP | 31,80 | 16-20 | 10-15 | HWVV020 | 10,62 |
| 25 | 20 | SETVV025EP | 8,09 | SETVV025FP | 37,61 | 25 | 20 | HWVV025 | 11,57 |
| 32 | 25 | SETVV032EP | 12,49 | SETVV032FP | 45,22 | 32 | 25 | HWVV032 | 18,49 |
| 40 | 32 | SETVV040EP | 16,61 | SETVV040FP | 65,47 | 40 | 32 | HWVV040 | 22,42 |
| 50 | 40 | SETVV050EP | 16,61 | SETVV050FP | 72,89 | 50 | 40 | HWVV050 | 28,81 |
| 63 | 50 | SETVV063EP | 16,61 | SETVV063FP | 102,92 | 63 | 50 | HWVV063 | 33,28 |

Juego de juntas VV. Posiciones 3-4-13.

Volante VV. Posiciones 1-9.

| d | DN | Ref. | € | d | DN | Ref. PVC-U | € | Ref. PVC-U / EPDM | € | Ref. PVC-U / EPDM | € |
|----|----|--------------------|---------------|----|----|-------------------|---------------|-------------------|---------------|-------------------|---------------|
| 16 | 10 | SPBDRV016DV | 23,69 | 16 | 10 | UNBDRV020V | 25,88 | ASVV020VE | 36,06 | ASVV020VF | 36,06 |
| 20 | 15 | SPBDRV020DV | 25,88 | 20 | 15 | UNBDRV020V | 25,88 | ASVV020VE | 36,06 | ASVV020VF | 36,06 |
| 25 | 20 | SPBDRV025DV | 32,08 | 25 | 20 | UNBDRV025V | 32,08 | ASVV025VE | 43,48 | ASVV025VF | 43,48 |
| 32 | 25 | SPBDRV032DV | 34,44 | 32 | 25 | UNBDRV032V | 34,44 | ASVV032VE | 50,66 | ASVV032VF | 50,66 |
| 40 | 32 | SPBDRV040DV | 50,37 | 40 | 32 | UNBDRV040V | 50,37 | ASVV040VE | 77,56 | ASVV040VF | 77,56 |
| 50 | 40 | SPBDRV050DV | 70,49 | 50 | 40 | UNBDRV050V | 70,49 | ASVV050VE | 98,11 | ASVV050VF | 98,11 |
| 63 | 50 | SPBDRV063DV | 104,08 | 63 | 50 | UNBDRV063V | 104,08 | ASVV063VE | 126,95 | ASVV063VF | 126,95 |

Cuerpo M-M VVD... Posición 6.

Cuerpo con enlaces VVU. Posición 6.

Eje VV. Posiciones 5-7-8-10-11-12.

| d | DN | Ref. PVC-U | € |
|-------|-------|------------------|--------------|
| 16-20 | 10-15 | NTVKD020V | 10,22 |
| 25 | 20 | NTVKD025V | 19,33 |
| 32 | 25 | NTVKD032V | 23,37 |
| 40 | 32 | NTVKD040V | 25,09 |
| 50 | 40 | NTVKD050V | 29,68 |
| 63 | 50 | NTVKD063V | 44,95 |

Tuerca unión VV. Posición 15.

| d | DN | Ref. PVC-U | € |
|-------|-------|-----------------|--------------|
| 16-20 | 10-15 | BNRV020V | 26,07 |
| 25 | 20 | BNRV025V | 31,29 |
| 32 | 25 | BNRV032V | 36,10 |
| 40 | 32 | BNRV040V | 41,54 |
| 50 | 40 | BNRV050V | 48,63 |
| 63 | 50 | BNRV063V | 54,49 |

Tuerca cierre VV. Posición 2.

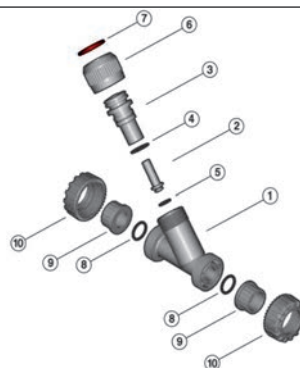

VR

Válvula anti retorno inclinada VR DN10÷50.

| d | DN | Ref. EPDM | € | Ref. FKM | € |
|-------|-------|-----------|------|-----------|-------|
| 16-20 | 10-15 | SETVR020E | 1,93 | SETVR020F | 15,72 |
| 25 | 20 | SETVR025E | 2,43 | SETVR025F | 18,91 |
| 32 | 25 | SETVR032E | 3,33 | SETVR032F | 26,78 |
| 40 | 32 | SETVR040E | 4,65 | SETVR040F | 44,68 |
| 50 | 40 | SETVR050E | 5,15 | SETVR050F | 62,61 |
| 63 | 50 | SETVR063E | 5,68 | SETVR063F | 98,54 |

Juego de juntas VR.
 Posiciones 4-5-6.

| d | DN | Ref. PVC-U | € |
|----|----|-------------|--------|
| 16 | 10 | SPBDRV016DV | 23,69 |
| 20 | 15 | SPBDRV020DV | 25,88 |
| 25 | 20 | SPBDRV025DV | 32,08 |
| 32 | 25 | SPBDRV032DV | 34,44 |
| 40 | 32 | SPBDRV040DV | 50,37 |
| 50 | 40 | SPBDRV050DV | 70,49 |
| 63 | 50 | SPBDRV063DV | 104,08 |

Cuerpo M-M VRDV.
 Posición 1.

| d | DN | Ref. | € |
|----|----|----------|-------|
| 16 | 10 | SRRV020V | 6,94 |
| 20 | 15 | SRRV020V | 6,94 |
| 25 | 20 | SRRV025V | 10,33 |
| 32 | 25 | SRRV032V | 12,92 |
| 40 | 32 | SRRV040V | 15,95 |
| 50 | 40 | SRRV050V | 19,54 |
| 63 | 50 | SRRV063V | 23,13 |

Anillo cierre VR.
 Posición 7.

| d | DN | Ref. PVC-U | € | Ref. PP-H | € |
|-------|-------|------------|--------|------------|--------|
| 16-20 | 10-15 | UNBDRV020V | 25,88 | UNBDRV020M | 62,09 |
| 25 | 20 | UNBDRV025V | 32,08 | UNBDRV025M | 66,53 |
| 32 | 25 | UNBDRV032V | 34,44 | UNBDRV032M | 70,97 |
| 40 | 32 | UNBDRV040V | 50,37 | UNBDRV040M | 75,38 |
| 50 | 40 | UNBDRV050V | 70,49 | UNBDRV050M | 108,62 |
| 63 | 50 | UNBDRV063V | 104,08 | UNBDRV063M | 126,37 |

Cuerpo con enlaces VRU...
 Posición 1.

| d | DN | Ref. PVC-U | € | Ref. PP-H | € |
|-------|-------|-----------------|--------------|-----------------|---------------|
| 16-20 | 10-15 | BOVR020V | 27,76 | BOVR020M | 52,48 |
| 25 | 20 | BOVR025V | 28,97 | BOVR025M | 61,48 |
| 32 | 25 | BOVR032V | 31,46 | BOVR032M | 78,04 |
| 40 | 32 | BOVR040V | 44,16 | BOVR040M | 104,08 |
| 50 | 40 | BOVR050V | 57,18 | BOVR050M | 109,87 |
| 63 | 50 | BOVR063V | 85,10 | BOVR063M | 117,98 |

Porta pistón VR.
Posición 3.

| d | DN | Ref. PVC-U | € | Ref. PP-H | € |
|-------|-------|------------------|--------------|------------------|--------------|
| 16-20 | 10-15 | NTVKD020V | 10,22 | NTVKD020M | 13,61 |
| 25 | 20 | NTVKD025V | 19,33 | NTVKD025M | 25,99 |
| 32 | 25 | NTVKD032V | 23,37 | NTVKD032M | 31,32 |
| 40 | 32 | NTVKD040V | 25,09 | NTVKD040M | 34,14 |
| 50 | 40 | NTVKD050V | 29,68 | NTVKD050M | 40,22 |
| 63 | 50 | NTVKD063V | 44,95 | NTVKD063M | 61,48 |

Tuerca unión VR.
Posición 10.

| d | DN | Ref. PVC-U | € | Ref. PP-H | € |
|-------|-------|-----------------|--------------|-----------------|---------------|
| 16-20 | 10-15 | BNRV020V | 26,07 | BNRV020M | 49,41 |
| 25 | 20 | BNRV025V | 31,29 | BNRV025M | 66,48 |
| 32 | 25 | BNRV032V | 36,10 | BNRV032M | 89,53 |
| 40 | 32 | BNRV040V | 41,54 | BNRV040M | 97,90 |
| 50 | 40 | BNRV050V | 48,63 | BNRV050M | 99,81 |
| 63 | 50 | BNRV063V | 54,49 | BNRV063M | 101,97 |

Tuerca cierre VR.
Posición 6.

| d | DN | Ref. PVC-U / EPDM | € | Ref. PVC-U / FKM | € | Ref. PP-H / EPDM | € | Ref. PP-H / FKM | € |
|-------|-------|-------------------|--------------|------------------|--------------|------------------|--------------|------------------|--------------|
| 16-20 | 10-15 | PSVR020VE | 24,59 | PSVR020VF | 24,59 | PSVR020ME | 24,59 | PSVR020MF | 24,59 |
| 25 | 20 | PSVR025VE | 29,29 | PSVR025VF | 29,29 | PSVR025ME | 29,29 | PSVR025MF | 29,29 |
| 32 | 25 | PSVR032VE | 31,78 | PSVR032VF | 34,02 | PSVR032ME | 31,78 | PSVR032MF | 36,20 |
| 40 | 32 | PSVR040VE | 37,53 | PSVR040VF | 41,96 | PSVR040ME | 37,53 | PSVR040MF | 46,40 |
| 50 | 40 | PSVR050VE | 47,04 | PSVR050VF | 51,69 | PSVR050ME | 47,04 | PSVR050MF | 55,89 |
| 63 | 50 | PSVR063VE | 65,63 | PSVR063VF | 71,73 | PSVR063ME | 65,63 | PSVR063MF | 74,53 |

Pistón VR.
Posiciones 2-5

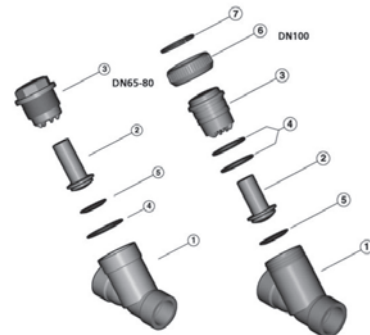

VR

Válvula anti retorno inclinada VR DN65+100

| d | DN | Ref. EPDM | € | Ref. FKM | € |
|-----|-----|------------------|--------------|------------------|---------------|
| 75 | 65 | SETVR075E | 19,20 | SETVR075F | 161,21 |
| 90 | 80 | SETVR090E | 22,79 | SETVR090F | 203,49 |
| 110 | 100 | SETVR110E | 40,70 | SETVR110F | 219,10 |

Juego de juntas VR.
Posiciones 4-5.

| d | DN | Ref. PVC-U | € | Ref. PP-H | € |
|-----|-----|------------|--------|-----------|--------|
| 75 | 65 | BOVR075V | 184,05 | BOVR075M | 206,53 |
| 90 | 80 | BOVR090V | 239,38 | BOVR090M | 340,03 |
| 110 | 100 | BOVR110V | 347,99 | | |

Porta pistón VR.

Posición 3

| d | DN | Ref. PVC-U | € | Ref. PP-H | € | Rh | DN | Ref. PVC-U | € |
|-----|-----|-------------|--------|-------------|--------|-----|-----|-------------|--------|
| 75 | 65 | SKBDVR075IV | 189,67 | SKBDVR075IM | 425,76 | 2½" | 65 | TRBDVR212FV | 189,67 |
| 90 | 80 | SKBDVR090IV | 246,59 | SKBDVR090IM | 624,47 | 3" | 80 | TRBDVR300FV | 246,59 |
| 110 | 100 | SKBDVR110IV | 418,97 | | | 4" | 100 | TRBDVR400FV | 418,97 |

Cuerpo H-H encolar VRI...

Posición 1.

Cuerpo H-H roscar VRFV...

Posición 1.

| d | DN | Ref. PVC-U / EPDM | € | Ref. PVC-U / FKM | € | Ref. PP-H / EPDM | € | Ref. PP-H / FKM | € |
|-----|-----|-------------------|--------|------------------|--------|------------------|--------|-----------------|--------|
| 75 | 65 | PSVR075VE | 154,63 | PSVR075VF | 188,12 | PSVR075ME | 203,65 | PSVR075MF | 247,17 |
| 90 | 80 | PSVR090VE | 169,95 | PSVR090VF | 285,04 | PSVR090ME | 282,98 | PSVR090MF | 406,53 |
| 110 | 100 | PSVR110VE | 226,94 | PSVR110VF | 380,60 | | | | |

Pistón VR.

Posición 2-5.

| d | DN | Ref. | € |
|-----|-----|----------|-------|
| 110 | 100 | SRRV110V | 40,22 |

Anillo cierre VR.

Posición 7.

| d | DN | Ref. PVC-U | € |
|-----|-----|------------|--------|
| 110 | 100 | BNRV110V | 158,06 |

Tuerca cierre VR.

Posición 6.

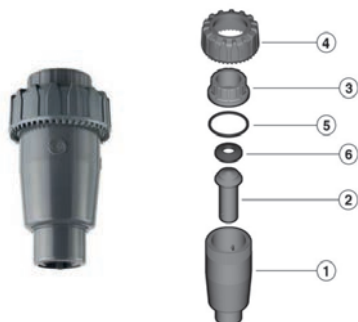

VA

Válvula de purgabola / ventosa VA.

| d | DN | Ref. EPDM | € |
|-------|-------|------------|-------|
| 16-20 | 10-15 | SETVZA020E | 2,43 |
| 25 | 20 | SETVZA025E | 3,33 |
| 32 | 25 | SETVZA032E | 4,39 |
| 40 | 32 | SETVZA040E | 6,82 |
| 50 | 40 | SETVZA050E | 14,05 |
| 63 | 50 | SETVZA063E | 16,61 |

Juego de juntas VA-VZ.

Posiciones 5-6.

| d | DN | Ref. PVC-U / EPDM | € |
|-------|-------|-------------------|-------|
| 16-20 | 10-15 | PSVA020VE | 23,37 |
| 25 | 20 | PSVA025VE | 25,75 |
| 32 | 25 | PSVA032VE | 27,94 |
| 40 | 32 | PSVA040VE | 33,86 |
| 50 | 40 | PSVA050VE | 42,42 |
| 63 | 50 | PSVA063VE | 59,29 |

Pistón VA.

Posiciones 2-6.



VZ

Válvula de fondo / pie VZ.

| d | DN | Ref. PVC-U | € |
|-------|-------|------------|-------|
| 16-20 | 10-15 | NTVKD020V | 10,22 |
| 25 | 20 | NTVKD025V | 19,33 |
| 32 | 25 | NTVKD032V | 23,37 |
| 40 | 32 | NTVKD040V | 25,09 |
| 50 | 40 | NTVKD050V | 29,68 |
| 63 | 50 | NTVKD063V | 44,95 |

Tuerca unión VA-VZ.

Posición 4.

| d | DN | Ref. PVC-U / EPDM | € |
|-------|-------|-------------------|-------|
| 16-20 | 10-15 | PSVR020VE | 24,59 |
| 25 | 20 | PSVR025VE | 29,29 |
| 32 | 25 | PSVR032VE | 31,78 |
| 40 | 32 | PSVR040VE | 37,53 |
| 50 | 40 | PSVR050VE | 47,04 |
| 63 | 50 | PSVR063VE | 65,63 |

Pistón VZ.

Posiciones 2-6.

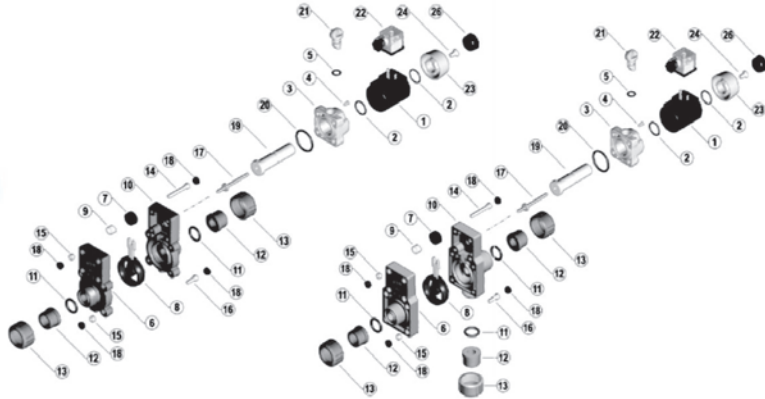

S1/S2

Válvulas de solenoide S1 y S2.

| Voltaje | Ref. para válvula S1 | € | Ref. para válvula S2 | € |
|----------|----------------------|--------|----------------------|--------|
| 24 V DC | SLS1024VDC | 126,27 | SLS2024VDC | 197,98 |
| 24 V AC | SLS1024VAC | 126,27 | SLS2024VAC | 197,98 |
| 230 V AC | SLS1230VAC | 126,27 | SLS2230VAC | 197,98 |

Solenoide.

Posición 1.

| Voltaje | Ref. | € |
|----------|------------------|-------|
| 24 V DC | CNS024VDC | 44,34 |
| 24 V AC | CNS024VAC | 44,34 |
| 110 V AV | CNS110VAC | 44,34 |
| 230 V AC | CNS230VAC | 44,34 |

Conector VA.

Posición 22.

| Válvula | Ref. | € |
|---------|--------------|------|
| S1 | SETS1 | 2,48 |
| S2 | SETS2 | 3,43 |

Juego juntas secundario.

Posiciones 2-5-20.

| Válvula | Ref.EPDM | € | Ref.FKM | € |
|---------|--------------|-------|--------------|-------|
| S1 | SHS1E | 35,78 | SHS1F | 70,51 |
| S2 | SHS2E | 38,85 | SHS2F | 89,46 |

Obturator.

Posición 8.

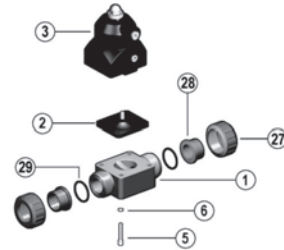

CM/CP

Válvulas de membrana compactas neumáticas CM/CP.

| d | DN | DN | Ref. Normalmente cerrado NC | € | Ref. Normalmente abierto NO | € | Ref. Doble efecto DE | € |
|-------|-------|------------|-----------------------------|------------------|-----------------------------|------------------|----------------------|------------------|
| 16-20 | 10-15 | EPDM / FKM | ATCMNC | 180,97 | ATCMNO | 180,97 | ATCMDA | 180,97 |
| 16-20 | 10-15 | PTFE | ATCMNCPQ | Consultar | ATCMNOPQ | Consultar | ATCMDAPPQ | Consultar |

Actuador neumático CM/CP.
 Posición 3.

* Estándar en los filtros de PVC-U

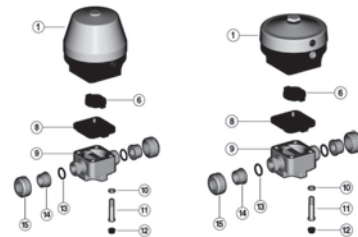

VM/CP

Válvulas de membrana neumáticas VM/CP.

| d | DN | Ref. Normalmente cerrado NC | € | Ref. Normalmente abierto NO | € | Ref. Doble efecto DE | € |
|-----|-----|-----------------------------|-----------------|-----------------------------|-----------------|----------------------|-----------------|
| 90 | 80 | ATVMNC075090 | 1.596,63 | ATVMNO075090 | 997,92 | ATVMDA075090 | 1.663,18 |
| 110 | 100 | ATVMNC110 | 2.058,60 | ATVMNO110 | 1.452,52 | ATVMDA110 | 1.663,18 |

Actuador neumático VM/CP.
 Posiciones 1-6.

| d | DN | Ref. | € |
|-----|-----|---------------------|---------------|
| 90 | 80 | COVMMN075090 | 144,15 |
| 110 | 100 | COVMMN110 | 155,24 |

Compresor VM/CP.
 Posición 6.



DK/CP

Válvula de membrana neumática DK/CP

| d | DN | Ref. EPDM | € | Ref. FKM | € | Ref. PTFE | € | Ref. NBR | € |
|----|----|-----------|-------|----------|--------|-----------|--------|----------|-------|
| 20 | 15 | DIA025E | 32,93 | DIA025F | 107,36 | DIADK025P | 127,59 | DIA025N | 32,93 |
| 25 | 20 | DIA025E | 32,93 | DIA025F | 107,36 | DIADK025P | 127,59 | DIA025N | 32,93 |
| 32 | 25 | DIA032E | 34,38 | DIA032F | 118,87 | DIADK032P | 145,52 | DIA032N | 34,38 |
| 40 | 32 | DIA032E | 34,38 | DIA032F | 118,87 | DIADK032P | 145,52 | DIA032N | 34,38 |
| 50 | 40 | DIA050E | 42,23 | DIA050F | 201,85 | DIADK050P | 240,99 | DIA050N | 42,23 |
| 63 | 50 | DIA063E | 62,61 | DIA063F | 287,98 | DIADK063P | 295,66 | DIA063N | 62,61 |
| 75 | 65 | DIA063E | 62,61 | DIA063F | 287,98 | DIADK063P | 268,16 | DIA063N | 62,61 |

Membrana DK/CP. Posición 7.

| d | DN | Ref. PVC-U | € | Ref. C-PVC | € | Ref. PP-H | € | Ref. PVDF | € |
|----|----|-------------|--------|-------------|--------|-------------|--------|-------------|--------|
| 20 | 15 | SPBDDK020DV | 38,77 | SPBDDK020DC | 56,97 | SPBDDK020DM | 52,56 | SPBDDK020DF | 155,11 |
| 25 | 20 | SPBDDK025DV | 41,78 | SPBDDK025DC | 65,77 | SPBDDK025DM | 58,47 | SPBDDK025DF | 166,67 |
| 32 | 25 | SPBDDK032DV | 56,12 | SPBDDK032DC | 89,80 | SPBDDK032DM | 82,53 | SPBDDK032DF | 205,21 |
| 40 | 32 | SPBDDK040DV | 60,01 | SPBDDK040DC | 103,58 | SPBDDK040DM | 83,06 | SPBDDK040DF | 300,12 |
| 50 | 40 | SPBDDK050DV | 73,66 | SPBDDK063DC | 140,61 | SPBDDK063DM | 168,39 | SPBDDK050DF | 367,34 |
| 63 | 50 | SPBDDK063DV | 96,67 | SPBDDK050DC | 135,08 | SPBDDK050DM | 140,37 | SPBDDK063DF | 494,50 |
| 75 | 65 | SPBDDK075DV | 135,30 | SPBDDK075DC | 196,86 | SPBDDK075DM | 235,74 | SPBDDK075DF | 692,29 |

Cuerpo M-M DK/CP. Posición 8.

| d | DN | Ref. PVC-U | € | Ref. C-PVC | € | Ref. PP-H | € | Ref. PVDF | € |
|----|----|------------|--------|------------|--------|------------|--------|------------|--------|
| 20 | 15 | UNBDDK020V | 41,15 | UNBDDK020C | 98,85 | UNBDDK020M | 91,72 | UNBDDK020F | 164,51 |
| 25 | 20 | UNBDDK025V | 45,96 | UNBDDK025C | 111,85 | UNBDDK025M | 98,46 | UNBDDK025F | 183,42 |
| 32 | 25 | UNBDDK032V | 62,30 | UNBDDK032C | 151,36 | UNBDDK032M | 124,60 | UNBDDK032F | 227,78 |
| 40 | 32 | UNBDDK040V | 69,40 | UNBDDK040C | 175,39 | UNBDDK040M | 138,86 | UNBDDK040F | 335,68 |
| 50 | 40 | UNBDDK050V | 93,07 | UNBDDK050C | 221,58 | UNBDDK050M | 177,26 | UNBDDK050F | 385,96 |
| 63 | 50 | UNBDDK063V | 118,92 | UNBDDK063C | 265,32 | UNBDDK063M | 219,61 | UNBDDK063F | 522,79 |

Cuerpo con enlaces DKU/CP. Posición 8.

| d | DN | Ref. PVC-U | € | Ref. C-PVC | € | Ref. PP-H | € | Ref. PVDF | € |
|----|----|-------------|--------|-------------|--------|-------------|--------|-------------|--------|
| 20 | 15 | FLBDDK020OV | 102,81 | FLBDDK020OC | 173,75 | FLBDDK020OM | 144,81 | FLBDDK020OF | 356,62 |
| 25 | 20 | FLBDDK025OV | 116,24 | FLBDDK025OC | 203,55 | FLBDDK025OM | 158,47 | FLBDDK025OF | 373,76 |
| 32 | 25 | FLBDDK032OV | 145,68 | FLBDDK032OC | 241,63 | FLBDDK032OM | 201,27 | FLBDDK032OF | 432,82 |
| 40 | 32 | FLBDDK040OV | 180,33 | FLBDDK040OC | 296,56 | FLBDDK040OM | 244,58 | FLBDDK040OF | 686,64 |
| 50 | 40 | FLBDDK050OV | 227,36 | FLBDDK050OC | 358,29 | FLBDDK050OM | 305,12 | FLBDDK050OF | 769,60 |
| 63 | 50 | FLBDDK063OV | 282,78 | FLBDDK063OC | 445,52 | FLBDDK063OM | 383,48 | FLBDDK063OF | 990,67 |

Cuerpo con bridas DIN DKO/CP. Posición 8.

| d | DN | Ref. PVC-U | € | Ref. C-PVC | € | Ref. PP-H | € | Ref. PVDF | € |
|--------|----|--------------|--------|--------------|--------|--------------|--------|--------------|--------|
| 1/2" | 15 | FLBDDK012OAV | 96,70 | FLBDDK012OAC | 163,40 | FLBDDK012OAM | 136,20 | FLBDDK012OAF | 257,96 |
| 3/4" | 20 | FLBDDK034OAV | 109,37 | FLBDDK034OAC | 191,42 | FLBDDK034OAM | 149,04 | FLBDDK034OAF | 270,40 |
| 1" | 25 | FLBDDK100OAV | 137,01 | FLBDDK100OAC | 227,25 | FLBDDK100OAM | 189,28 | FLBDDK100OAF | 313,06 |
| 1 1/4" | 32 | FLBDDK114OAV | 169,56 | FLBDDK114OAC | 278,88 | FLBDDK114OAM | 229,98 | FLBDDK114OAF | 496,70 |
| 1 1/2" | 40 | FLBDDK112OAV | 213,83 | FLBDDK112OAC | 336,92 | FLBDDK112OAM | 286,93 | FLBDDK112OAF | 556,67 |
| 2" | 50 | FLBDDK200OAV | 265,88 | FLBDDK200OAC | 418,94 | FLBDDK200OAM | 360,62 | FLBDDK200OAF | 716,60 |

Cuerpo con bridas ANSI 150 lbs DKO/CP. Posición 8.

Continúa en la página siguiente...

| d | DN | Referencia | € | d | DN | Ref.NC | € | Ref.NO | € | Ref.DE | € |
|----|----|---------------------|--------------|----|----|---------------------|------------------|---------------------|---------------|---------------------|---------------|
| 20 | 15 | CODK020025 | 20,55 | 20 | 15 | ATDKNC020025 | 253,83 | ATDKNO020025 | 225,38 | ATDKDA020025 | 162,71 |
| 25 | 20 | CODK020025 | 20,55 | 25 | 20 | ATDKNC020025 | 253,83 | ATDKNO020025 | 225,38 | ATDKDA020025 | 162,71 |
| 32 | 25 | CODK032040 | 22,47 | 32 | 25 | ATDKNC032040 | Consultar | ATDKNO032040 | 226,99 | ATDKDA032040 | 353,07 |
| 40 | 32 | CODK032040 | 22,47 | 40 | 32 | ATDKNC032040 | Consultar | ATDKNO032040 | 226,99 | ATDKDA032040 | 353,07 |
| 50 | 40 | COVMMN040050 | 28,69 | 50 | 40 | ATDKNC050 | 428,79 | ATDKNO050 | 292,59 | ATDKDA050 | 265,99 |
| 63 | 50 | COVMMN063 | 37,21 | 63 | 50 | ATDKNC063075 | 664,40 | ATDKNO063075 | 417,68 | ATDKDA063075 | 379,73 |
| 75 | 65 | COVMMN063 | 37,21 | 75 | 65 | ATDKNC063075 | 664,40 | ATDKNO063075 | 417,68 | ATDKDA063075 | 379,73 |

Compresor DK. Posición 6.

Actuador neumático DK/CP. Posiciones 1-2-3-4-6.

| d | DN | Referencia | € | d | DN | Referencia | € |
|----|----|--------------------|--------------|--|-------|----------------------|------------------|
| 20 | 15 | BSDK020025X | 27,34 | 20+75 | 15+65 | TCSDKCP020075 | Consultar |
| 25 | 20 | BSDK020025X | 27,34 | Tapón transparente DK. Posiciones 1-2-3. | | | |
| 32 | 25 | BSDK032040X | 35,90 | | | | |
| 40 | 32 | BSDK032040X | 35,90 | | | | |
| 50 | 40 | BSDK050X | 40,90 | | | | |
| 63 | 50 | BSDK063075X | 51,20 | | | | |
| 75 | 65 | BSDK063075X | 51,20 | | | | |

Cierres DK. Posiciones 12-13-14.



DKB/CP

Válvulas de membrana compactas neumáticas CM/CP.



| d | DN | Ref. EPDM | € |
|----|----|----------------|--------------|
| 20 | 15 | DIA025E | 32,93 |
| 25 | 20 | DIA025E | 32,93 |
| 32 | 25 | DIA032E | 34,38 |
| 40 | 32 | DIA032E | 34,38 |
| 50 | 40 | DIA050E | 42,23 |
| 63 | 50 | DIA063E | 62,61 |
| 75 | 65 | DIA063E | 62,61 |

Membrana DKB/CP. Posición 7.

| d | DN | Ref. EPDM | € |
|----|----|----------------------|---------------|
| 20 | 15 | ATDKBNC020025 | 252,06 |
| 25 | 20 | ATDKBNC020025 | 252,06 |
| 32 | 25 | ATDKBNC032040 | 268,14 |
| 40 | 32 | ATDKBNC032040 | 268,14 |
| 50 | 40 | ATDKBNC050 | 353,87 |
| 63 | 50 | ATDKBNC063075 | 495,68 |
| 75 | 65 | ATDKBNC063075 | 495,68 |

Actuador neumático DKB/CP. Posiciones 1-6.

| d | DN | Ref. PVC-U | € | Ref. C-PVC | € | Ref. PP-H | € |
|----|----|--------------------|---------------|--------------------|---------------|--------------------|---------------|
| 25 | 15 | SPBDDK020DV | 38,77 | SPBDDK020DC | 56,97 | SPBDDK020DM | 52,56 |
| 32 | 25 | SPBDDK025DV | 41,78 | SPBDDK040DC | 103,58 | SPBDDK025DM | 58,47 |
| 50 | 40 | SPBDDK032DV | 56,12 | SPBDDK032DC | 89,80 | SPBDDK032DM | 82,53 |
| 40 | 32 | SPBDDK040DV | 60,01 | SPBDDK025DC | 65,77 | SPBDDK040DM | 83,06 |
| 20 | 20 | SPBDDK050DV | 73,66 | SPBDDK063DC | 140,61 | SPBDDK050DM | 140,37 |
| 63 | 50 | SPBDDK063DV | 96,67 | SPBDDK050DC | 135,08 | SPBDDK063DM | 168,39 |
| 75 | 65 | SPBDDK075DV | 135,30 | SPBDDK075DC | 196,86 | SPBDDK075DM | 235,74 |

Cuerpo M-M DKB/CP. Posición 8.

| d | DN | Ref. PVC-U | € | Ref. C-PVC | € | Ref. PP-H | € |
|----|----|------------|--------|------------|--------|------------|--------|
| 20 | 15 | UNBDDK020V | 41,15 | UNBDDK020C | 98,85 | UNBDDK020M | 91,72 |
| 25 | 20 | UNBDDK025V | 45,96 | UNBDDK025C | 111,85 | UNBDDK025M | 98,46 |
| 32 | 25 | UNBDDK032V | 62,30 | UNBDDK032C | 151,36 | UNBDDK032M | 124,60 |
| 40 | 32 | UNBDDK040V | 69,40 | UNBDDK040C | 175,39 | UNBDDK040M | 138,86 |
| 50 | 40 | UNBDDK050V | 93,07 | UNBDDK050C | 221,58 | UNBDDK050M | 177,26 |
| 63 | 50 | UNBDDK063V | 118,92 | UNBDDK063C | 265,32 | UNBDDK063M | 219,61 |

Cuerpo con enlaces DKBU/CP. Posición 8.

| d | DN | Ref. PVC-U | € | Ref. C-PVC | € | Ref. PP-H | € |
|----|----|-------------|--------|-------------|--------|-------------|--------|
| 20 | 15 | FLBDDK020OV | 102,81 | FLBDDK020OC | 173,75 | FLBDDK020OM | 144,81 |
| 25 | 20 | FLBDDK025OV | 116,24 | FLBDDK025OC | 203,55 | FLBDDK032OM | 201,27 |
| 32 | 25 | FLBDDK032OV | 145,68 | FLBDDK032OC | 241,63 | FLBDDK025OM | 158,47 |
| 40 | 32 | FLBDDK040OV | 180,33 | FLBDDK040OC | 296,56 | FLBDDK050OM | 305,12 |
| 50 | 40 | FLBDDK050OV | 227,36 | FLBDDK050OC | 358,29 | FLBDDK040OM | 244,58 |
| 63 | 50 | FLBDDK063OV | 282,78 | FLBDDK063OC | 445,52 | FLBDDK063OM | 383,48 |

Cuerpo con bridas DIN DKBO/CP. Posición 8.

| d | DN | Ref. PVC-U | € | Ref. C-PVC | € | Ref. PP-H | € |
|------|----|--------------|--------|--------------|--------|--------------|--------|
| ½" | 15 | FLBDDK012OAV | 96,70 | FLBDDK012OAC | 163,40 | FLBDDK012OAM | 136,20 |
| ¾" | 20 | FLBDDK034OAV | 109,37 | FLBDDK034OAC | 191,42 | FLBDDK034OAM | 149,04 |
| 1" | 25 | FLBDDK100OAV | 137,01 | FLBDDK100OAC | 227,25 | FLBDDK100OAM | 189,28 |
| 1 ¼" | 32 | FLBDDK114OAV | 169,56 | FLBDDK114OAC | 278,88 | FLBDDK114OAM | 229,98 |
| 1 ½" | 40 | FLBDDK112OAV | 213,83 | FLBDDK112OAC | 336,92 | FLBDDK112OAM | 286,93 |
| 2" | 50 | FLBDDK200OAV | 265,88 | FLBDDK200OAC | 418,94 | FLBDDK200OAM | 360,62 |

Cuerpo con bridas ANSI 150 lbs DKBO/CP. Posición 8.

| d | DN | Ref. EPDM | € |
|----|----|-------------|-------|
| 20 | 15 | BSDK020025X | 27,34 |
| 25 | 20 | BSDK020025X | 27,34 |
| 32 | 25 | BSDK032040X | 35,90 |
| 40 | 32 | BSDK032040X | 35,90 |
| 50 | 40 | BSDK050X | 40,90 |
| 63 | 50 | BSDK063075X | 51,20 |
| 75 | 65 | BSDK063075X | 51,20 |

Mcierres DKB. Posición 12-13-14.

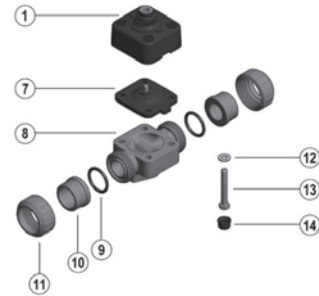

DKD/CP

Válvulas de membrana neumática DKD/CP.

| d | DN | Ref. EPDM | € |
|----|----|------------|-----------|
| 20 | 15 | DIADKD025E | Consultar |
| 25 | 20 | DIADKD025E | Consultar |
| 32 | 25 | DIA032E | 34,38 |
| 40 | 32 | DIA032E | 34,38 |
| 50 | 40 | DIA050E | 42,23 |
| 63 | 50 | DIA063E | 62,61 |
| 75 | 65 | DIA063E | 62,61 |

Membrana DKD / CP. Posición 7.

| d | DN | Ref. PVC-U | € |
|----|----|-------------|--------|
| 20 | 15 | SPBDDK020DV | 38,77 |
| 25 | 20 | SPBDDK025DV | 41,78 |
| 32 | 25 | SPBDDK032DV | 56,12 |
| 40 | 32 | SPBDDK040DV | 60,01 |
| 50 | 40 | SPBDDK050DV | 73,66 |
| 63 | 50 | SPBDDK063DV | 96,67 |
| 75 | 65 | SPBDDK075DV | 135,30 |

Cuerpo DKDD...
 Posición 8.

M-M encolar

| d | DN | Ref. PVC-U | € |
|----|----|------------|--------|
| 20 | 15 | UNBDDK020V | 41,15 |
| 25 | 20 | UNBDDK025V | 45,96 |
| 32 | 25 | UNBDDK032V | 62,30 |
| 40 | 32 | UNBDDK040V | 69,40 |
| 50 | 40 | UNBDDK050V | 93,07 |
| 63 | 50 | UNBDDK063V | 118,92 |

Cuerpo DKDU...
 Posición 8.

H-H encolar con enlaces

| d | DN | Ref. | € |
|-------|-------|-------------|-------|
| 20÷25 | 15÷20 | BODKD020025 | 36,81 |
| 32÷40 | 25÷32 | BODKD032040 | 39,22 |
| 50 | 40 | BODKD050 | 65,31 |
| 63÷75 | 50÷65 | BODKD063075 | 95,03 |

Cubierta DKD/CP.
 Posición 1.

| d | DN | Ref. | € |
|-------|-------|-------------|-------|
| 20÷25 | 15÷20 | BSDK020025X | 27,34 |
| 32÷40 | 25÷32 | BSVM020032X | 37,69 |
| 50 | 40 | BSVM040050X | 44,34 |
| 63÷75 | 50÷65 | BSVM063X | 55,54 |

Cierres DKD/CP.
 Posiciones 12-13-14.



Parte LOCA



Parte FIJA



TUERCA



PVC-U



PP-H



C-PVC



PVDF

Bl...

Uniones 3 piezas en PVC-U.

| d | Ref. | € |
|-----|---------|-------|
| 16 | QBIV016 | 0,71 |
| 20 | QBIV020 | 0,71 |
| 25 | QBIV025 | 0,74 |
| 32 | QBIV032 | 0,93 |
| 40 | QBIV040 | 1,06 |
| 50 | QBIV050 | 1,45 |
| 63 | QBIV063 | 1,93 |
| 75 | QBIV075 | 4,57 |
| 90 | QBIV090 | 5,81 |
| 110 | QBIV110 | 11,28 |

Parte loca. H encolar.

| d | Ref. | € |
|-----|---------|-------|
| 16 | FBIV016 | 0,93 |
| 20 | FBIV020 | 0,93 |
| 25 | FBIV025 | 1,11 |
| 32 | FBIV032 | 1,59 |
| 40 | FBIV040 | 1,87 |
| 50 | FBIV050 | 2,53 |
| 63 | FBIV063 | 3,75 |
| 75 | FBIV075 | 10,45 |
| 90 | FBIV090 | 13,47 |
| 110 | FBIV110 | 19,96 |

Parte fija. H encolar.

| d | Ref. | € |
|-----|--------|-------|
| 16 | EFV034 | 0,94 |
| 20 | EFV100 | 1,25 |
| 25 | EFV114 | 2,64 |
| 32 | EFV112 | 2,85 |
| 40 | EFV200 | 3,31 |
| 50 | EFV214 | 2,85 |
| 63 | EFV234 | 5,12 |
| 75 | EFV312 | 21,55 |
| 90 | EFV400 | 29,87 |
| 110 | EFV500 | 39,22 |

Tuerca. H rosacar.

| Rh | Ref. | € |
|--------|---------|-------|
| 3/8" | QBFV038 | 3,37 |
| 1/2" | QBFV012 | 4,54 |
| 3/4" | QBFV034 | 5,37 |
| 1" | QBFV100 | 9,88 |
| 1 1/4" | QBFV114 | 10,30 |
| 1 1/2" | QBFV112 | 12,09 |
| 2" | QBFV200 | 15,90 |

Parte loca. H rosacar.

| Rh | Ref. | € |
|--------|---------|-------|
| 3/8" | FBFV038 | 4,86 |
| 1/2" | FBFV012 | 5,91 |
| 3/4" | FBFV034 | 6,63 |
| 1" | FBFV100 | 8,88 |
| 1 1/4" | FBFV114 | 10,83 |
| 1 1/2" | FBFV112 | 15,72 |
| 2" | FBFV200 | 20,41 |

Parte fija. H rosacar.

Uniones 3 piezas en PP-H.

| d | Ref. | € |
|----|----------|------|
| 20 | QBIGM020 | 4,34 |
| 25 | QBIGM025 | 4,39 |
| 32 | QBIGM032 | 4,70 |
| 40 | QBIGM040 | 5,81 |
| 50 | QBIGM050 | 6,94 |
| 63 | QBIGM063 | 7,40 |

Parte loca. H soldar.

| d | Ref. | € |
|----|----------|-------|
| 20 | FBIGM020 | 8,43 |
| 25 | FBIGM025 | 9,27 |
| 32 | FBIGM032 | 10,62 |
| 40 | FBIGM040 | 13,86 |
| 50 | FBIGM050 | 19,65 |
| 63 | FBIGM063 | 26,12 |

Parte fija. H soldar.

| d | Ref. | € |
|----|---------|-------|
| 20 | EFGM100 | 8,27 |
| 25 | EFGM114 | 8,56 |
| 32 | EFGM112 | 9,93 |
| 40 | EFGM200 | 12,68 |
| 50 | EFGM214 | 19,65 |
| 63 | EFGM234 | 31,66 |

Tuerca. H rosacar.

Continúa en la página siguiente...



Parte LOCA



Parte FIJA



TUERCA



PVC-U



PP-H



C-PVC



PVDF

Uniones 3 piezas en C-PVC.

| d | Ref. | € |
|----|---------|-------|
| 16 | QBIC016 | 10,22 |
| 20 | QBIC020 | 10,17 |
| 25 | QBIC025 | 11,89 |
| 32 | QBIC032 | 15,45 |
| 40 | QBIC040 | 18,96 |
| 50 | QBIC050 | 29,75 |
| 63 | QBIC063 | 33,67 |

Parte loca. *H* encolar.

| d | Ref. | € |
|----|---------|-------|
| 16 | FBIC016 | 8,48 |
| 20 | FBIC020 | 8,58 |
| 25 | FBIC025 | 9,85 |
| 32 | FBIC032 | 14,39 |
| 40 | FBIC040 | 18,44 |
| 50 | FBIC050 | 24,33 |
| 63 | FBIC063 | 28,99 |

Parte fija. *H* encolar.

| d | Ref. | € |
|----|--------|-------|
| 16 | EFC034 | 8,16 |
| 20 | EFC100 | 6,80 |
| 25 | EFC114 | 7,92 |
| 32 | EFC112 | 15,26 |
| 40 | EFC200 | 17,36 |
| 50 | EFC214 | 28,45 |
| 63 | EFC234 | 45,29 |

Tuerca. *H* roscar.

| Rh | Ref. | € |
|--------|---------|-----------|
| 3/8" | QBFC038 | Consultar |
| 1/2" | QBFC012 | 17,29 |
| 3/4" | QBFC034 | 19,20 |
| 1" | QBFC100 | 22,58 |
| 1 1/4" | QBFC114 | 26,44 |
| 1 1/2" | QBFC112 | 29,84 |
| 2" | QBFC200 | 40,41 |

Parte loca. *H* roscar.

| Rh | Ref. | € |
|--------|---------|-------|
| 3/8" | FBFC038 | 9,74 |
| 1/2" | FBFC012 | 11,67 |
| 3/4" | FBFC034 | 13,31 |
| 1" | FBFC100 | 17,90 |
| 1 1/4" | FBFC114 | 21,13 |
| 1 1/2" | FBFC112 | 29,29 |
| 2" | FBFC200 | 40,64 |

Parte fija. *H* roscar.

Uniones 3 piezas en PVDF.

| d | Ref. | € |
|----|----------|-------|
| 20 | QBIGF020 | 16,80 |
| 25 | QBIGF025 | 21,73 |
| 32 | QBIGF032 | 24,22 |
| 40 | QBIGF040 | 30,90 |
| 50 | QBIGF050 | 35,21 |
| 63 | QBIGF063 | 48,83 |

Parte loca. *H* soldar.

| d | Ref. | € |
|----|----------|-------|
| 20 | FBIGF020 | 24,94 |
| 25 | FBIGF025 | 32,62 |
| 32 | FBIGF032 | 35,92 |
| 40 | FBIGF040 | 46,22 |
| 50 | FBIGF050 | 62,36 |
| 63 | FBIGF063 | 97,75 |

Parte fija. *H* soldar.

| d | Ref. | € |
|----|---------|--------|
| 20 | EFGF100 | 27,71 |
| 25 | EFGF114 | 37,79 |
| 32 | EFGF112 | 46,88 |
| 40 | EFGF200 | 64,44 |
| 50 | EFGF214 | 94,00 |
| 63 | EFGF234 | 146,16 |

Tuerca. *H* roscar.

Juntas para uniones 3 piezas



| d | Ref. | € |
|-----|---------|-------|
| 16 | OR3062E | 2,01 |
| 20 | OR4081E | 5,73 |
| 25 | OR4112E | 2,06 |
| 32 | OR4131E | 2,94 |
| 40 | OR6162E | 3,12 |
| 50 | OR6187E | 3,31 |
| 63 | OR6237E | 3,62 |
| 75 | OR6300E | 7,24 |
| 90 | OR6362E | 10,83 |
| 110 | OR6450E | 14,29 |

Junta tórica. En EPDM.



| d | Ref. | € |
|-----|---------|-------|
| 16 | OR3062F | 4,93 |
| 20 | OR4081F | 15,16 |
| 25 | OR4112F | 2,85 |
| 32 | OR4131F | 8,05 |
| 40 | OR6162F | 11,89 |
| 50 | OR6187F | 13,54 |
| 63 | OR6237F | 15,16 |
| 75 | OR6300F | 28,37 |
| 90 | OR0185F | 31,09 |
| 110 | OR6450F | 51,69 |

Junta tórica. En FKM.



FC/FS

Flujómetros cortos (FC) y largos (FS).

| d | DN | Ref. SS para líquidos | € | Ref. SS + M para líquidos | € | Ref. PP para líquidos | € | Ref. PP + M para líquidos | € |
|--------------|----|-----------------------|--------|---------------------------|--------|-----------------------|--------|---------------------------|--------|
| 16 | 10 | FL016X | 42,65 | FL016XM | 131,79 | FL016M | 42,65 | FL016MM | 131,79 |
| 20 | 15 | FL020X | 46,48 | FL020XM | 151,14 | FL020M | 46,48 | FL020MM | 151,14 |
| 25 | 20 | FL025X | 52,34 | FL025XM | 156,95 | FL025M | 52,31 | FL025MM | 156,95 |
| 32 | 25 | FL032X | 58,13 | FL032XM | 193,74 | FL032M | 58,13 | FL032MM | 193,74 |
| 40 | 32 | FL040X | 108,52 | FL040XM | 251,90 | FL040M | 108,52 | FL040MM | 251,90 |
| 50 | 40 | FL050X | 135,64 | FL050XM | 290,65 | FL050M | 135,64 | FL050MM | 290,65 |
| 63 | 50 | FL063X | 213,13 | FL063XM | 387,55 | FL063M | 213,13 | FL063MM | 387,55 |
| 75 | 65 | FL075X | 437,90 | FL075XM | 817,69 | FL075M | 437,90 | FL075MM | 817,69 |
| 75 cuerpo 68 | 65 | FL07568X | 437,90 | FL07568XM | 817,69 | FL07568M | 437,90 | FL07568MM | 817,69 |

| d | DN | Ref. PP para gases | € | Ref. PP + M para gases | € |
|----|----|--------------------|--------|------------------------|--------|
| 16 | 10 | FL016GM | 42,65 | FL016GMM | 131,79 |
| 20 | 15 | FL020GM | 46,48 | FL020GMM | 151,14 |
| 25 | 20 | FL025GM | 52,34 | FL025GMM | 156,95 |
| 32 | 25 | FL032GM | 58,13 | FL032GMM | 193,74 |
| 40 | 32 | FL040GM | 108,52 | FL040GMM | 251,90 |
| 50 | 40 | FL050GM | 135,64 | FL050GMM | 290,65 |
| 63 | 50 | FL063GM | 213,13 | FL063GMM | 387,55 |
| 75 | 65 | FL075GM | 437,90 | FL075GMM | 817,69 |

Flotador FC y FS. Posición 8.

| d | DN | Ref.Serie FC | € | Ref.Serie FS | € |
|--------------|----|--------------|-------|--------------|--------|
| 16 | 10 | STFC016P | 26,20 | | |
| 20 | 15 | STFC020P | 26,20 | | |
| 25 | 20 | STFC025P | 27,17 | STFS025P | 27,17 |
| 32 | 25 | STFC032P | 29,74 | STFS032P | 29,74 |
| 40 | 32 | | | STFS040P | 42,84 |
| 50 | 40 | | | STFS050P | 46,80 |
| 63 | 50 | | | STFS063P | 58,42 |
| 75 | 65 | | | STFS075PINF | 110,82 |
| 75 cuerpo 68 | 65 | | | STFS075PSUP | 110,82 |

Topes flotador FC y FS. Posición 7.

Se necesita 1 pieza para la serie FC y 2 piezas para la serie FS (precio por unidad)

Continúa en la página siguiente...

| Ref. | Descripción | € |
|--------------|---|-------------|
| VFI01 | Indicadores visuales para FS y FC d 32 (2 piezas) | 3,85 |
| VFI02 | Indicadores visuales para FC 16, 20 y d 25 (2 piezas) | 3,85 |

Indicadores visuales de caudal FC y FS.

Posición 2.



| d | Ref. | € |
|----|----------------|-------------|
| 16 | OR3062E | 2,01 |
| 20 | OR4081E | 5,73 |
| 25 | OR4112E | 2,06 |
| 32 | OR4131E | 2,94 |
| 40 | OR0150E | 4,17 |
| 50 | OR4200E | 3,70 |
| 63 | OR4275E | 5,76 |
| 75 | OR6325E | 9,32 |

Junta tórica en EPDM.

Posición 6.



| d | Ref. | € |
|----|----------------|--------------|
| 16 | OR3062F | 4,93 |
| 20 | OR4081F | 15,16 |
| 25 | OR4112F | 2,85 |
| 32 | OR4131F | 8,05 |
| 40 | OR0150F | 15,87 |
| 50 | OR4200F | 12,39 |
| 63 | OR4275F | 19,70 |
| 75 | OR6325F | 31,61 |

Junta tórica en FKM.

Posición 6.

No se trata solo de lo que hacemos, sino de **cómo lo hacemos**. Desde la **sostenibilidad y el compromiso social**, compartimos un mismo propósito de generar un impacto positivo en el mundo.

Transformando comunidades a través de soluciones innovadoras

Reducimos el impacto en nuestro entorno a través de **prácticas responsables y respetuosas** con el medio ambiente.

Nuestro proyecto de desarrollo sostenible



Contribuimos con los siguientes Objetivos de Desarrollo Sostenible:



NOTA: Los datos facilitados en este catálogo, como consecuencia de la constante mejora y evolución de nuestros productos, pueden variar sin previo aviso.

Este catálogo no tiene carácter contractual, y toda la información se da de buena fe.

Declinamos cualquier responsabilidad derivada de la aplicación de los mismos.

La versión más actualizada de este catálogo la encontrará disponible en nuestra página web.

Normas Generales

PRECIOS: Los precios son de VENTA AL PÚBLICO (Recomendados) y pueden ser modificados sin previo aviso. Los precios no incluyen IVA.

EXPEDICIONES Y PEDIDOS: Para importes inferiores a 300€ se cobrará una tasa administrativa de 8€. La mercancía viaja siempre por cuenta y riesgo del comprador. Los pedidos serán siempre de cajas o camiones completos, en función de la naturaleza del producto y acuerdos comerciales. Las unidades mínimas de venta recogidas en la presente tarifa son de obligado cumplimiento, así como la venta por múltiplos de esta, conforme a los acuerdos comerciales en vigor. En caso que ALIAXIS IBERIA S.A.U. autorice enviar unidades sueltas, tendrán un recargo del 20% en concepto de manipulación.

PORTES: Los pedidos superiores a 600€, dentro de la Península disfrutarán de portes gratuitos. En el caso de Canarias los pedidos superiores a 1.500€ estarán igualmente exentos de cargo de portes.

Puede consultar los cargos por portes en el siguiente link: www.aliaxis.es/condicionescomerciales.

ALIAXIS IBERIA S.A.U. gestionará los envíos a las direcciones correspondientes al domicilio habitual del comprador. En caso, de necesitar un envío a la dirección de un tercero, se aplicará el correspondiente cargo por portes a terceros. Este importe puede consultarse en el siguiente enlace: www.aliaxis.es/condicionescomerciales

ANULACIONES DE PEDIDOS: No se admiten anulaciones de pedidos que ya estén fabricados, en curso de fabricación o sobre los que ya se haya emitido albarán para su envío y por tanto estén en transporte.

DEVOLUCIONES DE MATERIAL: No se admiten devoluciones de material, salvo por defecto imputable a la fabricación o a la gestión del transporte, en este último caso el comprador deberá inspeccionar las mercancías de forma inmediata tras su recepción. Cualquier desperfecto reconocible en el transcurso de la inspección rutinaria y que sea asumible por el transporte, deberá notificarse a ALIAXIS IBERIA S.A.U. por email en un plazo máximo de 3 días laborables tras su recepción, no pudiendo ser atendidas las reclamaciones que excedan ese periodo.

CONDICIONES DE ENTREGA: Los pedidos podrán ser suministrados y facturados en parte sin que ello suponga la anulación de los mismos.

CALIDAD Y GARANTÍA: La garantía de nuestros materiales queda limitada a la reposición del producto, modelo o pieza que sea reconocida como defectuosa. Igualmente cubre todos los daños a terceros mediante póliza de responsabilidad civil, siempre y cuando se hayan observado las especificaciones y prescripciones para su uso correcto e instalación descritas en la documentación técnica del producto. Dado las características de los materiales cualquier reclamación de calidad, deberá plantearse dentro de los 15 días naturales siguientes a la entrega del material. Cualquier utilización o uso de nuestros materiales para fines distintos a los que fueron fabricados eximirá de cualquier tipo de responsabilidad.

PAGOS: Los precios de la tarifa están considerados para pagos al contado. No obstante, previa clasificación del comprador, se podrá optar a otras condiciones de mercado en el marco de las normas vigentes, entre ellas la Ley 15/2010 de medidas contra la morosidad en las operaciones comerciales. Los pagares y cheques tan solo se consideran aceptados por ALIAXIS IBERIA S.A.U. en el momento en el que se hagan efectivos, no constituyendo en ningún caso la entrega de los mismos el cumplimiento de la obligación correspondiente.

Anexo 1: En caso de que la mora, la insolvencia o las deudas por parte del comprador hagan peligrar la solvencia de ALIAXIS IBERIA S.A.U. estará facultada para exigir de forma inmediata la liquidación de todas las cantidades adeudadas o la provisión de garantías, tanto en ese momento como en futuros. ALIAXIS IBERIA S.A.U. podrá realizar únicamente las entregas pendientes en caso de que estas se hayan abonado por adelantado o se hayan presentado las garantías suficientes. En caso de que el comprador no pueda cumplir lo anterior en un periodo razonable de tiempo ALIAXIS IBERIA S.A.U. podrá rescindir el contrato de venta.

COMERCIALIZACIÓN: El comprador se compromete a no vender, transferir, transbordar o disponer de ninguna otra manera de los Productos (i) a individuos y/o entidades objeto de sanciones financieras o económicas; y/o (ii) con conocimiento o razón para creer que el comprador y/o usuario final puede utilizar los productos para cualquier uso final prohibido (como en relación con armas nucleares, químicas o biológicas o misiles, cualquier otro uso final militar en un país sujeto a un embargo de armas o como piezas para artículos militares). Además, el comprador se compromete a proporcionar a ALIAXIS IBERIA S.A.U. cualquier información necesaria para cumplir con las leyes y regulaciones de control y/o sanciones de exportación.

RESERVA DE PROPIEDAD: ALIAXIS IBERIA S.A.U. conservará la propiedad de las mercancías suministradas hasta que se abone el pago total del correspondiente precio de compra y se liquiden la totalidad de las deudas pendientes por parte del comprador a ALIAXIS IBERIA S.A.U. En los casos especificados en el Anexo 1, ALIAXIS IBERIA S.A.U. también podrá impedir la tramitación y la reventa de la mercancía entregada con efectos inmediatos. Una declaración de rescisión del contrato por parte de ALIAXIS IBERIA S.A.U. también se considerará una anulación de la autorización para revender y cobrar los derechos de reventa. En estos, caso ALIAXIS IBERIA S.A.U. también podrá exigir la devolución inmediata de las mercancías entregadas por cuenta del comprador.

PROHIBICIÓN DE CESIÓN: El comprador tan solo podrá ceder los derechos y las deudas dimanantes de contratos de venta a terceros con el consentimiento previo de ALIAXIS IBERIA S.A.U.

RESERVA: Nos reservamos el derecho a introducir modificaciones de diseño, medidas y unidades de embalaje en nuestros fabricados sin previo aviso.

COMPETENCIA JUDICIAL: Para resolver las cuestiones que puedan derivarse de la aplicación de estas Normas, tanto ALIAXIS IBERIA S.A.U. como comprador, convienen someterse a los Juzgados y Tribunales pertinentes renunciando a su propio fuero si fuese otro.

LIMITACIONES: Queda prohibida la reproducción total o parcial de esta tarifa sin la autorización expresa de ALIAXIS IBERIA S.A.U. Esta tarifa está sujeta a modificación sin previo aviso, todos los datos y especificaciones técnicas expresadas, se dan de buena fe y no tienen carácter contractual. Declinamos cualquier responsabilidad derivada de la aplicación de los mismos.

Somos la fuerza de todas nuestras marcas locales y un equipo global



Aliaxis Iberia, S.A.U.

C/ del Yen, s/n - Pol. Las Atalayas
03114 Alicante, España
+34 965 109 044

alixis.es

Empresa registrada según normas



Encuentra aquí nuestra
tarifa actualizada

